

VOL 4



THE REHAB GUIDE

WINDOWS & DOORS



PATH (Partnership for Advancing Technology in Housing) is a new private/public effort to develop, demonstrate, and gain widespread market acceptance for the "Next Generation" of American housing. Through the use of new or innovative technologies the goal of PATH is to improve the quality, durability, environmental efficiency, and affordability of tomorrow's homes.

Initiated at the request of the White House, PATH is managed and supported by the Department of Housing and Urban Development (HUD). In addition, all Federal Agencies that engage in housing research and technology development are PATH Partners, including the Departments of Energy and Commerce, as well as the Environmental Protection Agency (EPA) and the Federal Emergency Management Agency (FEMA). State and local governments and other participants from the public sector are also partners in PATH. Product manufacturers, home builders, insurance companies, and lenders represent private industry in the PATH partnership.

To learn more about PATH, please contact:

PATH
Suite B133
451 Seventh Street, SW
Washington, DC 20410
202-708-4250 (fax)
e-mail: pathnet@pathnet.org
website: www.pathnet.org

DISCLAIMER

The statements and conclusions contained in this report are those of Steven Winter Associates, Inc. and do not necessarily reflect the views of the Department of Housing and Urban Development. Steven Winter Associates, Inc. has made every effort to verify the accuracy and appropriateness of the report's content. However, no guarantee of the accuracy or completeness of the information or acceptability for compliance with any industry standard or mandatory requirement of any code, law, or regulation is either offered or implied. The products listed in the report are included only as examples of some available products. No endorsement, recommendation, or evaluation of these products or their use is given or implied.

FOREWORD

President Clinton recognizes that research and technological innovation are crucial if America is to meet its affordable housing needs. In 1998, the President introduced a major new initiative: The Partnership for Advancing Technology in Housing (PATH). This initiative brings together leaders from the home building, product manufacturing, insurance, and financial industries, as well as representatives from federal agencies, to spur housing design and construction innovations.

Thanks to the development of new machinery and materials and the creation of new technologies and techniques, the construction industry has made great progress. But a breakthrough material, a labor-saving tool, or a cost-cutting technique is only valuable if it is widely adopted, which means the construction industry must first become aware of these new developments.

The Department of Housing and Urban Development can help. We have commissioned a set of guidebooks that will present state-of-the-art techniques, materials, and technologies for housing rehabilitation. This volume, *Windows & Doors*, is the fourth of nine guidebooks—known collectively as *The Rehab Guide*—that will appear over the next few years.

We are presenting these guidebooks because, like research and technological innovation, housing rehabilitation is an essential component of America's commitment to provide affordable housing. I am pleased to present this important publication in the hope that it will become a valuable resource that leads to affordable, high quality rehabilitation, and thus to better housing for all Americans.



Andrew Cuomo, Secretary
U.S. Department of Housing and Urban Development

THE REHAB GUIDE: WINDOWS & DOORS

INTRODUCTION

This series of guidebooks has been produced by the U.S. Department of Housing and Urban Development to keep the design and construction industry abreast of innovations and state-of-the-art practices in home rehabilitation. As is too often the case, innovative techniques, materials, technologies, and products are slow to make their way into accepted practice. It is evident that such innovations will not advance unless the industry is made aware of them and they are tested. *The Rehab Guide* is intended to accelerate this process by informing builders, architects, engineers, and other housing rehabilitation professionals about such innovations and state-of-the-art practices.

The Rehab Guide was also prompted by the lack of a comprehensive publication to make the design and construction industry aware of innovative and cost-saving developments in housing rehabilitation. Professional trade magazines, conferences, and trade shows offer some dissemination of this information, but they are rarely focused exclusively on housing rehabilitation, as this series is, nor are they comprehensive.

FOCUS OF THE REHAB GUIDE

The focus of this series is on housing rehabilitation, which is different than home improvement. Rehabilitate means "to restore to good condition," not necessarily to improve to a state that is significantly different than the original. This is a fine line, but it distinguishes this series from "home improvement" books written for the amateur. *The Rehab Guide* focuses on building technology, materials, components, and techniques rather than "projects" such as adding a new room, converting a garage into a den, or finishing an attic. Nor is *The Rehab Guide* intended to be a "diagnostic" tool; a number of such books are already available to the industry.

The content for this guidebook, *Windows & Doors*, has been gathered from professionals in the housing rehabilitation field; manufacturers and suppliers of innovative technologies, materials, components, tools, and equipment; trade shows, conferences, reports, and publications considering such issues; trade organizations; and building research centers.

A NOTE ON SOURCES

A variety of excellent resources exists for information on windows. One very comprehensive book on windows is titled *Residential Windows: a Guide to New Technologies and Energy Performance*, published by W. W. Norton & Company and developed with the support of the U.S. Department of Energy's Window and Glazing Research Program within the Office of Building Technology, State and Community Programs. Another notable source specific to the repair of existing windows is the New York Landmarks Conservancy *Repairing Old and Historic Windows; A Manual for Architects and Homeowners*. DOE also publishes *Fact Sheets*, which summarize the principles involved in the selection of windows. Natural Resources

Canada publishes a *Consumer's Guide to Buying Energy-Efficient Windows and Doors*, which is suitable for cold climates.

Other valuable and detailed sources of information include technical trade magazines such as *Construction Specifier*, *Doors and Hardware*, *Fenestration*, *Window & Door Fabricator*. *Remodeling* magazine's bi-annual *Buyer's Guide* provides a very comprehensive list of manufacturer products categorized by application. Publications relating more directly to residential construction include the *Energy Design Update*, *Environmental Building News*, *Fine Homebuilding*, *Journal of Light Construction*, *Home Energy*, *Old House Journal*, *This Old House*, and *Traditional Builder*.

HOW THE GUIDE IS ORGANIZED

Nine volumes will eventually make up *The Rehab Guide* in its entirety, and they are listed on the back cover of this volume. Each one is devoted to distinct elements of the house, and within each volume is a range of issues that are common to that element of home rehabilitation work. This volume, *Windows & Doors*, for example, covers topics from new materials for the repair of existing frames to the criteria for selection of an entirely new window or door unit. Each volume addresses a wide range of techniques, materials, tools, and recommendations based on regional differences around the country. Throughout *The Rehab Guide* special attention is given to issues related to energy efficiency, accessible design, and sustainability.

EASILY ACCESSIBLE FORMAT

The Rehab Guide is written and presented in a format intended for easy use. The spiral bound volumes open flat so that they can be easily photocopied, and they can be assembled and stored in a single three-ring binder. Within each volume, drawings, photos, and other graphic materials supplement written descriptions of a broad range of items: state-of-the-art and innovative building technology, products, materials, components, construction and management techniques, tools, equipment, software—virtually any and all items that make housing rehabilitation more efficient in terms of cost and time. While the content focuses on present technologies and techniques that are currently part of the house-building industry, *The Rehab Guide* also includes information on materials, products, and procedures from other construction sectors (such as commercial, industrial, institutional) that are relevant to housing rehabilitation.

The information is organized in different sections according to rehab subjects, and under headings that make this book easy to understand. "Essential Knowledge" gives the reader a basic overview of the important issues related to the section heading. Next, "Techniques, Materials, Tools" presents state-of-the-art and innovative approaches to accomplishing the work. Each entry is explained in detail, including its advantages and disadvantages. This makes it easy for readers to compare approaches and choose the one that is most applicable to their particular project. By design, the "Techniques, Materials, Tools" section is an overview, not a detailed description of implementation. "Further Reading" lists the valuable resources relevant to the subject that readers can go to for more detailed information. Finally, "Product Information" provides names and addresses of manufacturers of products, materials, systems, and components mentioned in the text so that more information can be obtained. By virtue of their being listed here, such products are not necessarily being recommended; their existence and availability is being brought to the reader's attention. New products should be carefully evaluated in the field as to their performance. The product lists are not necessarily comprehensive, and we encourage readers to bring new materials and products to our attention to be included in later editions of *The Rehab Guide*.

EXISTING WINDOW & DOOR OVERVIEW

Windows and doors are openings in the building envelope that often have multiple and contradictory performance requirements. Windows and doors serve not only as barriers but as a mediator, providing access but preventing entry of the elements, allowing views and ventilation but also protection from the weather. Door and window selection is a balancing of desired objectives including performance, function, appearance, and cost.

Window and door performance, particularly in terms of energy conservation, has progressed significantly in the last two decades as new, better performing materials have been introduced. Issues regarding materials, manufacture, finishes, and performance of doors and windows are similar, and the discussion of such issues within this guide is usually applicable to both.

2.1

EVALUATION OF EXISTING CONDITIONS, OPTIONS, AND SELECTION

The focus of this guide is to restore windows and doors and improve performance by means of new and innovative products. The repair of existing windows and doors, in combination with improvements such as adding a storm or screen unit and insulating the perimeter of the opening, often proves to be the most cost effective solution. The rehabilitation of a door may simply require the adjustment of a loose hinge or strike plate and the replacement of worn weatherstripping. However, the cost of skilled labor and the conveniences provided by new technologies may justify the use of an entirely new unit or some combination of repair and new components.

New window technology has resulted in dramatic savings and increased comfort for the homeowner with the use of new or reformulated frame materials and glazing products while requiring significantly less maintenance. However, a recent study conducted by the State of Vermont concluded the energy savings realized between a renovated window with a storm unit and a replacement unit, without the benefit of high-performance glass products (such as low-e or spectrally selective) were very similar. Infiltration rates (the exchange of air) between the renovated and replacement units were also comparable. The benefits of replacement will not necessarily be energy savings, but the opportunity to provide a more comfortable, durable window or door with ease of operation and the elimination of a lead paint hazard.

Initially an evaluation should be made as to the extent of repair or replacement required. There are essentially three progressive options in addition to repair and storm units, which are discussed separately: a replacement window sash or door; a secondary pre-assembled unit; and complete unit replacement. The first two partial replacement methods provide many of the benefits of a new window or door without disturbing the existing frame, trim, or the surrounding surfaces but do not address infiltration (leaks) at the perimeter, often a major source of energy loss and discomfort. A replacement window sash or door requires the existing frame to be in good condition and relatively square. If either of these con-

ditions does not exist a new sash or door will not operate properly. A secondary frame is suitable for openings that are not square, but these reduce the opening size, and the existing frame opening must be in good condition. Complete replacement provides the opportunity to improve the perimeter insulation as well as to inspect the existing construction for damage. Partial and total replacement units are available in custom sizes. Replacement units are also available in incremental stock sizes, which reduces lead time but often may require infill trim to enclose the existing opening.

The selection of a window should consider the appearance, building type, climate, durability, orientation, expected use, and all applicable codes. A single window type may not be applicable to the entire house. Manufacturers have begun to label their windows as orientation and climate specific to achieve optimal performance. Windows that face east or north or sources of noise (such as traffic) generally should have higher insulative values. Windows in either coastal areas or high altitudes must resist higher wind loads, differential pressures, and corrosive elements. A multi-story building such as a townhouse or apartment building will require low maintenance, ease of cleaning, and resistance to higher wind pressures. Historic buildings will require a matching appearance with existing materials and profiles.

Codes may require replacement window units to have minimum energy performance, safety and egress requirements, and the ability to withstand natural hazards such as wind. Building codes require safety glass, either tempered or laminated, to be installed where there is a potential for human impact. A replacement window must also comply with egress requirements in the size of the clear opening and the sill height above the floor for sleeping rooms in a home of three stories or less. Utilities, insurance companies, and financial institutions may also provide incentives to homeowners to choose units with better performance or safety in the form of premium savings or reduced rate mortgages. In addition to these factors, door selection should also consider fire resistance requirements as prescribed by the building code.

Although not generally required of single-family homes, accessibility for the disabled may often be readily provided for doors and windows. Various accessibility regulations govern the design and construction of residential, typically multi-family, buildings. There are several prescriptive requirements, but *Accessible and Usable Buildings and Facilities* (ANSI A117.1) is the most prevalent. Where local codes differ from the national specification the more stringent requirements should be utilized. There are numerous products available for rehab to make homes accessible (see Further Reading for sources).

2.2

WINDOW AND DOOR TYPES

Window types may generally be categorized as either fixed, sliding, pivot, or hinged, with the distinction among the many varieties described by their typical application (Fig. 1). A hinged window is either a casement, awning, or hopper according to its operation. An individual window unit may have combined properties such as a single hung window that has a fixed and sliding sash, or a projecting window with a fixed and hinged sash.

Door types may be hinged, sliding, pivot, or some variation thereof (Fig. 2). A hinged door may be described as either a passage, accordion, side hinge folding, or bi-fold. An example of a pivot door, often confused with hinged units, in a residential application is a kitchen door that swings in both directions and does not require the use of a latch. Sliding doors are either by-passing, surface sliding, or pocket sliding.

Doors are also categorized by their method of construction, such as panel, batten, or flush. Traditional wood panel doors are made of horizontal rails and vertical stiles that frame one or more panels. Batten doors are usually constructed of solid lumber in a series of planks that are secured with a board attached diagonally on the surface. Flush doors have interior structural cores covered with a thin surface material. This interior structure may be composed of either rails and stiles with hollow cavities or a solid monolithic material such as rigid insulation, particle board, or engineered (jointed) wood members. The exterior surface may be a variety of materials, including metal, plastic laminate, wood (veneer, hardboard, plywood), and fiberglass. The expressive form of a wood panel door can be simulated by flush

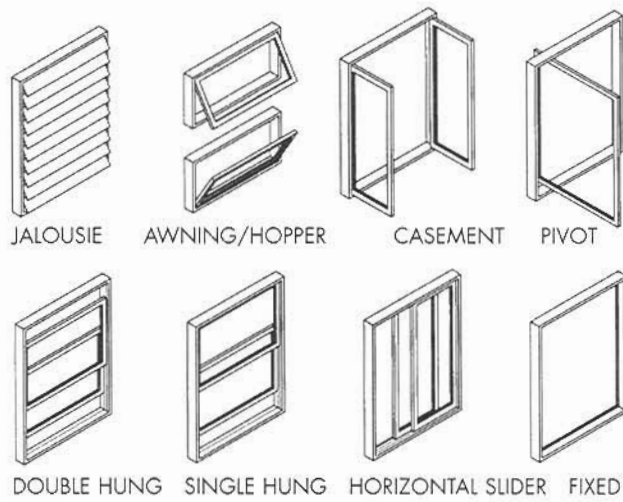

FIGURE 1

WINDOW TYPES

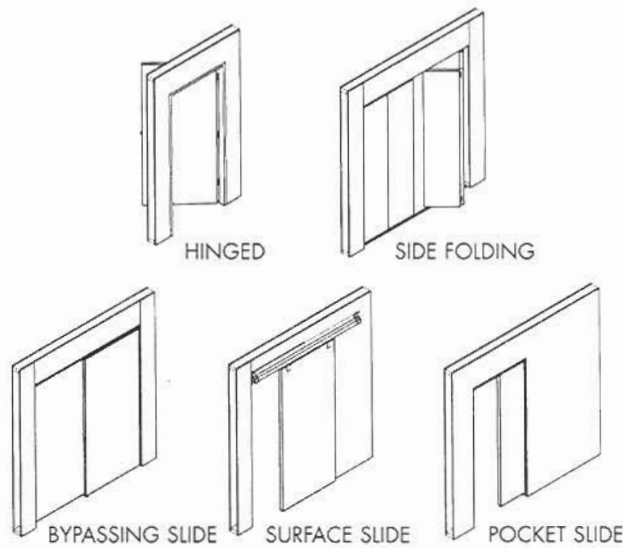

FIGURE 2

DOOR TYPES

doors with either formed (negative relief) panels or the addition of built up (positive relief) materials to achieve similar profiles, textures, and the appearance of wood, often with the ability to be stained.

Door installation previously required the precision skills of a cabinet maker; the door constructed and hung on site had to be installed absolutely square and plumb in order to operate properly with repeated use. Today, the door and frame are usually pre-assembled by either the factory, distributor, or lumber yard. Such pre-hung doors, which may also be pre-drilled for hardware, have greatly simplified door installation. Pre-hung doors are also available with two-piece (split) or knock down frames, with attached trim and adjustable thresholds, for rapid installation in an out-of-square opening. A pre-hung insert door, similar to a secondary window frame, may be inserted within the frame of an existing door. However, the opening will be smaller, which may not be desirable or code compliant.

Hinged windows and doors, in comparison with sliding units, generally provide a tighter air seal and have less air and water leakage rates because of locking mechanisms, compression gaskets, and stronger frames. They also permit a full opening for egress and ventilation. However, the swing of hinged windows and doors may be an obstruction. Alternatively, bi-fold or accordion style doors provide access

with a minimum of space consumed. Sliding doors consume minimum space but allow only half the width of the opening for clearance. Sliding units typically use a brush type weather-seal subject to wear and tear and a shorter service life. Pocket doors permit the full width of an opening to be used, but may prove inconvenient to operate and are best suited for locations where they are infrequently operated. Ultimately, the performance of a particular unit is determined by the quality of design, construction, and materials—all of which are often difficult to evaluate by visual inspection alone.

Advances in window and door materials over time have balanced the unique qualities of materials for optimum performance. Wood, the oldest window frame material, requires more maintenance than others but is undergoing a transformation with reformulation as a composite and is being used with the protective cladding of aluminum, vinyl, and fiberglass. Wood windows and doors have remained popular because this material is easy to modify in the field for the installation of hardware, or for future adjustment. Steel doors can be coated with vinyl films to give them the appearance of wood grains and to accept stain. Aluminum, often selected for its strength and ease of manufacture and maintenance, is a poor choice in colder climates because of its conductive qualities, which transmit cold outdoor temperatures through the frame (Fig. 3). Window manufacturers responded to this deficit by combining aluminum with less conductive materials such as plastic to provide a “thermal break.” Vinyl windows have enjoyed larger market acceptance in recent years for both new and rehab applications.

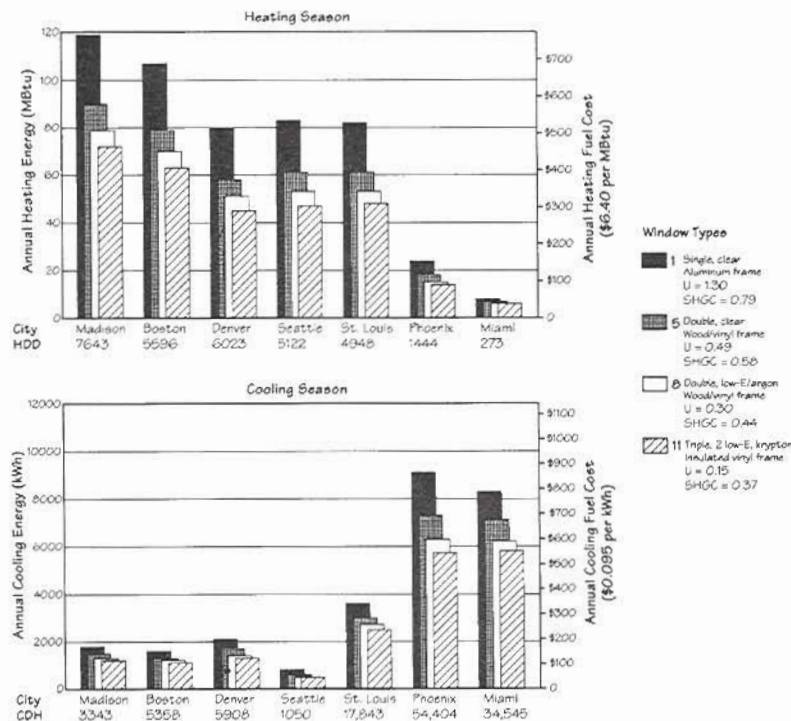

Note: The annual energy performance figures shown here are for a typical 1540 sq ft house. U-factor and SHGC are for total window including frame. House and windows are described in Appendix A. MBtu=millions of Btu, kWh=kilowatt hours. HDD=heating degree days. CDH=cooling degree hours.

FIGURE 3

COMPARISON OF SEASONAL HEATING AND COOLING COST FOR FOUR WINDOW TYPES

2.3

RATINGS AND STANDARDS

The selection of windows and doors based on energy performance criteria has been simplified with the establishment of uniform rating procedures established by the National Fenestration Rating Council (NFRC). The NFRC is a non-profit public/private organization, comprised of a diversified group which includes man-

ufacturers, utilities, code authorities, and others, and sanctioned by the Energy Policy Act of 1992.

Through the NFRC Certification Program, participating manufacturers obtain certification authorization for total product energy ratings such as the U-Value, solar heat gain coefficient, and visible transmittance. Door labels provide the U-Value only. It is anticipated that in late 1998 NFRC will also have certified ratings for both a heating rating and cooling rating. NFRC is presently working on future rating systems for air infiltration, condensation resistance, and long-term energy performance. The values are determined by licensed independent laboratories accredited by the NFRC correlating the results of computer simulations and actual physical testing for two different prescribed sizes. The performance data for both sizes, which vary by type, are designated as "AA" - Residential and "BB" - Non-Residential and are identified on the label.

The ratings for each individual product can be found on the product itself in the form of an NFRC Temporary Label (Fig. 4), and also with a permanent marking somewhere on the unit. The energy performance ratings of manufacturers participating in the NFRC Certification Program can also be found in the NFRC Certified Products Directory, which is published annually.

Presently seven states—California, Idaho, Massachusetts, Minnesota, Oregon, Washington, and Wisconsin—and some local jurisdictions require NFRC ratings for new windows (including those used in rehab) as well as the 1995 Model Energy Code.



FIGURE 4

NFRC TEMPORARY LABEL

Windows or doors should also be selected by their respective performance class designation, which is their ability to resist wind pressure, water, and air infiltration, and resistance to forced entry. The Window and Door Manufacturers Association (WDMA) and the American Architectural Manufacturer's Association (AAMA) have recently developed a new voluntary standard for aluminum, vinyl, and wood windows and glass doors (AAMA/NWDA 101/I.S.2-97). The new standard combines the two national window performance standards ANSI/AAMA 101.93 and NWDA I.S. 2.93 and will be applicable to new materials such as composites and plastics.

This standard uses a design pressure designation in lieu of the former structural test pressure value such as grade 20, 40, and 60. Minimum criteria have been established for five performance classes, the lowest of which is "Residential." A new designation code identifies the product type, performance class, performance grade, and maximum size unit tested. Additional voluntary standards, such as acousti-

cal performance, thermal resistance and condensation resistance may also be evaluated by this standard. This new standard, commonly employed in the selection of commercial window and door units, allows for the selection of products for specific applications.

2.4

INSTALLATION

The selection of a suitable window or door does not ensure performance: a unit is only as good as its installation. Improper or inadequate anchorage of the unit will defeat the wind and weather resistance of the best performing window or door. Installation of a replacement window or door may require modification of an existing opening for squareness, caulking, fastening securely to structural members, and insulation of gaps with a product prescribed by the manufacturer.

A common problem encountered is rough openings not large enough to allow for expansion of unit and structural movement, in particular the space required to accommodate header deflection. Out-of-square installation will also impair the proper functioning of the unit and result in a poor weather seal. A window or door that is not functioning properly or has deteriorated may be an indication of damage elsewhere. Windows or doors that are difficult to operate may be swollen due to the effects of moisture that has leaked from a remote area such as the roof and has traveled through the wall cavity only to be discovered at the opening. Often such leaks are present for some time and rot may extend throughout the wall framing. Replacement of water damaged windows offers an opportunity to explore the cause and to examine framing members, which may be structurally compromised.

A window or door without proper structural support will not operate properly and will be subject to infiltration around the perimeter. Insulating between the unit and the rough opening is critical to ultimate performance. Batt insulation or injectable non-expansive foam are the two most popular means of filling this gap. Care must be exercised during installation of batt insulation that it is not too loose (permitting air flow) or too tight (reducing the thermal resistance). Foam products must be installed so as not to apply pressure to the unit itself (which can distort the frame) or chemically interact with the frame material.

Installing new windows and doors also presents the opportunity to eliminate airborne lead and peeling paint from lead based paints, typically present in homes built before 1978. Moving sashes and doors grind the paint into dust, which is easily transported by air movement. Typically, a window requiring lead abatement will cost about the same as a new sash replacement unit. However, replacement of the entire unit will require removal of trim, which is another potential source of lead contamination. The removal of lead-based paint requires precautions that are beyond the scope of this guidebook (see Further Reading for more information on lead-based paints and mitigation methods).

The American Society for Testing and Materials (ASTM) is presently developing a window and door installation standard that will provide a consensus document for the installation of windows, doors, and skylights. This standard will likely serve as the comprehensive reference for both specification and instructional purposes.

2.5

COSTS AND BENEFITS

The repair and/or replacement of windows and doors can pay for itself through improved energy performance and can provide increased comfort. Reduced drafts and warmer surfaces will permit lower temperature settings. However, beware of the enthusiastic promises of manufacturers who may overstate the value of a product. All improvements may be evaluated on a payback basis of their potential savings relative to

cost. Potential savings may also include incentives provided by local government or utilities and special financing referred to as an Energy Efficient Mortgage (EEM) that enables the homeowner to finance the cost of the improvement at no additional net operational cost (mortgage plus utilities). The NFRC certified ratings for U-Factor and Solar Heat Gain Coefficient may be considered for use when using computer simulation programs to assess the potential economic benefit new windows and doors will have on the energy performance of a home. RESFEN, a computer program for the purpose of calculating the annual heating and cooling energy use and cost due to window selection, is available from the Lawrence Berkeley National Laboratory. Fax a request to Resfen Request at 510-486-4089 or e-mail your request to ploss@lbl.gov. The Department of Energy (DOE) intends to provide an interactive version of this software program in the near future at the Efficient Windows Collaborative web site (www.efficientwindows.org).

FURTHER READING

Accessible Housing by Design: Universal Design Principles in Practice, Steven Winter Associates, New York: McGraw-Hill, 1997.

ASHRAE Handbook of Fundamentals, Atlanta, GA: American Society of Heating, Refrigerating and Air Conditioning Engineers, 1997.

"Choosing a Front Door," Rich Ziegner, *Fine Homebuilding*, No. 90.

"Choosing Replacement Windows," *Journal of Light Construction* (New England Edition), February 1993.

Choosing the Best Window for Hot Climates, R. McCluney, Florida Solar Energy Center, 1993.

"Creating Windows of Energy-Saving Opportunity," Andrew M. Shapiro and Brad James, *Home Energy*, September/October 1997.

Designing Low-Energy Buildings: Passive Solar Strategies and Energy-10 Software, Passive Solar Industries Council, Washington, DC, Passive Solar Industries Council, 1996.

"Energy-Efficient Window Retrofits: Install with Care," James O'Bannon and Andre Grieco, *Home Energy*, January/February 1997.

Guidelines for the Evaluation and Control of Lead-Based Paint Hazards in Housing, Washington, DC: U.S. Department of Housing and Urban Development, 1995.

"Historic Metal Windows: Their Architectural History," Elan Zingman-Leith, *Old-House Journal*, November 1986.

The Passive Solar Design and Construction Handbook, Steven Winter Associates, New York: John Wiley & Sons, 1998.

Repairing Old and Historic Windows: A Manual for Architects and Homeowners, New York Landmarks Conservancy, New York: John Wiley & Sons, 1992.

Residential Windows, John Carmody, Stephen Selkowitz & Lisa Hescong, New York: W.W. Norton, 1996.

Residential Window and Door Installation Guide, Association of Window and Door Installers, 11300 U.S. Highway 1, Suite 400, North Palm Beach, FL 33408-3296.

"Shopping for Entry Doors," Clayton DeKorne, *Journal of Light Construction* (New England Edition), December 1991.

"Shopping for Replacement Windows," Marylee MacDonald, *Journal of Light Construction*, June 1989.

"Shopping for Wood Windows," Charles Wardell, *Journal of Light Construction*, June 1994.

"Taking a Look at Windows," Jefferson Kolle, *Fine Homebuilding*, No. 97.

Twentieth Century Building Materials: History and Conservation, Thomas C. Jester, New York: McGraw-Hill, 1995.

"Understanding Energy-Efficient Windows," Paul Fiset, *Fine Homebuilding*, February/March 1998.

"Windows: Looking through the Options," Alex Wilson, *Environmental Building News*, March/April 1996.

"Window Technology Update," Alex Wilson, *Journal of Light Construction* (New England Edition), December 1991.

"Worrisome Windows," Paul Engstrom and Jeanne Huber, *This Old House*, January/February 1997.

PRODUCT INFORMATION

Andersen Windows, 100 North 4th Avenue, Bayport, MN 55003-1096; 800-426-4261; www.andersen-corp.com (wood, vinyl clad, and composite wood windows and doors).

Caradco, P.O. Box 920, Rantoul, IL 61866; 217-893-4444 (wood, alum. clad, and vinyl windows and doors).

CertainTeed Corporation, P.O. Box 860, Valley Forge, PA 19482; 800-233-8990; www.certainteed.com (vinyl windows and doors).

Comfort Line Inc., 5500 Enterprise Boulevard, Toledo, OH 43612; 800-522-4999 (wood, composite wood, vinyl, and fiberglass windows and doors).

Hope's Architectural Products, 84 Hopkin's Avenue, Jamestown, NY; 716-665-5124; (metal (steel) framed windows).

Hurd Millwork, 520 South Whelan Avenue, Medford, WI 54451; 715-748-2011 (wood, alum. clad, and vinyl windows and doors).

Jeld-Wen Window Products (Pozzi, Wenco, Norco, Caradco), P.O. Box 1329, Klamath Falls, OR 97601-0268; 800-877-9482; www.doors-windows.com (wood, alum. clad, composite wood, vinyl, and fiberglass windows and doors).

Kolbe and Kolbe, 1323 S. Eleventh Avenue, Wausau, WI 54401-5998, 800-955-8177, www.kolbe-kolbe.com (wood and alum. clad windows and doors).

Marvin Windows, P.O. Box 100, Warroad, MN 56763; 800-346-5128; www.marvin.com (wood, alum. clad, composite wood, and fiberglass windows and doors).

Milgard Windows, 1010 54th Ave. E., Tacoma, WA 98424; 800-645-4273 (wood, vinyl, and fiberglass windows and doors).

Omniglass, 1205 Sherwin Road, Winnipeg, MB R3H 0V1; 204-987-8522 (composite wood and fiberglass windows).

Pella Corporation, 102 Main Street, Pella, IA 50219; 800-847-3552; www.pella.com (wood and alum. clad windows and doors).

Seekircher Steel Window Repair, 630 Saw Mill River Rd., Ardsley, NY 10502; 914-693-1920 (metal framed window repair).

Torrance Steel Window Co., Inc., 1819 Abalone Ave., Torrance, CA 90501; 310-328-9181 (metal framed windows).

Weather Shield Manufacturing, Inc., P.O. Box 309, Medford, WI 54451; 800-222-2995; www.weather-shield.com (wood, alum. clad, vinyl clad, and vinyl windows and doors).

ESSENTIAL KNOWLEDGE

The performance of windows has increased significantly since the energy crisis of the 1970's with the use of multiple glazing layers and new glazing technology. Such insulating glass provides air space(s) between the layers to reduce the transmission of heat, cold, and sound through the window assembly. This space is typically filled with air or inert gases such as argon or krypton, to further reduce the heat transmission. New glazing coatings and films enable windows to selectively transmit the majority of visible light but reflect heat and ultra-violet (UV) radiation. Such glazing can reduce heating and/or cooling costs (total solar transmittance), lighting costs (visible light), damage to contents subject to UV degradation, and can improve comfort.

Single-glazed windows with storms and screens have steadily lost market share since 1965 to insulating glass, which now represents approximately 90% of all new window glazing in the U.S. A window with a low U-value (such as 0.33) or, inversely, a high R-value (such as 3.0) will reduce the transmission of heat and save energy. In addition to reducing the heating/cooling demand, a well insulated window will minimize the effects of thermal air movement associated with drafts and greatly reduce the potential for condensation on the window or door, which can progressively deteriorate some frame materials, as well as surrounding wall finishes and furnishings. Insulating glass units have a limited lifetime due to the vulnerability of the seals, and are typically warranted for 10 to 20 years. A better performing window will not only often pay for itself but will provide increased comfort to the inhabitant.

Glazing also has a visible transmittance value—a measure of how much of the light is perceived to pass through it. Glazing with a high visible transmittance is generally desirable in most areas because it allows a clear view through the window with minimal distortion or tint and reduces the need for lighting. There are many types of low-emissivity (low-e) coatings. All low-e coatings improve the U-value but they can be formulated to have varying solar heat gain coefficients (SHGC). Selecting the best type of low-e for your condition represents a trade-off between the ability to reject unwanted heat from the sun during cooling periods and accepting heat during heating periods. Selection must be made for geographic region and window orientation. A low-e coating is typically placed on the interior surface of glazing for protection and attached to the surface closest to the source of heat to be reflected, either surface #2 for cooling climates or #3 for heating climates (Fig. 1). Some very high performance window units use multiple coatings on either additional glazing layers or intermediary plastic films to achieve a cumulative effect. As of 1996, low-e coatings were used on 40% of all new windows. This percentage is anticipated to rise now that the industry has developed the capacity to produce such coatings at a very small cost premium.

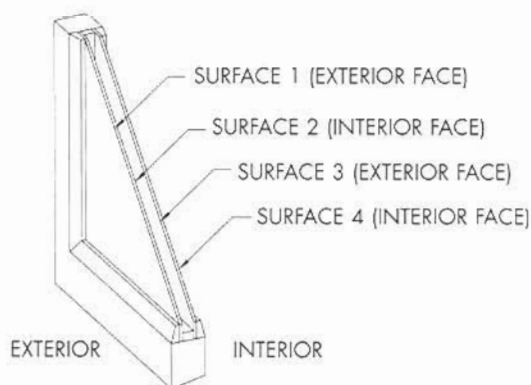

FIGURE 1

GLAZING NUMBERING SYSTEM

WINDOWS & DOORS

VOLUME 4 OF THE REHAB GUIDE

TABLE OF CONTENTS

FOREWORD **3**

1. INTRODUCTION **4**

2. EXISTING WINDOW & DOOR OVERVIEW **6**

3. GLAZING **14**

4. WINDOW FRAMES & REPLACEMENT UNITS **20**

5. STORM WINDOWS & SCREENS **26**

6. SKYLIGHTS **30**

7. DOORS & FRAMES **33**

8. CASING & TRIM **42**

9. HARDWARE **47**

10. FLASHING **51**

11. CAULKING, SEALANTS & WEATHERSTRIPPING **54**

12. SHUTTERS & AWNINGS **61**

APPENDIX: PROFESSIONAL ASSOCIATIONS & RESEARCH CENTERS **63**

Prepared for:

U.S. Department of Housing
and Urban Development
Office of Policy Development
and Research

Prepared by:

Steven Winter Associates, Inc.
Building Systems Consultants
Norwalk, CT

Contract DUI00C000005956

May 1999

CREDITS

STEVEN WINTER ASSOCIATES, INC. STAFF MEMBERS
WHO WERE INSTRUMENTAL IN THE DEVELOPMENT AND
PRODUCTION OF THIS GUIDEBOOK INCLUDE:

Steven Winter
Principal-in-charge

Alexander Grinnell
Project manager

Michael J. Crosbie, Ph.D., RA
Editor-in-chief

Masaki Furukawa
Chief illustrator

Paul Romano, William Bobenhausen
Project team members

U.S. DEPARTMENT OF HOUSING AND URBAN DEVELOPMENT
OFFICE OF POLICY DEVELOPMENT AND RESEARCH, AFFORDABLE
HOUSING RESEARCH AND TECHNOLOGY DIVISION

David Engel
Director

Nelson Carbonell
Senior architect

GUIDEBOOK DESIGN

Andrew P. Kner
Art Director

Michele L. Trombley
Assistant Art Director

Elizabeth Rosen
Symbols

There are three primary types of low-e coatings: high transmission low-e coatings are typically most appropriate for heating climates allowing the most solar heat to enter the building; selective low-e coatings are suitable where heating and cooling are required because they allow the greatest amount of daylight and moderate heat transmission; low transmission low-e coatings are suitable for cooling climates, allowing the least amount of heat to enter the building and reducing the amount of visible light transmission to control glare. The NFRC rating is the simplest means of assessing the performance of each type of coating, which is often not readily identified on the unit itself.

Within the same climate different low-e glazing materials may be desirable. In a cold climate, a home may use a window with a low SHGC on elevations other than south facing to preserve as much heat as possible where there is little opportunity for the sun's penetration, but may utilize a high SHGC at the south facade to benefit as much as possible from solar gains where exposed to the direct sunlight.

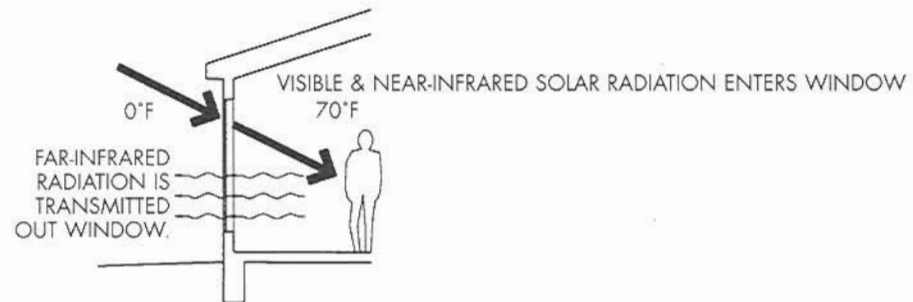

CLEAR GLASS ALLOWS SOLAR HEAT GAIN BUT DOES NOT REDUCE WINTER HEAT LOSS.

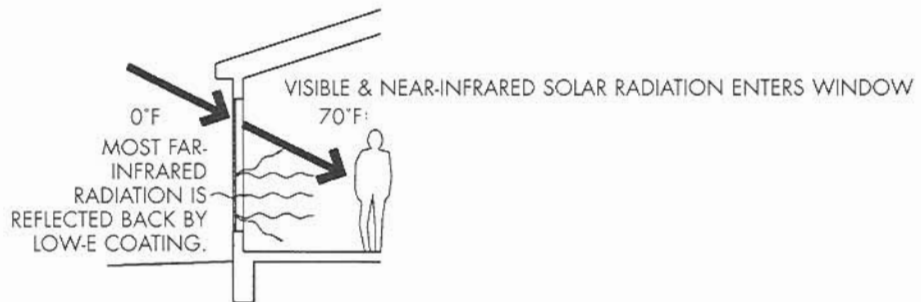

HIGH TRANSMISSION LOW-E GLASS PROVIDES SOLAR HEAT GAIN AND REDUCES WINTER HEAT LOSS.

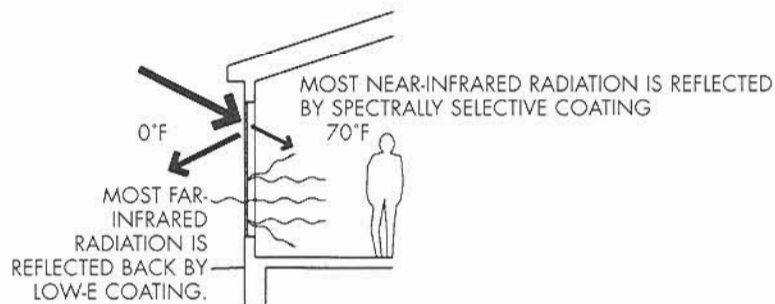

SELECTIVE TRANSMISSION LOW-E GLASS REDUCES WINTER HEAT LOSS AND SUMMER HEAT GAIN.

FIGURE 2

In addition to energy performance, glazing must also meet minimum code requirements for impact, wind, and fire resistance. The applicable codes vary by locality and should be referenced in the selection of new glazing for all types of fenestration. Numerous products and standards have been developed recently to address concerns such as high wind and theft resistance. These new products are made of acrylic and polycarbonate in corrugated and cellular forms to increase strength and insulation and reduce weight. Plastics, either by themselves or in combination with glass, improve impact resistance. New plastic materials have also been developed that provide increased fire resistance greater than glass but must be incorporated in an equally resistant frame.

Various specialty glazing products suitable for matching existing glazing materials, such as stained, textured, and salvaged glass, are available from sources identified in *Traditional Building* magazine and *Old House Journal*. An example of textured glass that is decorative and functional is prismatic glass. Prismatic glazing, characterized by a surface of textured small tile shapes assembled in a structural grid, projects light in a specific direction to illuminate areas deep in a space. Primarily used in commercial applications or street pavement lights, this material is also found in older homes. The material was employed in canopy applications appropriate for windows that are in close proximity to adjacent structures. However, the concentrating effect increases heat and glare. Prismatic glass is no longer manufactured due to the introduction of electricity and difficulty of cleaning, but can be obtained through salvage sources.

Glass block is enjoying a revival, and has the advantages of security, noise absorption, and light diffusion. The material is available with many of the same efficiency strategies as windows, employing reflective glass and fibrous inserts, with R-values equaling and exceeding some insulating glass. The mortar layers or frame material between units also serve as a shading device. Traditional glass block has been adapted for mortar-less application with the use of a rigid frame material and silicone sealants. This new generation of glass block has been adapted to provide up to 90-minute fire ratings. Available as an acrylic product, the reduced weight has significantly simplified the installation process (Fig. 3). This reduced weight also allows it to be installed as an interior partition without structural modification, and can be used in operable casement window units.

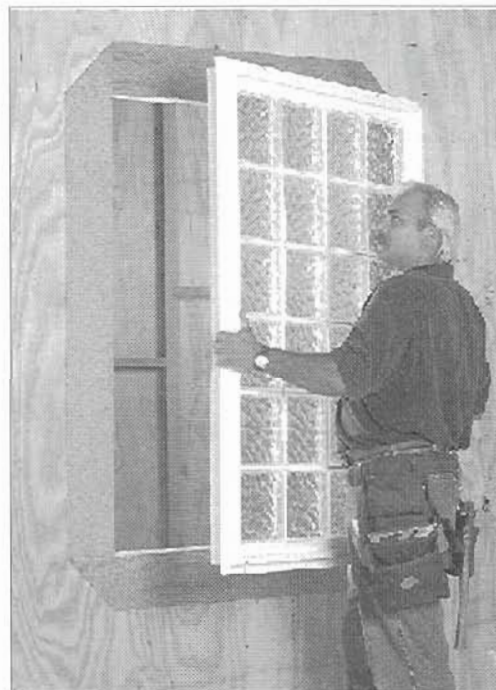

INSTALLATION OF ACRYLIC BLOCK WINDOW UNIT AS MANUFACTURED BY HI-LITE PRODUCTS, INC.

1. CLEAN AND POLISH EXISTING DAMAGED GLAZING.

Damage can occur from either physical abuse or caustic chemicals resulting in stains, etching, or discoloration. Physical abuse might include a branch brushing repeatedly against a window or impacts of airborne debris such as fine sand. Acid rain, alkyls from cleaning solutions, or exposure to water or rain runoff from concrete and masonry building materials are typical caustic assaults. Minimally damaged glazing often can be restored with a simple cleaning solution such as ammonia-based solution, xylene, toluene, or trisodium phosphate. Damaged glass not readily replaceable can be repaired by a mechanical polishing method with the use of compounds such as cerium oxide paste. In all instances the source of damage should be identified and corrected before rehabilitation.

ADVANTAGES: Preserves original, perhaps unavailable materials; may be most cost effective.

DISADVANTAGES: Often other components, such as sealants, have also deteriorated and favor total replacement. A high degree of skill and experience is required to properly polish glass.

2. APPLY TINTED OR REFLECTIVE FILM TO EXISTING WINDOW GLAZING.

Numerous film products are available from manufacturers such as 3M and Courtaulds to control the amount of daylight and solar gain transmitted through existing glazing. Tinted products can significantly reduce the full spectrum of light, reducing solar heat gain and glare. Reflective products selectively reduce portions of the light spectrum to either accept or reject heat and visible light. Each product is formulated for a specific climate and the selection of film and its specific application will determine the ultimate benefit. All of these products block the majority of UV rays to reduce fading of interior furnishings and provide limited protection from shattered glass.

ADVANTAGES: Application of film is a relatively simple, low-cost means of improving performance relative to replacement. Reduced heating and cooling loads not only provide operational savings and increased comfort but may permit smaller mechanical equipment. Appropriate films may eliminate the need for additional sun control devices, such as blinds and curtains, providing a uniform appearance to the exterior.

DISADVANTAGES: Retrofit film application will not equal the performance of factory applied materials nor will its exposed surface perform as well over time. Low-e coatings are subject to physical and caustic damage from cleaning with ammonia-based products. Replacement of the film is a difficult, labor-intensive process. Application of film to an insulated window unit may aggravate the expansion and contraction of one side of the glazing, increasing stress of the glass and seal. Reduction of transmitted light and heat may be offset by additional heating and lighting requirements if not carefully selected.

3. APPLY SAFETY FILM TO EXISTING WINDOW GLAZING.

All film materials provide limited resistance to shattering—some better than others. Safety film products are manufactured primarily for this purpose and may be combined with sun control properties. The increased resistance provided by these films, similar in principle to laminated glass, may reduce the risk of airborne glass and exposed shards upon impact. Films will provide resistance to accidental impact and storm debris. The resistance of the material is independent of the resistance provided by the window frame, but the preservation of the building envelope during a storm often will prevent costly water damage. The material may also prove to be a deterrent to vandalism and theft.

ADVANTAGES: Safety films may preserve the building envelope during storms. Safety films may provide a cost-effective means of increasing resistance of existing glazing. Areas subject to high winds may also benefit from films, which may preserve the building envelope in moderate storms. In addition to providing safety they may also provide comfort and savings associated with the reduction of sunlight and UV protection of furnishings.

DISADVANTAGES: All components of a building envelope must be of equal resistance in preventing either the entry of a storm or intruder. Safety glazing that is not secured in the frame itself will only maintain integrity with itself and not the window unit. Film will to some extent reduce visible light transmittance and may slightly obscure views.

4. INSTALL INSULATED GLASS INSERTS.

Existing single-layer glazing is replaced with new insulated units with the modification of the existing wood sash and a new track mechanism. Presently, only a Bi-Glass Systems licensed contractor performs this patented process on site in a mobile workshop (Fig. 4). The exterior face of the muntin is removed and the new unit is inserted with a siliconized latex sealant. A new muntin face is applied to match the existing or may be left as a flush surface to provide for easier maintenance. Historic metal windows with deep profiles often can readily accept insulated glazed units, but due to the poor thermally conductive properties of the frame do not provide significant performance gains and are ultimately very expensive relative to the benefit. The effect of heavier insulated units on operable windows should be considered.

ADVANTAGES: Provides improved performance while preserving the original appearance of the window. Replacement of glazing is an opportunity to choose from new technologies, such as low-e glass. The new track mechanism may also provide for ease of operation and cleaning with the addition of a tilt/turn feature. The relative ease of installation is achieved without disturbing surrounding materials and minimizing debris and use of new resources. Cost of such replacement may potentially be lower than replacement of the entire unit.

DISADVANTAGES: Bi-Glass system is presently not available nationwide and is only suitable for existing wood windows. Existing window frame and sash must be in good condition. The system will not correct for perimeter sash leakage, which may account for up to 40% of a home's air leakage.



EXISTING WINDOW MEASURED AND GLASS UNITS FABRICATED



EXISTING SASH REMOVED, CAVITIES INSULATED AND NEW TRACKS INSTALLED



WINDOW SASH IS REMOVED AND MODIFIED TO RECEIVE INSULATING GLASS UNIT, EXISTING MUNTINS APPLIED TO SURFACE



SASH IS INSTALLED WITH NEW HARDWARE PROVIDING FOR TILT-IN OPERATION

INSTALLATION OF INSULATED GLASS INSERT

FIGURE 4

5. REPLACE EXISTING GLAZING WITH BETTER PERFORMING GLAZING.

This method, although rarely used, provides the opportunity to employ new glazing materials in the repair of existing windows. Repair of windows preserves the original appearance and is often the most cost-effective strategy, as new glazing technologies may be employed for little additional cost. New technologies provide increased impact, fire, and thermal resistance and may be applied to previously unavailable curved glazing and decorative glass block.

ADVANTAGES: Particularly cost-effective when trying to address a single attribute such as impact resistance or glare.

DISADVANTAGES: Replacement of glazing itself may be compromised by the existing frame and sash materials. Cost of repair will vary dramatically depending on the region and should be part of a comprehensive repair effort.

FURTHER READING

Guide to Avoiding Glass Failure, Association of Industrial Metallizers Coaters and Laminators, November 1996.

"Low-E Glass - Why the Coating Is Where It Is," *Energy Design Update*, March 1990, pp.5-7.

"No Pane, No Gain (Window Technology: Part One)," *Popular Science*, June 1993, pp. 92-98.

Residential Windows, John Carmody, Stephen Selkowitz & Lisa Heschong, New York: W.W. Norton, 1996.

"Through the Glass Darkly," *Popular Science*, July 1993, pp. 80-87.

Twentieth Century Building Materials: History and Conservation, Thomas C. Jester, New York: McGraw-Hill, 1995.

PRODUCT INFORMATION

Bi-Glass Systems, Inc., 35 Braintree Hill Park, Suite 112, Braintree, MA 02184; 800-729-0742.

Cardinal IG, 12301 Whitewater Drive, Minnetonka, MN 54343; 612-935-1722 (glass manufacturer).

Co-Ex Corp., P.O. Box 326, 41 Hammer Mill Rd., Rocky Hill, CT 06067; 800-888-5364 (single and multiple walled polycarbonate).

Courtaulds Performance Films, P.O. Box 5068, Martinsville, VA 24115; 800-223-4385 (applied performance film products).

Hy-Lite Block Windows, 101 California Ave., Beaumont, CA 92223; 800-827-3691; www.hy-lite.com.

IBP Glass Block Grid System, Acme Brick, 2917 W. 7th St., Fort Worth, TX 76107; 800- 932-2263; www.ibpglassblock.com (aluminum frame glass block).

Libbey-Owens-Ford Co. Building Products, P.O. Box 799, 811 Madison Ave., Toledo, OH 43697; 419-247-4721 (glass manufacturer).

MSC Specialty Films Inc., 10801 75th Street North, Largo, FL 33777-1430; 800-282- 9031 (applied performance film products).

PPG Industries, Inc., One PPG Place, Pittsburgh, PA 15272; 412-434-3533 (glass manufacturer).

Southwall Technologies, 1029 Corporation Way, Palo Alto, CA; 800-365-8794 (applied performance film products).

3M, 3M Center 225-4S-08, P.O. Box 33225, St. Paul, MN 55133-3225; 800-480-1704 (applied performance film products).

Viracon, 800 Park Drive, P.O. Box 248, Owatonna, MN 55060; 507-451-9555 (laminated glass).

WINDOW FRAMES & REPLACEMENT UNITS

ESSENTIAL KNOWLEDGE

Wood has historically been the primary window sash and frame material due to ease of manufacture, availability, and good thermal performance. The major disadvantage of wood has been its need for regular maintenance. Ease of maintenance has spurred competing materials such as steel in the early half of the 20th century and, more recently, aluminum and vinyl, which have now surpassed wood in combined sales. Recent improvements in glazing technology have made the thermal performance of aluminum and vinyl frames and the method of assembly significant issues. New frame technology employs thermal breaks in metal materials and insulated cavities in vinyl frames. New materials are being developed with greater dimensional stability, some of which are less dependent on natural resources.

This new generation of materials—wood composite, fiberglass, and reinforced or reformulated vinyl (CPVC)—are stronger, more durable, and have insulative values equal to or higher than wood. The increased strength of frames also allows for narrower profiles, resulting in more glazing area relative to the size of the unit. A manufacturer of wood composite frames claims this may result in a 20% increase in the glazing area. These new materials are generally impervious to water and therefore will not swell or distort when exposed. New engineered wood materials, either composite or laminated, do not have a tendency to twist along the grain, like wood. The thermal expansion of materials such as fiberglass, composed primarily of glass fibers, closely corresponds to that of glazing material, reducing stress to seals and frame as the materials move in tandem, preserving infiltration performance. The increased dimensional stability and resistance of fiberglass, long used as a marine product, provides for consistent operation under varying climatic conditions and corrosive exposures. Fiberglass, unlike conventional vinyl material, is available in dark colors that are not subject to fading. The solid or wide extrusion profiles of either a high or low density cellular vinyl (CPVC) product provide a greater surface area for the chemical welding of corners, resulting in a stronger connection. Fiberglass—with strength similar to that of aluminum—is now used as reinforcement for windows and doors with wood veneer to achieve a traditional appearance.

New materials not only provide benefits relative to wood in terms of maintenance, but can surpass its thermal resistance by up to a factor of two. Low density cellular vinyl incorporates a large proportion of air, as does wood, and achieves comparable R-values. Engineered wood products have solid profiles with essentially the same value as conventional wood frames. Fiberglass and high-density cellular vinyl that have cavities filled with foam insulation, result in the highest R-value products available. These materials are not without their drawbacks, which may include higher production costs, increased weight, and UV degradation.

In addition to providing higher overall R-value for a window assembly, frames that minimize heat loss at the glazing edge are more resistant to condensation. A center-of-glass R-value for insulated or low-e glazing is typically significantly reduced adjacent to the frame. This is because in conventional windows, the spacer between glazing layers is highly conductive. Thus, condensation on residential windows often

first appears at the pane edge. New low conductivity (warm edge) spacers significantly reduce these losses, resulting in higher overall U-values. When selecting a window it is important to note the overall window U-value (which includes the frame) as indicated by the NFRC label. The window frame alone may account for up to a third of the window area; thus the selection of frame material is an important influence on the overall window performance.

The method of assembly is also an important consideration in overall window performance. Historically, glass was only available in small panes and a window frame joined several panes to form the desired opening. This grid of frame material is referred to as a muntin. As glass technology evolved, windows increased the size of the grid, ultimately only being restricted by the operable weight of the sash. With no structural requirement for muntins and the advent of insulating glass the grid was preserved solely for aesthetic reasons (sense of enclosure, ability to define expanse of view, existing architecture). Today there are several options available dependent upon the degree of authenticity desired relative to convenience or performance. A window sash with individual lites (panes) is inherently more expensive and less efficient because of the increased length of the glazing perimeter. These window muntins are described as true or authentic divided lites as they serve their original structural purpose. The width of these true muntins, however, is typically larger to accommodate the insulating glass. Multiple individually sealed glazing units also increase the likelihood of seam failure.

Alternate methods have been developed to simulate the appearance of true divided lites and provide the ease of cleaning a single pane and/or to minimize the cost of fabrication. Simulated divided lites are muntins (grilles) adhered to the surface of the glazing and often available with an optional air space grille (spacer bar) simulate the appearance of true divided lites at lower cost and without significantly compromising energy performance. Single-lite insulating glass reduces the likelihood of seam failure. Another type, referred to by some manufacturers as "snap in" grilles, can be removed for cleaning but are considered to be the least convincing because of their thin profiles. They are also subject to damage with repeated use. A third option offers a combined strategy: a true divided lite sash with a single full size panel, which is set into the sash like an integral storm unit. This provides a single surface to clean from the interior while maintaining a historically authentic appearance with good thermal performance.



FIGURE 1

MUNTIN TYPES

Wood window frames not properly protected are subject to swelling and rot. The repair of these windows is often possible. However, the source of the problem should first be identified and corrected. Otherwise window repairs may be temporary at best and could potentially ruin the window if it is adjusted to accommodate for these abnormal conditions. A swollen window that has been planed to accommodate swelling will provide an insufficient barrier to infiltration when the sash shrinks. Window sashes that have been fixed in place address infiltration but compromise ventilation and safety.

The benefits provided by new materials may be retained by the use of a variety of partial replacement methods (Fig. 2). The primary benefit of partial window replacement is the preservation of the original materials including surrounding trim and surfaces, which can save labor and material costs. The preserved material's potential useful life and ability to be replicated are often the driving criteria.

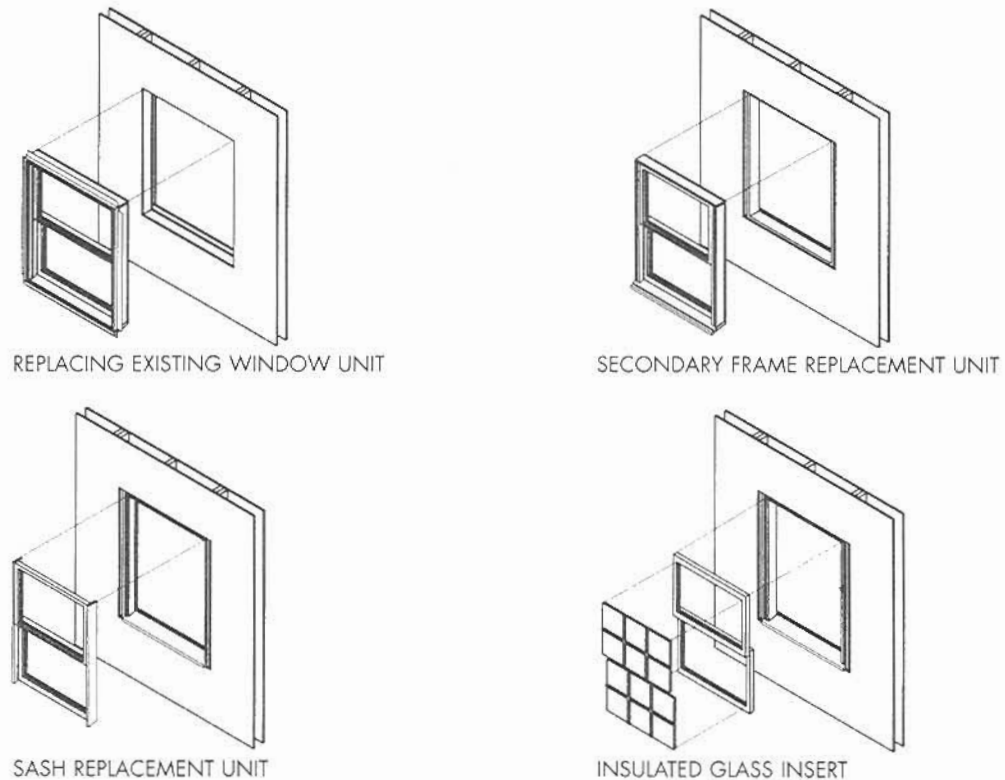

FIGURE 2

WINDOW REPLACEMENT UNIT TYPES

TECHNIQUES, MATERIALS, TOOLS

1. REPLACE EXISTING WINDOW UNITS.

Replacement of existing window units with an entirely new unit will provide the best available performance and the opportunity to assure proper installation of the unit. Sources of damage to the unit being replaced may be corrected with the removal of the original window.

ADVANTAGES: A new unit provides the longest useful lifespan and significantly improves thermal performance.

DISADVANTAGES: Usually the most costly alternative, with the existing window discarded as waste.

2. REPLACE EXISTING WINDOW SASH AND TRACK.

Replacement sash units are a very popular choice for partial window replacement (Fig. 3) and are now produced by the majority of window manufacturers, including Caradco, Marvin, and Weather Shield, among others. These inserts come in a kit, which includes the sash and track (jamb liners) with a counterbalance mechanism and hardware. The units are available in a wide variety of stock sizes or can be custom fabricated with a choice of glazing.

ADVANTAGES: Low degree of effort and skill required for installation. Adjacent surfaces and trim are preserved. Elements replaced are those subject to the greatest wear, preserving as many components as pos-

sible and thus reducing waste.

DISADVANTAGES: Existing wood frame must be in good condition with no rot and relatively square with parallel jambs. Partial replacement does not address air infiltration at the perimeter of the existing frame or causes of damage that may be found within the wall cavity.

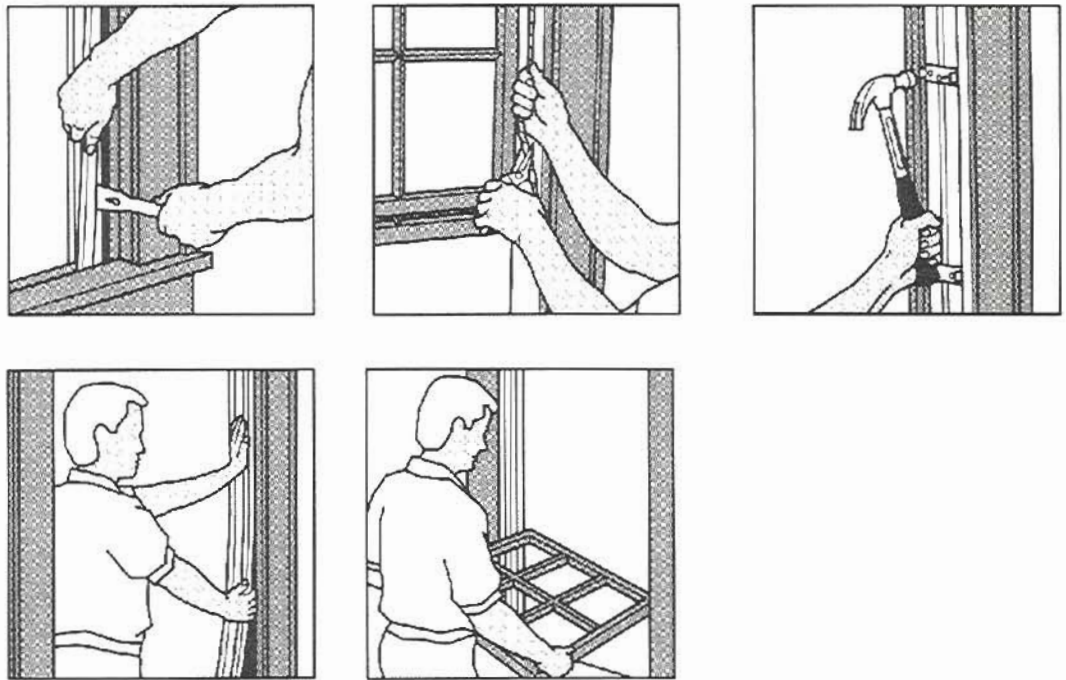

FIGURE 3

TYPICAL INSTALLATION OF A SASH REPLACEMENT WINDOW UNIT

3. INSTALL NEW (SECONDARY) WINDOW UNIT WITHIN EXISTING WINDOW FRAME.

The most popular form of replacement windows are vinyl units that fit within the existing window frame, although wood window units for this purpose are also available from Pella, and others. The secondary window unit is perceived as a unit within a unit, providing the sash and track with a pre-assembled narrow frame. These units are available in a wide variety of stock sizes or may be custom fabricated with a choice of glazing.

ADVANTAGES: The secondary frame is similar in concept to the replacement of sash and track in that only those parts subject to wear are replaced while providing benefits of new technology. The secondary frame may accommodate slightly out-of-square conditions.

DISADVANTAGES: Secondary frames reduce the amount of egress and glazing area, which may be in conflict with applicable building code egress requirements. As with other partial replacement methods, does not address air infiltration at the existing frame's perimeter.

4. INSTALL REPLACEMENT SILLS.

A wood window sill is often the most vulnerable component of a window frame because it is possible for standing water to accumulate on this surface and form rot. This common condition may ultimately compromise the entire wall assembly by providing the means of entry for water. Replacement sills have been developed expressly for this purpose. There are essentially two means of correcting this condition. The first is to use a sheet metal material as a cap over the existing seal to function as flashing. The second is a new generation of replacement sills made from such materials as wood composites and vinyl, as manu-

factured by Wenco, which are solid in profile and may be worked with conventional carpentry tools.
ADVANTAGES: A necessity for preserving the weather-tightness of the building envelope. The most economical means of addressing a common problem.
DISADVANTAGES: Both methods may serve to hide a more critical problem in which rot goes unaddressed and continues to erode surrounding materials. The metal flashing caps are considered unsightly by some and are subject to denting.

5. REPLACE EXISTING DAMAGED WOOD WITH EPOXY CONSOLIDANTS AND FILLERS.

Rotted or damaged wood frames can often be repaired with epoxy products. There are essentially two types of epoxy repairs: consolidants for use where the wood is intact; and a putty-like filler material for areas that are missing or require removal because they are beyond repair (Fig. 4). Epoxy consolidants will penetrate and bind with the wood fibers while preventing further deterioration. Consolidants, which are either poured or brushed on the surface in liquid form, bond with the wood fibers to create a surface with greater strength than wood and water resistant. The material cures in a matter of minutes or hours (depending on the amount used) and may then be worked as wood. Consolidants may be used as a primer for the application of an epoxy filler material, to fill voids or achieve intricate profiles that would otherwise be difficult and expensive to replicate in wood on a small scale. The increased strength of the epoxy material is suitable for structural elements such as an operable window frame when applied as per manufacturer's instructions. Consolidants are available from numerous sources (manufacturers and distributors) including Abatron, Conservation Services, Gougeon Bros. Inc., and Repair Care Systems USA, among others.

ADVANTAGES: Epoxy filler provides an alternative to solvent-based wood fillers, which may shrink as they cure or work themselves loose as materials expand and contract at different rates. Repair of existing wood members is often the most cost-effective solution with the least disruption. Epoxy can be worked like wood, maintaining the original appearance.

DISADVANTAGES: A degree of skill is required for proper application. The repair of damaged wood will not address the cause or progressive deterioration of adjacent materials.

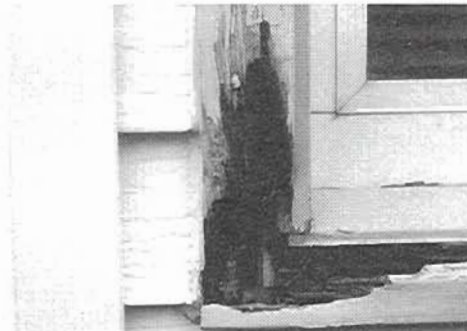

ROTTED WINDOW FRAME CLEANED



EPOXY FILLER APPLIED AND SANDED



EPOXY FILLER PAINTED

FIGURE 4

EPOXY FILLER

6. ADJUST WINDOW OR DOOR FRAME WITH SHIM SCREWS.

Shim screws, available from GRK Canada Ltd. and Resource Conservation Technology, Inc. are often an effective means of correcting an out-of-square condition. The screw functions as two different screws attached by a single length so as to allow sufficient anchorage while being able to fine tune the position of the frame without having to use shims.

ADVANTAGES: This method requires minimal effort to correct an out-of-square condition at minimal cost.

DISADVANTAGES: An out-of-square condition may be the result of a much more serious condition such as a rough opening which is too small to allow for the deflection of a header or an improperly sized or deteriorated structural member.

FURTHER READING

Repairing Old and Historic Windows: A Manual for Architects and Homeowners, New York Landmarks Conservancy, New York: John Wiley and Sons, 1992.

Residential Windows, John Carmody, Stephen Selkowitz & Lisa Heschong, New York: W.W. Norton, 1996.

Wood Preservation, Barry Richardson, 2nd Edition, Chapman to Hall, 1993.

Wood Protection Guidelines: Protecting Wood From Decay Fungi & Termites, Wood Protection Council National Institute of Building Science, 1993.

PRODUCT INFORMATION

Abatron, Inc., 5501 95th Ave, Kenosha, WI 53144; 800-445-1754 (wood repair products).

Alumax Building Products; P.O. Box 5350; Riverside, CA 92517; 800-626-3223 (vinyl replacement units).

Bird Vinyl Division, 1010 Withrow Court, Bardstown, KY 40004; 800-626-1524 (vinyl replacement units).

Caradco, P.O. Box 920, Rantoul, IL 61866; 217-893-4444 (wood sash only kits).

CertainTeed Corporation, P.O. Box 860, Valley Forge, PA 19482; 800-233-8990; www.certainteed.com (vinyl replacement units).

Chelsea Building Products, Customer Service, 565 Cedar Way, Oakmount, PA 15139; 412-826-8077 (vinyl replacement units).

Conservation Services, 8 Lakeside Trail, Kinnelon, NJ 07045; 201-838-6412 (wood repair products).

Easy Sills, P.O. Box 1454, Orem, UT 84059-1454; 801-785-4060 (retrofit vinyl window sills).

Gougeon Bros. Inc., P.O. Box 908, Bay City, MI 48707; 517-684-7286 (wood repair products).

Harvey Industries, 35 Commonwealth Avenue, Woburn, MA 01801; 800-882-8945 (vinyl replacement units).

Kolbe and Kolbe, 1323 S. Eleventh Avenue, Wausau, WI 54401-5998; 800-955-8177; www.kolbe-kolbe.com (wood sash only kits).

Marvin Windows, P.O. Box 100, Warroad, MN 56763; 800-346-5128; www.marvin.com (wood sash only kits).

Milgard Windows, 1010 54th Ave. E., Tacoma, WA 98424; 800-645-4273 (vinyl replacement units).

Pella Corporation, 102 Main Street, Pella, IA 50219; 800-847-3552; www.pella.com (wood replacement units).

Preservation Resource Group, Inc., P.O. Box 1768, Rockville, MD 20849-1768; 301-309-2222 (wood repair products).

Repair Care Systems USA, 300 Oak Street #155, Pembroke, MA 02359; 617-829-4555 (wood repair products).

Weather Shield Manufacturing, Inc., P.O. Box 309, Medford, WI 54451; 800-222-2995; www.weather-shield.com (wood sash only kits).

STORM WINDOWS & SCREENS

ESSENTIAL KNOWLEDGE

The storm window has traditionally been a product for cold climate regions, with small manufacturers providing custom unit sizes. Adding a storm window unit to an existing window provides several improvements. A storm window will dramatically reduce air infiltration and significantly increase the thermal performance of a single-pane window while reducing the impact of weather on the prime (original) unit. Available options such as low-e glazing will further reduce energy consumption while available tilt-in sash allows for ease of maintenance. High performance storm windows are also suitable for noise reduction.

The material of choice is aluminum, which provides high strength with a narrow profile. The poor conductive properties of aluminum may be mitigated by existing wood windows which serve as a thermal break. Conventional storm windows are typically not suitable for installation on vinyl prime units because the elevated temperatures between the units escalate the expansion and contraction of the frames. Storm windows may have a similar effect on windows joined with lead coming. Aluminum windows benefit from the addition of storm windows but the differential movement between the windows must be accommodated with material such as a double-sided adhesive cork tape.

Storm windows may be installed either on the interior or the exterior of the prime unit, and are typically available as sliding units operating vertically or horizontally, or as a fixed unit suitable for removal. Units are available in sizes large enough for sliding glass doors. Operable units available in double- and triple-track configurations provide for air circulation and self storage of a screen. Fixed units are suitable for picture windows. However, they require seasonal maintenance when used in conjunction with operable prime units.

The performance of a storm unit should be evaluated as a complete assembly. The design and material of the frame, its assembly, the installation, and (perhaps most importantly) the weatherstripping details all contribute to performance, which can vary dramatically even among models from the same manufacturer. An AAMA certified manufacturer or NFRC program participant should be able to provide the performance rating for the full product line.

Steel windows are particularly good candidates for storm windows to compensate for their high level of conductive heat loss. A storm unit will reduce transfer through the individual lites typical of a steel window sash. Storm windows may be applied to existing steel sash frame with fasteners, magnetic trim, or adhesive tape, or can be affixed to material adjacent to the steel frame.

Storm windows are commonly available with screen units. The traditional aluminum screening material provides strength but is subject to denting and corrosion. Fiberglass screening, significantly less expensive than aluminum, will not dent but can stretch. A screen's primary purpose is a barrier to insects, although some new screening materials have been developed that improve energy performance. Various fiberglass products are now available that reject unwanted heat gain in warm climates, but reduce ventilation and natural day-lighting (Fig. 1). The energy savings of such screening can be significant and some utilities subsidize their cost in hot climates. These screens are particularly effective on east and west elevations where the sun is at a low inclination, and passive solar control strategies such as awnings and overhangs are not generally effective. Fine aluminum louver shades can also reject the vast majority of the summer sun similar to Venetian blinds. Both products reject heat and damaging UV light before it reaches the prime window, thus protecting the window itself and reducing heat gains.

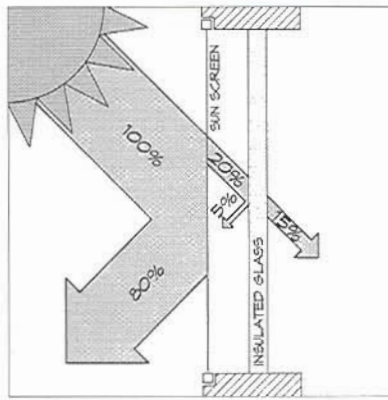

FIGURE 1

SOLAR SCREEN REFLECTION OF HEAT GAIN

On homes in coastal regions, copper, bronze, or stainless steel screening is a good choice because it resists corrosion better than aluminum. Such screening should not be combined with aluminum windows, as corrosive galvanic action may occur. Aluminum windows protected by paint or vinyl finishes are satisfactory for coastal regions.

TECHNIQUES, MATERIALS, TOOLS

1. INSTALL INTERIOR (FIXED/REMOVABLE) STORM WINDOWS.

Interior storm windows are typically secondary window units attached to the frame of an existing prime unit by a variety of means so as to provide for ease of removal (Fig. 2). With a storm window there are two separate frames, minimizing conductive transfer and air infiltration while preserving the exterior window appearance. Units are available either custom-fit or in do-it-yourself kit form, with a variety of glazing products. Acrylic glazing products are a popular choice for this application because they are lighter weight, easy to cut to size, and more damage resistant. Such units are available from national and regional



FIGURE 2

INSTALLATION OF AN INTERIOR STORM WINDOW UNIT AS MANUFACTURED BY THE ALTERNATE WINDOW COMPANY. UNIQUE SPRING TENSION FRAME COMPENSATES FOR MOST OUT-OF-SQUARE APPLICATIONS AND DOES NOT REQUIRE FULL PERIMETER TRACK.

manufacturers, including Allied Window, Alternative Window Company, Magnetite, Thermo-Press, Petit, and Window Saver Company, among others.

ADVANTAGES: Manufacturers claim a reduction in air infiltration of 75% or more and almost a 100% improvement in the R-value, frequently better than new prime units. The removable fixed unit is less costly than operable units and suitable for windows of all types without changing the appearance of the exterior. The addition of another glazing layer will reduce noise transmission, the likelihood of condensation, and will provide the opportunity to utilize improved glazing (such as low-e).

DISADVANTAGES: Interior storm units may promote condensation along the cold surface of the prime unit and in some instances cause damage to wood frames. These units are typically not operable and must be removed for ventilation. Acrylic products can discolor over time and cannot be cleaned with ammonia-based products.

2. INSTALL EXTERIOR (OPERABLE) STORM WINDOWS.

Exterior storm windows, in addition to providing a second unit, may also serve to protect the prime unit. Most new operable storm units employ several tracks, sashes, and screens that are self-storing. These units are significantly stronger and more costly because they must often serve the same functions as a primary unit. The criteria for selection of exterior storm windows are the same as for prime units. However, thermal conductivity is not a critical issue when attaching to a wood frame. Consideration should be given to elevated temperatures and humidity that might affect the prime unit. Storm windows are available from Allied Window, Harvey Industries, Keep In Touch Restoration Products, and Larson Mfg. Co., among others.

ADVANTAGES: Often provide the most cost-effective solution for poorly performing windows. Exterior storm units provide a barrier against weather and damage for existing prime windows.

DISADVANTAGES: Most units are visible from the exterior and create a flat appearance to windows. The addition of a storm unit will generally increase humidity and temperatures between units, which may damage either vinyl or wood window frames.

3. REPAIR OR REPLACE SCREEN MATERIAL.

New materials, such as fiberglass, are easier to install because of their flexibility and ease of cutting and resistance to denting, but may stretch or sag over time. Aluminum, the metal of choice, admits more light but is about twice as costly as fiberglass and can produce glare. Some aluminum products are painted gray or black to reduce glare. Other metals, such as bronze or copper, are suitable for corrosive environments but may not be used with common aluminum frames and are considerably more costly. These materials are commonly available through local building supply companies, or by mail from the McNichols Company, among others.

ADVANTAGES: The replacement of screens with the introduction of new materials allows for a simple repair.

DISADVANTAGES: Careful selection of material is necessary so as to assure compatibility with adjacent materials and environment.

4. INSTALL EXTERIOR SUN SCREENING DEVICES.

Exterior sun screening devices are effective in blocking the majority of sunlight before it reaches the prime unit, but may trap hot air between the two layers. Reduced daylight and visibility may not be significant in a cooling-dominated climate. The units require regular seasonal maintenance for optimum performance. These products are available in sunny climates throughout the nation from regional distributors. National manufacturers include Phifer Wire, among others.

ADVANTAGES: Sun shading screens quickly pay for themselves in homes with electric central air conditioning in warm climates. Unlike new spectrally selective glazing products, full spectrum may be recovered by removing the screen.

DISADVANTAGES: Shading devices obstruct views and daylight and require seasonal maintenance.

FURTHER READING

"What's The Difference - Door and Window Screening: Aluminum or Fiberglass?" Bruce Greenlaw, *Fine Homebuilding*, p.120, Sept. '95, No. 97.

PRODUCT INFORMATION

Allied Window, Inc., 2724 W. Mc Micken Avenue, Cincinnati, Ohio 45214; 800-445-5411 (interior and exterior storm windows).

Alternative Window Company, 15 Sherman Drive, Simsbury, CT 06070; 800-743-6207 (interior storm windows).

Harvey Industries Inc., One Moody Street, Waltham, MA 02154-5339; 800-882-8945.

Keep In Touch Restoration Products Group, 30 Lafayette Sq., Vernon, CT 06066; 800-569-9075.

Maclanburg-Duncan, 4041 North Santa Fe, Oklahoma City, OK 73118; 800-654-8454 (screen and storm window components and materials).

McNichols Company, P.O. Box 30300, Tampa, FL 33630-3300; 800-237-3820; www.permaglas-mesh.com (screen material).

Perma-Glas Mesh; P.O. Box 220, Dover, OH, 44622; 800-762-6694 (screen material).

Petit Industries Inc., P.O. Box 1156, Saco, ME 04072-1156; 207-283-1900.

Phifer Wire Products, Inc., P.O. Box 1700, Tuscaloosa, AL 35403-1700; 800-633-5955 (screen material).

Winstrom Architectural Products, 70 North St., P.O. Box 310, Park Forest, IL 60466; 312-748-8200.

ESSENTIAL KNOWLEDGE

Skylights brought light and ventilation into buildings before the advent of artificial lighting. Skylights have developed in tandem with windows and have become similarly sophisticated and high performing. Most glazing options available on windows today are also available on skylights. Long plagued by leaks, skylights now incorporate new flashing techniques to address virtually all variations of roofs, and numerous options have been developed for these increasingly popular units. Early skylight units also lacked effective means of shading. Shades and screens are now available in a wide variety from several manufacturers, including pleated and roller shades or aluminum slat blinds. These devices can also be operated remotely. Motorized skylights and shading devices may be controlled by a single device that can be programmed to respond to rain and temperature.

Older, mass produced skylights were typically made of a steel frame and wire glass. As artificial lighting and air conditioning became commonplace, these units have been neglected and/or painted over. As integral parts of the roofing system, however, they require regular maintenance. The conventional single layer of glazing is subject to condensation, which is collected by an integral gutter at the interior, and directed out through a weep hole. This hole, however, often becomes blocked or sealed, leading to what are perceived as leaks but what is, in fact, condensation. A well maintained skylight of this vintage, if regularly inspected, cleaned, and painted, will last many years. The thermal performance of these units, however, may be addressed by a strategy similar to storm windows to prevent heat from escaping in a chimney fashion. Most local iron shops can repair existing units with conventional methods.

New skylights may be employed in rehabilitation to provide light and ventilation in homes on small lots while providing privacy. The recent development of new skylights that are designed to fit between conventional framing spacing and around obstacles provides new opportunities to introduce lighting and ventilation without a significant amount of structural modification. There are essentially two types that do not require modification of framing: new narrow conventional units, and units generally described as tubular, (Fig. 1). Tubular skylights (also referred to as light tubes or pipes) concentrate light through a dome on the roof and direct it through a tube to a diffuser at ceiling height. These tubes do not have to be routed in a straight line, although it is preferable to efficiently distribute daylight.

Skylights can be compared by the NFRC rating system, and are rated with the units in a vertical application. Sloped applications reduce the thermal resistance of the unit by inducing convective loops. The NFRC is reevaluating skylight performance in sloped applications, given this concern.

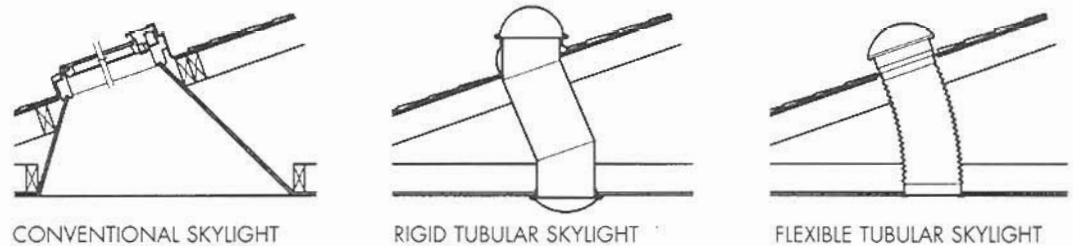

CONVENTIONAL SKYLIGHT

RIGID TUBULAR SKYLIGHT

FLEXIBLE TUBULAR SKYLIGHT

SKYLIGHT TYPES

FIGURE 1

TECHNIQUES, MATERIALS, TOOLS

1. REPAIR OR REPLACE EXISTING METAL SKYLIGHTS.

The repair of existing metal skylights is generally achieved by means of traditional metal work. Architectural metal fabricators and roofing contractors often can replicate or repair existing units. A few producers of traditional metal skylights still exist, including J.S. Wagner Company and Fisher Skylights.

ADVANTAGES: Skylights often play a significant role in defining architectural spaces within older buildings. A properly functioning skylight can provide effective ventilation and lighting during much of the year. Older units are capable of long service if properly maintained.

DISADVANTAGES: Original skylights are generally subject to high energy losses and condensation. They can also siphon heat in cold climates in a chimney effect. Roof openings should be minimized, as they are a source of call backs unassociated with workmanship.

2. REPLACE EXISTING SKYLIGHTS WITH NEW UNITS.

New skylight units have been designed to minimize labor associated with installation. Innovations include specially designed flashing materials and narrower units that do not require framing modification. The Wasco E-Class skylight requires no mastic or step flashing due to its continuous flexible flange, which provides a tighter seal against suction when subjected to high winds. The gasket attaches directly to the deck and eliminates the need for a curb, thus increasing daylight admitted. The integral vinyl curb provides good thermal conductive qualities and is resistant to decay caused by condensation. Narrower units available from Roto Frank of America fit within 16" and 24" on center framing spacing so that no structural modifications are necessary.

ADVANTAGES: New skylight products provide the opportunity to introduce ventilation and daylight in formerly inaccessible areas with minimal alteration.

DISADVANTAGES: Skylights in general are often the source of unwanted heat gain or loss, which is difficult to control. The shaft used to introduce light and ventilation to the conditioned spaces also increases the volume requiring conditioning and the amount of thermal stratification within the space, resulting in poor thermal performance relative to benefit.

3. INSTALL A TUBULAR SKYLIGHT.

Tubular skylights can be installed without modifying roof framing and can be configured around obstructions such as plumbing or ductwork. Some units are available with supplementary artificial light sources for use at night. These units are ideally suited for interior spaces, such as bathrooms, hallways, and closets. Flexible tubing is also available for ease of installation but is generally less effective at transmitting light. Available from several national manufacturers, including Solatube, Sun Light Systems, and Sun Tunnel among others.

ADVANTAGES: No structural modification required for installation. Light can be delivered to interior areas. Diffuser prevents conditioned air from traveling upward.

DISADVANTAGES: The value of this daylighting has yet to be confirmed as being a cost-effective replacement for artificial lighting, although the quality of daylight and the connection to the exterior it provides has intangible benefits. The uninsulated or poorly insulated tubes are subject to the formation of condensation. Acrylic domes and diffusers are also subject to discoloration over time.

FURTHER READING

Residential Windows, John Carmody, Stephen Selkowitz & Lisa Hescong, New York: W.W. Norton, 1996.

"Skylights: Daylights & Dollars," Sanford Wilk, *Roofer Magazine*, January 1997.

"Skylights: Design & Installation Basics," Donna Milner, *Journal of Light Construction* (New England Edition), May 1989, pp. 47-51.

"Skylights: The Design and Upkeep of Old Fashioned Rooftop Windows," J. Randall Cotton, *Old House Journal*, July/August 1992, pp.42-46.

"Skylight Options and Accessories," John Wagner, *Journal of Light Construction*, April 1996, pp. 47-50.

"Tubular Daylighting for Sun Lovers," Ted Rieger, *Home Energy*, January/February 1997, pp. 9-10.

PRODUCT INFORMATION

Andersen Windows, 100 Fourth Ave. North, Bayport, MN 55003-1096; 800-426 4261 (skylights).

Fisher Skylights, 50 Snake Hill Rd., West Nyack, NY 10994; 914-358-9000.

J.S. Wagner Company, Inc., 4909 46th Ave., Hyattsville, MD 20781; 301-927-9030.

Pella Corporation, 102 Main Street, Pella, IA 50219; 800-847-3552; www.pella.com (skylights).

Roto Frank of America, P.O. Box 599, Research Park, CT 06412; 800-243-0893; www.rotogroup.com (skylights).

Solatube, 5825 Avenida Encinas, Suite 101, Carlsbad, CA 92008; 800-773-7652.

The Sun Pipe Company, P. O. Box 2223, Northbrook, IL 60065; 800-844-4786.

Sun Light Systems, Inc., 21602 N. 2nd Ave., Suite B4, Phoenix, AZ 85027; 800-786- 7827; www.sun-stars Skylights.com.

Sun Tunnel, 2H Systems Incorporated, 5704 Clark Rd., Sarasota, FL 34233; 800-369-3664.

Velux-America, P.O. Box 5001, Greenwood, SC 29648; 800-283-2831 (skylights).

Wasco Products, Inc., P.O. Box 351, Sanford, Maine 04073; 800-388-0293 (skylights).

ESSENTIAL KNOWLEDGE

Door technology has evolved with window technology, making similar improvements. Thermal performance had long been unexamined because it was of little significance relative to the entire house envelope. Solid wood panel doors, although opaque, typically have an R-value equal to an insulated window, but appearance, durability, and infiltration remain the driving forces in selection. The technology of repairing existing doors has not evolved dramatically. A wood door is repaired as per traditional wood-working methods. Doors of materials such as steel and fiberglass can be repaired with proven methods practiced by other industries such as auto and marine repair.

The most cost-effective means of repair is often the replacement of damaged components. The difficulty of modifying doors favors replacement with a pre-hung unit. The benefits of a new or replacement unit include lower maintenance and durability. New materials and assemblies also provide the opportunity to increase comfort and security. A restored conventional solid wood panel door will not add comfort because of its poor thermal performance, and the panels may easily be breached to gain access. As discussed below, there are several options available to repair existing exterior doors, or to take advantage of new technologies in replacement units. Weatherstripping and security hardware are discussed in later sections.

The introduction of steel, fiberglass, and, most recently, carbon, has raised the standard for all doors. Manufacturers such as Marvin now produce doors with large areas of glazing, such as patio and French doors. There is a convergence of window and door technologies, where new materials or assemblies are used in each. Door security requirements and the dimensional stability of doors, however, mean that such materials as vinyl are typically used in combination with other materials. Fiberglass, which is equivalent in strength to aluminum, is now used by at least one manufacturer to produce structural rails and stiles that are then clad with wood veneer. Manufacturers are readily adopting multiple materials to improve performance. For example, at their perimeter, steel doors might use wood because it is easy to modify. Or steel might have a stainable vinyl film with wood-grain texture on top of its skin, laminated over a rigid foam core.

Manufacturers make an effort to simulate wood and traditional door styles with new materials and assemblies. Wood doors have also advanced technologically with such features as fiberboard cores, or finger-jointed stock to provide solid sections with dimensional stability. Such new assemblies, in combination with new protective finishes, have greatly improved durability and performance. Wood doors now also use rigid insulated cores of either expanded polystyrene or polyurethane. The majority of these cores is manufactured of polyurethane, which has an initial R-value almost twice that of expanded polystyrene. However, some manufacturing processes emit ozone-depleting CFCs and R-values deteriorate over time. The frames of steel exterior doors typically employ thermal breaks to reduce conduction and minimize condensation at the perimeter. NFRC U-factor ratings are a means of providing a comparable standard for evaluating the overall energy performance ratings among manufacturers participating in the NFRC Certification Program.

Exterior doors with large glazing areas have also improved performance. Developments in window technology have made this door type possible even in cold climates, as these doors utilize many of the same technologies used in high performance windows. However, fully glazed doors also require the security available in conventional doors. Manufacturers have begun to address these concerns with such

features as multi-point locking systems, reinforced frames and stiles, and new track designs.

There are essentially three types of doors suitable for replacement (other than an entirely new unit): a knock-down frame, a pre-hung insert, and a split jamb. Each offers ease of installation with the benefits of a new door. The determining factor is often whether these replacement units are available in the style of door desired. A knock-down door, also known as a prefit, is delivered as separate jamb and head pieces with attached casings that interlock. An insert door is pre-hung within its own frame and can be inserted into an existing door frame. The profile of the secondary frame (often of steel) is narrow; however, a door often has little width to spare, especially if the existing opening is out-of-square and requires shimming. A split-jamb door is pre-hung and available with attached trim. The door is inserted in the existing rough opening and joined along the length of the jamb at the stop. This method allows the preservation of the full door width but requires removal of the entire unit. Finally, a new door unit provides the greatest variety of options.

TECHNIQUES, MATERIALS, TOOLS

1. REPAIR EXISTING DOOR WITH TRADITIONAL MATERIALS.

The repair of existing doors may be achieved as would the repair of a window frame. See discussion of window frame repair and products.

ADVANTAGES: The most economical solution.

DISADVANTAGES: The end result of repair is often a poorly performing door. The proper repair of a door will generally require a high level of skill, which may be costly relative to the option of replacement, which will provide better performance.

2. REPLACE EXISTING DOOR WITH NEW DOOR SLAB.

The replacement of the door slab itself is possible if the frame is in good condition and square.

ADVANTAGES: Replacement of the slab will provide the opportunity to select from a wide variety of options. The replacement of slab and weather-stripping may address a lead hazard or be desirable to change the appearance.

DISADVANTAGES: A door is often only as good as its frame. This is particularly true for security and fire resistance. Entrance doors typically come pre-assembled with a frame at relatively little additional cost. The perimeter condition goes unexamined and installation of hardware and locks become complicated when adjusting for existing conditions. Weather-stripping, critical to ultimate performance, must be field applied.

3. REPLACE EXISTING DOOR WITH SECONDARY FRAME DOOR.

Steel frames, due to their inherent strength, permit thin jamb profiles, which minimize narrowing of the opening and provide the opportunity to use a steel door with higher insulative and security properties. The Benchmark Adjusta-Trim® product with integral trim is designed to encase the existing door frame and any associated lead paint (Fig. 1).

ADVANTAGES: A secondary frame allows simple installation and preservation of interior casings (Fig. 2). Replacement of the frame provides opportunity to improve the whole unit performance.

DISADVANTAGES: Reduces opening size, may not be allowed by code. Replacement requires sound condition of adjacent framing and secure attachment. This method will not improve perimeter infiltration or allow examination of existing conditions, which may also require rehab.

4. REPLACE EXISTING DOOR WITH A NEW PREHUNG DOOR.

Exterior doors are commonly available prehung, with ancillary components such as sidelights. A prehung door is no assurance that all the components have been manufactured or are warranted by the same manufacturer. It is important to determine specifically what components will be used in the assembly of the entire door unit.

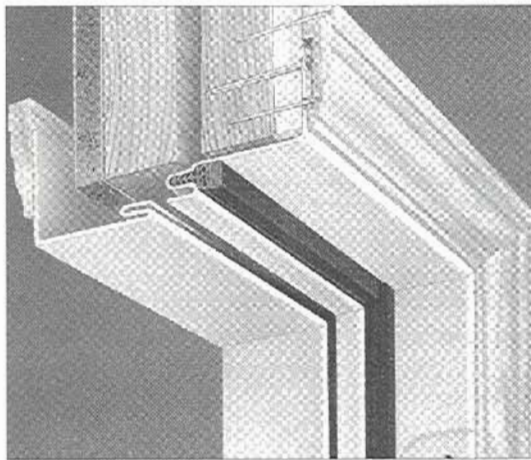

FIGURE 1

SPLIT-JAMB STEEL DOOR FRAME AVAILABLE WITH PRE-FORMED TRIM PROFILE OF FLUSH AS SHOWN. BENCHMARK® AS MANUFACTURED BY GENERAL PRODUCTS CO., INC.

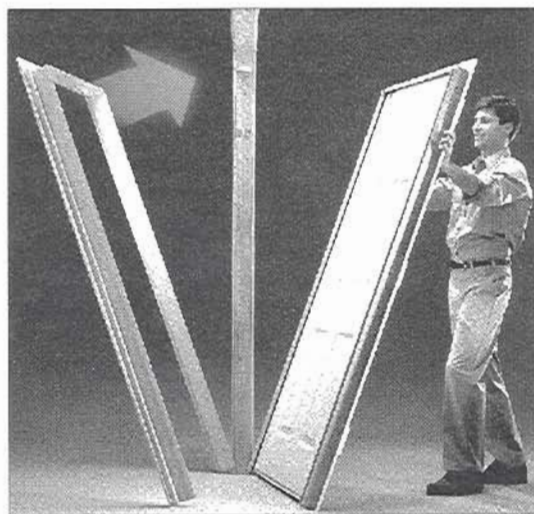

FIGURE 2

INSTALLATION OF A SPLIT-JAMB DOOR UNIT

ADVANTAGES: Replacement with a pre-hung unit provides the opportunity to assure that the existing conditions and all components are designed to provide optimum performance. This and convenience of installation is available for little to no additional cost when skilled labor is employed.

DISADVANTAGES: A prehung unit may use undesirable components not recommended by the manufacturer. Some new doors utilize construction methods, such as integrally glazed lites, that do not lend themselves readily to repair.

FURTHER READING

"Choosing a Front Door," Rich Ziegner, *Fine Homebuilding*, August/September 1994, pp.40-45.

"Door Prize," Christine Fishburn, *Remodeling Magazine*, December 1997, p.78.

"How to Fix Old Doors," Jonathan Poore, *The Old-House Journal*, June 1986, pp.222- 227.

"New Break-In Resistant Exterior Doors," Bill Phillips, *Today's Homeowner Magazine*, www.todayshomeowner.com.

"Ordering and Installing Prehung Doors," Steve Kearns, *Fine Homebuilding*, April/May 1992, pp. 62-65.

PRODUCT INFORMATION

Acadia Windows & Doors, 9611 Pulaski Park Drive, Baltimore, MD 21220; 800-638-6084 (vinyl doors).

Benchmark, General Products Company, Inc., P.O. Box 7387, Fredricksburg, VA 22404; 540-898-570 (pre-hung, knocked-down, split jamb, and replacement system steel doors and frames).

FrameSaver™, BMS, P.O. Box 631247, 1124 Bennet Clark Rd., Nacogdoches, TX 75963; 409-569-8211 (composite wood frame material).

GRK Canada Ltd., R.R. #1-1499 Rosslyn Rd., Thunder Bay, Ontario P7C 4T9; 800 263 0463 (fasteners).

Jeld-Wen (Challenge, IWP, Nord), 3303 Lakeport Blvd., Klamath Falls, OR 97601; 800-877-9482 (wood, steel, and fiberglass doors).

Morgan Manufacturing, 601 Oregon St., Oshkosh, WI 54903; 800-766-1992 (wood doors).

Peachtree Doors, Inc., 4350 Peachtree Industrial Blvd., Norcross, GA 30071; 404-497-2000; www.pease-doors.com (steel, fiberglass, and carbon doors).

Pease Industries, 7100 Dixie Highway, Fairfield, OH 45014-8001; 800-543-1180 (wood, steel, and fiberglass doors).

Simpson Door Co., P.O. Box 210, McCleary, WA 98557; 800-952-4057 (wood doors).

Stanley Door Systems, 1225 East Maple Road, Troy, MI 48083; 810-528-1400 (steel and fiberglass doors).

Therma-Tru Corp., P.O. Box 8780, Maumee, OH 43537; 800-537-8827 (steel and fiberglass doors).

Weather Shield Manufacturing, Inc., 1 Weather Shield Plaza, Medford, WI 54451; 715-748-2100 (steel and wood doors).

7.2

GARAGE AND BULKHEAD DOORS

ESSENTIAL KNOWLEDGE

Traditional garage doors, which either swung or slid open, have evolved into a unique door type now utilizing many of the same materials and assemblies found in entrance doors. Modern garage doors operate as a series of track-mounted panel sections or a single panel that pivots, with both stowed overhead. Improvements to these mechanisms have evolved to address safety and security. Sectional doors have been designed to prevent trapping one's fingers in the closing panels. Spring mechanisms have been redesigned to provide for easier tensioning and have an integral cable that prevents broken springs from taking flight. The failure of garage doors in high wind events exposes the building to a large breach, which can set off a chain reaction of envelope failures. Manufacturers have responded to these concerns with reinforced steel tracks and panel girders.

Of all the doors in a home, garage doors are perhaps the most vulnerable to security breaches due to their electronic control devices, which are subject to decryption by electronic scanners. New motorized door devices use a different code each time they operate to foil thieves. Because of their size and weight, automatic doors also pose a safety concern for children. Automatic door controls are required to have a reversing mechanism to detect objects in the door path.

Bulkhead doors, also referred to as basement doors, are a common feature (Fig. 3). Previously made of wood, which was subject to rot and abuse, bulkhead doors are available of steel, manufactured by Bilco and others. Such doors are subject to rust, as condensation often forms between cool basements and a warm exterior. Bulkhead doors of fiberglass with spring assisted hinges have recently been introduced to address these problems.



REMOVE OLD DOORS



INSTALL SILL



CHECK SQUARENESS



COMPLETE INSTALLATION

FIGURE 3

REPLACEMENT BULKHEAD DOORS

TECHNIQUES, MATERIALS, TOOLS

1. REPAIR EXISTING BULKHEAD OR GARAGE DOOR.

Conventional doors may be repaired by traditional methods as discussed in the window frame section. Any cause of damage should be corrected prior to repair or replacement.

ADVANTAGES: Typically the most economical solution, depending on the level of deterioration. Maintains the original appearance of the door.

DISADVANTAGES: Traditional materials such as wood and steel do not fare well in low slope applications such as bulkhead doors or where cold air from the basement causes condensation on the door surface.

2. REPLACE BULKHEAD OR GARAGE DOOR.

New door products offer greater convenience, security, and durability.

ADVANTAGES: New materials and hardware provide for lighter, stronger, and rot-resistant doors. These doors have improved functions and are available with storm-resistant construction and safety devices.

DISADVANTAGES: New materials are not available in all styles or sizes.

FURTHER READING

"Fiberglass Bulkhead Door," *Fine Homebuilding*

"Safer, More Secure Garage Doors," Jim Koscos, *Today's Homeowner Magazine*, <http://index.today-homeowner.com/todayarticles/door/11.95.16.html>.

PRODUCT INFORMATION

GARAGE DOORS

Clopay Corp., 312 Walnut St., Suite 1600, Cincinnati, OH 45202; 800-2CLOPAY; www.clopaydoor.com.

Designer Doors, Inc., 283 Troy Street, River Falls, WI 54002; 800-241-0525; www.designerdoors.com (traditional appearance doors).

General American Door Co. 5050 Baseline Rd., Montgomery, IL 60538; 800-323-0813.

Martin Door Manufacturing, P.O. Box 27437, Salt Lake City, UT 84127-0437; www.martindoor.com.

Overhead Door Corp., 6750 LBJ Fwy., Suite 1200, Dallas, TX 75240; 800-929-DOOR.

Raynor Garage Doors, 1101 E. River Rd., Dixon, IL 61021-0448; 800-4RA-YNOR; www.raynor.com.

Stanley Door Systems, 1225 E. Maple, Troy, MI 48083; 313-528-1400.

BULKHEAD DOORS

The Bilco Company, P.O. Box 1203, New Haven, CT 06505; 203-934-6363; www.bilco.com.

The Gordon Corp., 170 Spring St., Southington, CT 06489; 800-333-4564; www.gordoncellardoor.com.

Palmer River Products, Inc., 97 Common Road, Bristol, RI 02809; 401-254-0490.

7.3

STORM & SCREEN DOORS

ESSENTIAL KNOWLEDGE

A storm door is generally the most cost effective solution to a poorly performing primary entry door. The repetitive use and abuse of storm doors requires a product of sufficient strength and durability. Although available in wood and vinyl, storm doors made of aluminum or aluminum clad materials are popular for these reasons. An insulating air space between the storm door and the primary door off-sets the poor thermal quality of aluminum. The storm door also protects the primary door as a first barrier from weather. A storm door may trap moisture and heat within the intermediary space, which is detrimental to the primary door and weatherstripping. The finish and material of a primary door may not tolerate these elevated temperature conditions. Some primary door manufacturers require the use of a ventilated storm door to preserve their warranty. Combination storm doors incorporate a glass and screen panel that may be interchanged on a seasonal basis. Screen inserts are also available as an option for most storm door units (see Section 5 for discussion of screen materials). A new product, by the name of Hid-N-Screen, employs a conventional roll screen mechanism as a door where the door swing or obscured view is otherwise undesirable. Existing storm doors may also be repaired, depending on age and condition.

TECHNIQUES, MATERIALS, TOOLS

1. REPAIR EXISTING STORM DOOR UNIT.

Storm doors are typically subject to significant abuse in a home and correspondingly often require regular maintenance and/or repair. Fortunately, many components of a storm door are modular in nature and may simply be replaced with little effort. Common problems include malfunctioning latches and pneumatic closers, and broken screen or glazing panels (see respective glazing and screen sections for discussion of these materials). Common maintenance includes replacement of weatherstripping (see Section 11) and adjustment of latch and closer. The frame itself may be repaired as per methods described in Section 4.

ADVANTAGES: New units are very durable and resistant to abuse and the small effort required for maintenance or repair will achieve a long, useful lifespan.

DISADVANTAGES: An existing door that does not accommodate ventilation may contribute to primary door damage as well as increased thermal gains to the home in hot weather. Newer materials, such as vinyl and aluminum, are not subject to warping (unlike wood storm doors) and in humid or exposed areas should be considered.

2. REPLACE EXISTING STORM DOOR UNIT.

The traditional stock storm door has changed dramatically to provide greater durability with new materials as well as a wide variety of styles to match most homes. Storm doors can also provide some degree of resistance to forced entry.

ADVANTAGES: New storm doors provide a wide variety of options to suit most homes and can dramatically improve the energy performance of the primary door. New doors are now more durable than ever, requiring a minimum of repair and maintenance.

DISADVANTAGES: Careful selection of a door is required to assure it will perform well in relation to the primary door. Older homes might have custom built wood storm doors, which are costly to replicate with a degree of authenticity.

FURTHER READING

Screen Manufacturers Assn., 2850 South Ocean Blvd., #114, Palm Beach, FL 33480; 561-533-0991.

PRODUCT INFORMATION

Cole Sewell Corporation, 2288 University Avenue, St. Paul, MN 55114; 800-328-6596.

Gerkin Windows and Doors, P.O. Box 3203, Sioux City, IA 51102; 800-475-5061; www.gerkin.com.

Hid-N-Screen Inc., 131 Golden Days Drive, Casselberry, FL 32707; 407-810-9688; www.hidnscreen.com.

Installer's Choice™ Storm and Screen Doors, P.O. Box 853, Des Moines, Iowa 50304-0853; 800-777-3626.

Larson Manufacturing Company, Brookings, SD; 800-411-5277; www.larsondoors.com.

Maclanburg-Duncan, 4041 North Santa Fe, Oklahoma City, OK 73118; 800-654-8454 (screen and storm window components).

ESSENTIAL KNOWLEDGE

Interior doors help define spaces in a house, and provide visual and acoustical privacy. A door between a common space and a hall may have translucent glazing to allow light from perimeter rooms to penetrate interior spaces and also permit the return of conditioned air by means of an undercut door or transfer grille. Closet doors are typically opaque for visual screening, but louvers are desirable for air circulation.

Interior doors are often distinguished by their operation or function: sliding, pocket, by-pass, privacy, passage, or closet (Fig. 4). Interior doors do not have sills and rarely have thresholds, except where floor levels or materials change. Pocket doors are conventional door slabs that slide on a track and do not seal tightly. By-pass doors have a double track with a guide attached to the floor. Bi-fold doors operate on a top track.

Common interior door slabs are also distinguished by their method of construction: flush (either hollow or solid), panel, sash, and louvered. Hollow core flush panel doors are the most popular for interior applications. Their low cost is due to their ease of construction and engineered materials. The least expensive doors are composed of either particle board or jointed wood rail and stiles with a honeycomb core of cardboard and a hardboard skin material. Popular variations of panel doors include wood veneers and formed hardboard panels that simulate raised panel construction. These panels are available pre-finished with simulated wood grain. Hollow core doors are poor sound insulators, as the core air space functions like a soundboard. Solid core doors, using a variety of core materials, have better acoustical properties. Core materials are often particle board, solid jointed wood material (known as a stave core), or mineral cores.

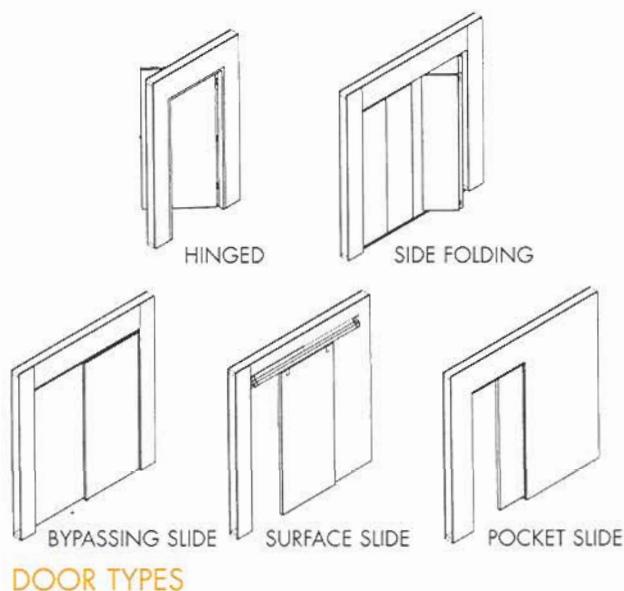

FIGURE 4

TECHNIQUES, MATERIALS, TOOLS

1. REPAIR EXISTING INTERIOR DOORS.

The repair of existing interior doors, almost exclusively constructed of wood, may be achieved by conventional methods as discussed in Section 4.

ADVANTAGES: Repairs of cosmetic blemishes may be made with minimal effort. Doors may be stripped of lead-based paints at time of repair to reduce potential contamination.

DISADVANTAGES: Repair of out-of-alignment doors, although typically utilizing traditional skills, may require a degree of sophistication.

2. REPLACE EXISTING INTERIOR DOORS.

Interior doors rarely require replacement but this may be desirable to redefine the relationship between rooms, by introducing either light, ventilation, or privacy. New prehung, secondary frame, and split-jamb doors require significantly less effort and skill than traditional door hanging methods.

ADVANTAGES: A change of interior doors may dramatically improve a space. New door materials such as engineered wood products and fiberglass are not as vulnerable to swelling and can prove more resistant to damage. A new unit will assure removal of a source of airborne lead contamination.

DISADVANTAGES: Doors in older homes were often custom fabricated and are difficult if not very costly to replicate. Door replacement requires disturbing existing trim, significantly increasing the degree of effort and can be a source of lead contamination.

FURTHER READING

"Open Door Policy - Troubleshooting Interior Doors," John Leeke, *Old House Journal*, January/February 1997, pp. 40-43.

"Silent Woods," William Borel, *Doors and Hardware*, August 1997, pp. 43-44.

PRODUCT INFORMATION

International Paper (Craftmaster), Masonite Division, Molded Product Group, One South Wacker Drive, Chicago, IL 60606; 800-446-1649; www.builderonline.com/~craftmaster.

Jeld-Wen, Inc. (Bend, Doorcraft, Elite, Klamath, Nord, Yakima,), P.O. Box 10266, Portland, OR 97210-9879; 800-877-9482.

Kaylien, P.O. Box 711599, Santee, CA 92072; 800-748-5627; www.kayliendoors.com (fiberglass interior).

Madawaska Doors, P. O. Box 938, Barry's Bay, Ontario, Canada, KOJ 1B0; 800-263-2358; www.madawaska-doors.com.

Morgan Manufacturing, 601 Oregon St., Oshkosh, WI 54903; 800-766-1992 (wood doors).

New Tech Doors, Phoenix Moulding & Door Supply (New-Tech Doors), 2682 Walnut Ave., Tustin, CA 92780; 800-622-0688.

ESSENTIAL KNOWLEDGE

Trim is used to conceal construction, to provide a finished appearance at gaps and joints between materials, and to accommodate slight variations between surfaces. Casing covers the gap between the window or door unit and the rough opening, and has traditionally been made of the same material as the frame, wood, and assembled on site. With the advent of new fenestration frame materials such as aluminum and vinyl, the difficulty of joining materials requires manufacturers to supply some form of casing as an integral part of the unit. The availability and economy of installing a new window or door unit with integral casing has made the use of exterior trim primarily decorative.

A window or door installation traditionally required several trim components (Fig. 1, 2). Sills and drip caps direct water away from the opening. Head casing, side casing, or aprons cover construction gaps. Components that extend the width of the frame are referred to as stools or jamb extensions. Standardized components have allowed manufacturers to provide units with either integral components or available options such as pre-assembled casing and jamb extensions. A double-hung window was traditionally trimmed different than a casement. With today's stock units exterior casing is not required and

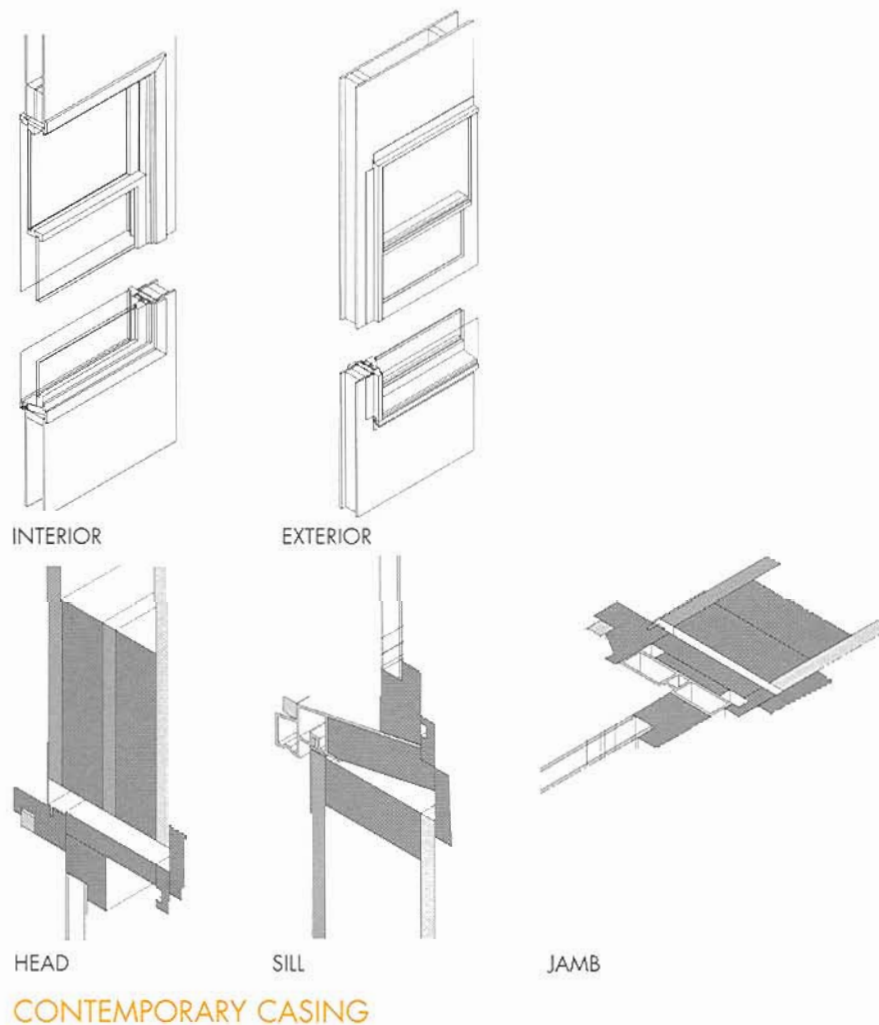

FIGURE 1

CONTEMPORARY CASING

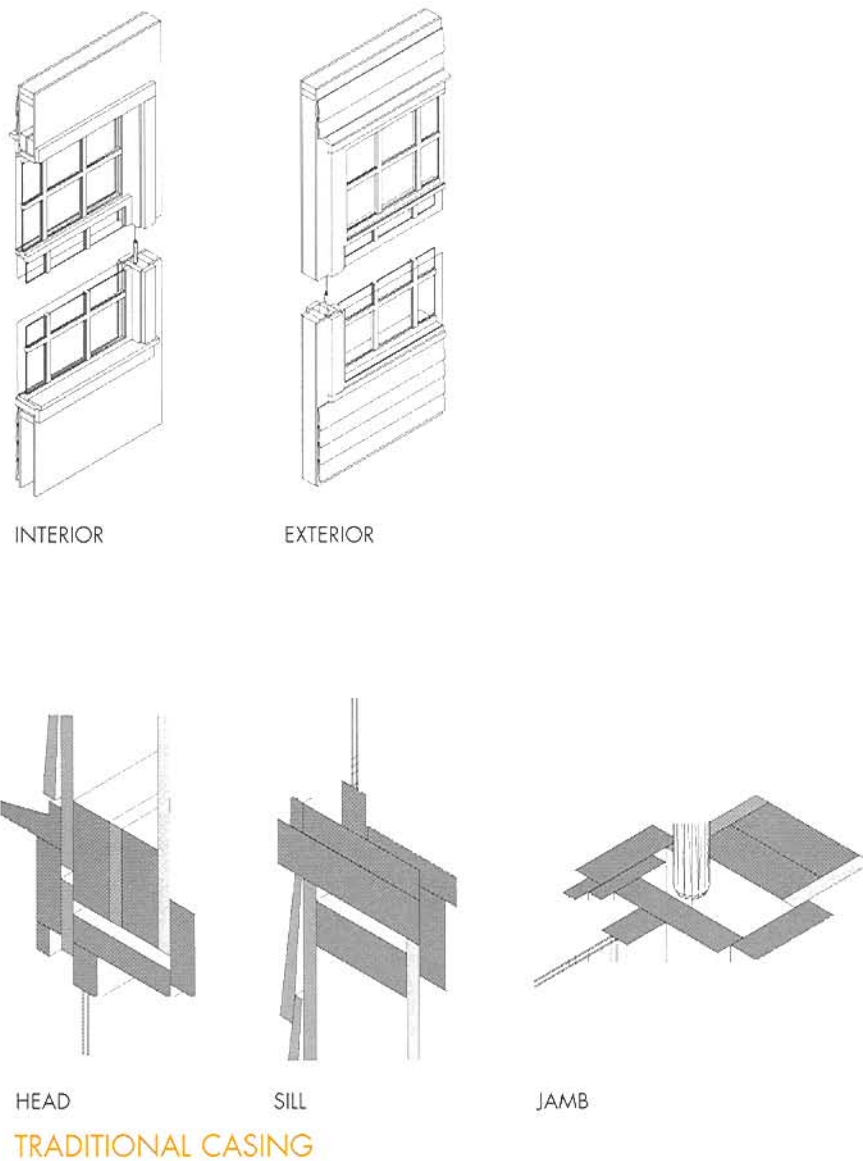

FIGURE 2 TRADITIONAL CASING

interior casing is typically uniform on all sides. Pre-hung doors are available with interior and exterior trim, including thresholds.

Wood trim may be repaired by means similar to those used for window and door frames (see Section 4 for further discussion). Diminishing natural resources and the escalating cost of wood, in combination with the lower cost of prefabricated products and the desire for low maintenance, have resulted in a wide variety of new replacement trim products for interior and exterior. Traditional fabrication of trim by small local millwork shops has evolved into standardized pre-fabricated, pre-finished products that utilize a variety of new materials—either recycled, engineered, or new plastic materials—with the appearance of wood but at lower cost and reduced maintenance, uniform qualities (dimensional stability), and ease of installation. The dimensional consistency of these new products allows less skilled workers to achieve the appearance of fine craftsmanship in areas such as miters and coping. New engineered wood exterior trim materials include finger jointed stock, laminated veneer lumber, hardboard, and fiber cement. All of these are modified wood products that are more durable, dimensionally stable, more flexible, and lower cost than premium solid wood species that are increasingly scarce.

Finger jointed stock is assembled from smaller, less desirable pieces of premium solid woods.

Laminated veneer lumber is composed of multiple layers similar to plywood products. Hardboard is made of sawdust pressed into uniform materials, some of which have properties similar to disease-resistant species such as cedar and redwood. Fiber cement, composed of a small percentage of wood fiber, is fire resistant and impervious to water and insects. All of these products are available in lengths up to 24', with uniform characteristics. These products are as little as a third of the cost of equivalent clear solid wood species. Trim for historic building styles, which is cost prohibitive to reproduce in wood, is now available from window manufacturers in new materials that easily accommodate a wide variety of shapes. Ornate carved patterns are now achieved with new molded wood formulations or new sophisticated tooling machinery that replicates original carvings. Wood veneered trim has become a cost-effective solution. Manufacturers of these new trim materials may also provide matching jambs, sashes, and frames to assure consistency of appearance.

Factory-finished products assure a durable, consistent finish achievable only under controlled conditions, and reduce on-site labor. Off-site finishing also removes flammable materials from the construction site. The traditional application of wood trim with finish nails has also changed. New materials utilize adhesives to weld plastic together on site or use interlocking screws to hide fasteners. Corner trim is now available preassembled and butt jointed. New application methods do not necessarily reduce cost, but may provide for greater consistency of workmanship and reduced installation time.

TECHNIQUES, MATERIALS, TOOLS

1. REPAIR EXISTING WOOD TRIM.

Existing trim should be assessed to determine the merit of repair versus replacement premised on the existing condition, availability of matching trim, and potential for contamination from lead-based paints. Before any work proceeds repair of existing causes of deterioration should be corrected. Almost any trim may be either repaired or replicated with the new epoxy and consolidant products but this is a labor intensive effort that may only be justified if the building is either historic or the amount of damage is limited.

ADVANTAGES: Repair of limited areas of damage may prove to be the most cost effective and least disruptive method while preserving the original appearance of the building. New wood repair products typically are more resistant to decay than wood.

DISADVANTAGES: Requires careful application of product and removal of existing damaged portions. Improper application may cause the filler to come loose over time if not properly bonded with sound material.

2. INSTALL SOLID/ENGINEERED WOOD TRIM.

Traditional solid wood trim and new engineered products are popular forms of trim because they lend themselves easily to modification during installation. Trim that is to be stained or otherwise left visible typically still requires solid virgin material, but recent innovations such as veneer applied trim provide for more uniform dimensional properties. Both commonly represent the most expensive option for trim material. Wood trim is also available pre-finished on all four sides, which frequently represents significant labor savings. Trim to be painted provides the opportunity to select from numerous new engineered wood materials, which are less costly. These new materials, in addition to being dimensionally more uniform, are available in longer lengths than traditional trimboards and are free of imperfections.

ADVANTAGES: May be readily modified at the time of installation and typically provide some form of labor savings attributable to more consistent quality of factory finish.

DISADVANTAGES: Engineered products may be more costly to achieve the same appearance, dependent upon value of labor savings. Prefinished materials may prove difficult to match at the time of installation. Some new materials do not have long performance track record.

3. INSTALL FIBER CEMENT/PLASTIC/POLYMER TRIM.

These materials are often only limited in length by transportation means. Longer lengths require fewer joints and associated labor, and the consistent profiles allow for ease of assembly. These materials are typ-

ically impervious to moisture and will not warp, twist, or degrade over time as readily as solid wood. The materials are often backed by exceptionally long warranties of up to 50 years. Some of these materials are formed into complex shapes and profiles and/or are flexible to accommodate irregular shapes and surfaces. Polymer trim, which has a lower density than the other materials, can be used to replicate existing ornate trim. These materials are affordable and are popular choices for replicating historical elements. Products such as Perma-Trim are designed with thin profiles specifically to encase or clad existing trim materials.

ADVANTAGES: Will reduce installation labor and maintenance costs. Materials are moisture and insect resistant and may be painted. Some products are manufactured with either waste or recycled content.

DISADVANTAGES: These materials are typically more costly than traditional materials and the selection of sizes and shapes is limited. They are generally not able to be modified.

4. INSTALL MODULAR/PREASSEMBLED TRIM.

The most difficult element of trim is its installation. Several new products have been developed to simplify the means of joining lengths of trim with a simple butt joint, yet preserving the appearance of either a mitered or coped corner. These new products have prefabricated corners or built-up elements that snap together or are adhered in place, hiding the means of attachment. Modular units allow for low skilled labor to replicate the appearance of craftsmanship from another era.

ADVANTAGES: Higher skill levels are not required for assembly. Typically require no finishing and are complete after installation.

DISADVANTAGES: The variety of products is limited and their cost is significantly higher than ordinary trim materials. Do not accommodate irregular conditions, such as out-of-square openings, and there is no means to modify the product for such conditions.

FURTHER READING

"Alternatives to Solid Wood Exterior Trim," Paul Fissette, Building Materials and Wood Technology Program, University of Massachusetts at Amherst; www.umass.edu/bmatwt/index.html.

The Secretary of the Interior's Standards for Rehabilitation and Guidelines for Rehabilitating Historic Buildings, Washington: U.S. Dept. of the Interior, National Park Service Preservation Assistance Division, 1990.

PRODUCT INFORMATION

WOOD RESTORATION

Abatron, Inc., 5501 95th Avenue, Kenosha, WI 53144; 800-445-1754.

Conservation Services, 8 Lakeside Trail, Kinnelon, NJ 07045; 201-838-6412.

Gougeon Bros. Inc., P.O. Box 908, Bay City, MI 48707; 517-684-7286.

Repair Care Systems USA, 300 Oak Street #155, Pembroke, MA 02359; 617-829-4555.

ENGINEERED WOOD TRIM

Durawood PE, The Eaglebrook Companies, 2600 W. Roosevelt Rd., Chicago, IL; 312-491-2500.

FrameSaver™, BMS, P.O. Box 631247, 1124 Bennet Clark Road, Nacogdoches, TX 75963; 409-569-8211.

Forestrim™, Forestex, P.O. Box 68, Forest Grove, OR 97116; 503-357-2131.

Prime Trim™, Georgia Pacific Corp., 133 Peachtree St., NE, Atlanta, GA 30303; 404- 652-4000.

Protrim™, ABT Co., 10115 Kencei Ave., Suite 150, Halessville, NC 28078; 800-927-3146; www.altco.com/trim.htm.

SmartStart™, Louisiana-Pacific Corp., 1 East First St., Duluth, MN 55802; 800-643-6893; www.lpcorp.com.

South Coast Lumber Co., 815 Railroad Ave., P.O. Box 670, Brookings, OR 97415; 541-469-4177.

FIBER CEMENT TRIM

Cem-Trim™, FLP Inc., Excelsior Industrial Park, P.O. Box 99, Blandon, PA 19510-0099; 888-327-0723; www.flpinc.com.

Harditrim™, James Hardie Building Products, 26300 Los Alameda, Suite 250, Mission Viejo, CA 92691; 888-J-HARDIE; www.jameshardie.com.

Maxitrim™, Maxilite, Inc., 17141 S. Kingview Avenue, Lason, CA 90746; 310-217-0316; www.maxitile.com.

Temple Inland Forest Products, P.O. Box N, Biboll, TX 75941; 800-231-6060; www.temple.com.

POLYMER TRIM

The Crowning Touch Inc., 8902 Rosehill Rd., Lenexa, KS 66215; 800-444-0462.

Flex Trim Industries Inc., P.O. Box 4227, Rancho Cucamonga, CA 91730; 800-356-9060.

Focal Point Architectural Products, P.O. Box 93327, Atlanta, GA 30377-0327; 800-662-5550.

Fypon Molded Millwork, 22 West Pennsylvania Ave., Stewartstown, PA 17363; 800-537-5349.

Ornamental Mouldings, 1907 Nuggett Road, P.O. Box 4257, High Point, NC 27263; 800-779-1135.

Zago Manufacturing Co., Inc., 240 M.L. King Blvd., Newark, NJ 07102; 973-643-6700.

PLASTIC TRIM

ABTCO, Abitibi Building Products, 3250 West Big Beaver Road, Troy, MI 48084.

Duraflex, Resinart Corp., 1625 Placentia Ave., Costa Mesa, CA 92627; 714-642-3665 (flexible trim products).

Easy Sills, P.O. Box 1454, Orem, UT 84059-1454; 801-785-4060 (retrofit vinyl window sills).

The James Wood Company, Box 3547, 2916 Reach Rd., Williamsport, PA 17701; 717-326-3662.

Outwater Plastic Industries, 52 Passaic Street, P.O. Box 347, Wood Ridge, NJ 07075; 800-835-4400; www.outwater.com.

Perma-Trim, Benjamin Obdyke Inc., 65 Steamboat Drive, Warminster, PA 18974; 800-346-7655; www.obdyke.com (vinyl trim cladding material).

ESSENTIAL KNOWLEDGE

Hardware is often used to describe the operation of doors and windows. For example, a door slab may be either a swinging, sliding, or pocket door (depending on how the hardware operates) and either passage, privacy, or entrance (depending on the locking mechanism). Often the greatest difficulty in the repair or replacement of hardware is identifying a source of suitable components. Several large distributors and services now exist that provide exhaustive catalogs with hardware very close in appearance and function to the original, if not an exact match.

New hardware has been developed to ease the installation of new preassembled fenestration products, such as pre-hung and pre-bored doors. Installation formerly performed in the field to assure proper alignment now can be performed by the supplier, who assembles the entire unit in the shop to be installed as a modular unit. The options for repair are most often replacement. New products and tools are designed to require minimal carpentry skills.

Fenestration hardware can be classified in three primary groups: hinges, tracks, guides, or a closer device for the purpose of determining movement; lockset, stop, or catch as a means of securing operable parts; and door knobs, lever handles, pull handles, or push plates as operating mechanisms. Other items to supplement these include thresholds and weatherstripping, discussed in Section 11. Most common residential hinges are a variation of the butt hinge—two plates or “leaves” secured to opposing sides that pivot around a pin connection created by alternating knuckles forming a barrel. Hinges may be mounted either on the surface, with their leaves concealed and only the barrel exposed, or entirely concealed (Fig. 1). Doors described as gliding, sliding, bypass, or pocket employ some form of a track or guide mechanism. The track or guide directs the movement of a series of rollers that are either top or bottom mounted. Guides are typically used where infiltration is not an issue, such as closet doors. Tracks provide a continuous barrier that can be weatherstripped, such as for a sliding patio door. Windows such as gliders also employ tracks with rollers for horizontal operation or double-hung windows use tracks with a friction fit. Closers are hydraulic (liquid filled) or pneumatic (gas filled) mechanisms that regulate the closing speed of a door. Closers can be adjusted to allow time to travel through a doorway while reducing the impact load of a heavy door on the frame. Spring hinges are generally a less costly means of assuring closure but cannot be regulated for speed or force. Windows and doors use such counterbalances as springs, weights, and screw devices for ease of operation. Other means of controlling the swing radius of a door or sash include either wall, floor, or hinge-mounted bumpers that resist the force or hold the door in an open position.

The simplest means of securing a door or window is a catch. Magnets, friction, and spring-tension devices provide just enough resistance so as not to release the unit. Safety latches can prevent access by children to hazardous areas and typically require a combination of actions to open. Interlocking

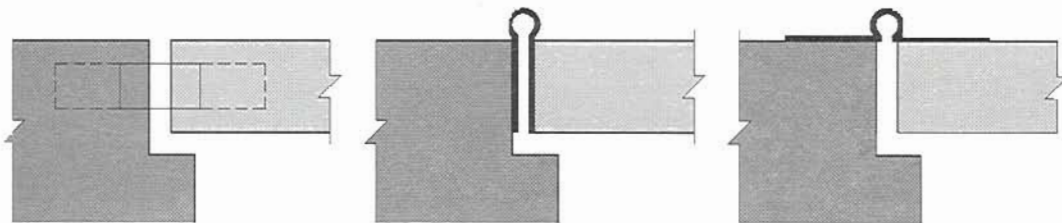

FIGURE 1

INVISIBLE, CONCEALED, AND EXPOSED HINGES

catches provide a degree of security and a tight seal (tension). Windows may use latches in combination with sliding rods or crank mechanisms to regulate openings. Crank mechanisms have been the subject of such improvements as automated remote windows and skylights, or scissor-like hinge mechanisms to accommodate heavier sashes. Guards secure fenestration while providing a view to the exterior. Guards are simple devices that limit the swing of a door when it is open with a chain or hinged bar on the strike side that is detachable when closed.

Locksets are commonly used on doors. Three common lock types are surface mounted (or rim lock), mortised units, and bored units (Fig. 2). Surface or rim locks are most often associated with deadbolts and deploy a bolt through an independent strike with a lock cylinder. Increased security is provided by longer bolts that are not spring activated. Mortised locks have been considered to be more durable but difficult to install in wood doors, and are typically found in older houses. Bored locks are inserted through holes bored in the door slab and can be described as either cylindrical, tubular, or interconnected. Tubular locks, the most common, prevent the knob from turning when locked. Interconnected locks use two mechanisms operated with a single key or with use of a single knob. All locks deploy one or more bolts that secure the operable door panel to a fixed surface (strike plate). The bolts are described as either spring latch (deploy in one direction without action, but more vulnerable to tampering) or dead-bolt (requires action from both sides).

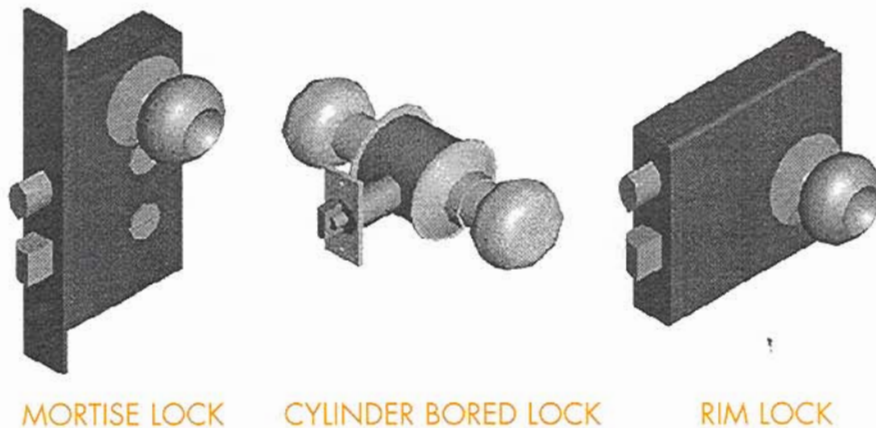

FIGURE 2

Hardware for door and window operation includes knobs and pulls (Fig. 3). Handles that lay flush are composed of bails and escutcheon plates. Operating hardware in combination with latches or locks can be either passage, privacy, or entrance. Passage devices provide access by means of releasing a spring loaded latch. Privacy devices commonly used on bathroom and bedroom doors have a thumb turn to restrict operation from the exterior. Entrance locks preserve security, with the operating hardware usually an integral part of the mechanism.

Hardware exposed to either climatic or harsh conditions is usually of non-ferrous metals such as brass, bronze, stainless steel, aluminum, or plated steel. Recently new materials have been developed that provide similar qualities but are less expensive or easier to form into complex shapes.

Hardware selection should consider ease of operation, installation requirements, durability, aesthetics, and security. For example, the selection of a hinge should take into account the following: frame and sash material of the door or window; number required; mounting method; the size, thickness, and weight of the door or window; clearance of hinge to avoid casing; frequency of use; the threat of intrusion; and applicable building codes. If a change is made to the original hardware there are other code issues that may apply, such as accessibility standards, fire codes, and egress requirements. *The National Fire Protection Association (NFPA) Standard for Fire Doors and Fire Windows NFPA 80* provides a useful guide for the selection of rated and non-rated doors and is often required by manufacturers for compliance with

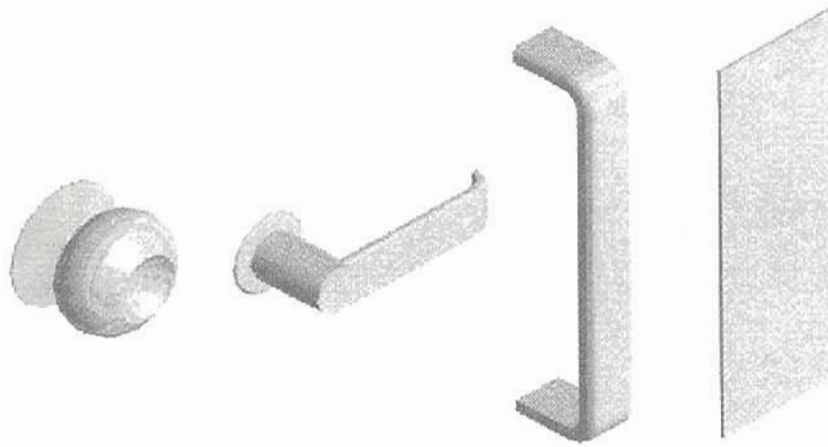

FIGURE 3

DOOR KNOB, LEVER HANDLE, PULL HANDLE, PUSH PLATE

their warranties. Locks may be in accordance with an ANSI standard that uses such criteria as resistance to forced entry and picking. There are three security grades: Grade 1 (high security), Grade 2 (light commercial and exterior home entrances), and Grade 3 (interior applications such as bedrooms or bathrooms). Accessibility regulations govern the design and construction of multi-family residential buildings but not single family private residences. ANSI A117.1 is the most common standard for accessibility requirements (including the Accessibility Guidelines of the Fair Housing Act), establishing minimum requirements for the location of hardware and ease of operation. Manufacturers now typically label products for compliance with the ANSI standard. There are numerous products that have been developed for retrofitting existing homes for accessibility (see Further Reading).

TECHNIQUES, MATERIALS, TOOLS

1. REPAIR/REPLACE EXISTING HARDWARE WITH ORIGINAL COMPONENTS.

The repair of existing hardware components is often difficult at best, requiring specialized skills. Hardware is subject to repeated stress and components that fail or have become worn should be replaced with materials of similar or equal strength. Few, if any, replacement parts are readily available.

ADVANTAGES: The primary advantage to repair is the ability to preserve existing appearance.

DISADVANTAGES: The effort and cost associated with repair may easily exceed the cost of a complete replacement unit.

2. REPLACE EXISTING HARDWARE WITH NEW UNITS.

Hardware is often a complex mechanical apparatus, subject to both fatigue and wear. The replacement of the entire unit, available in many variations, assures all parts will have similar life-span. New materials, such as high-density polyethylene washers, provide for years of operation without the necessity for regular maintenance. Reproduction and salvaged hardware is available from national distributors who specialize in historic hardware. These distributors will often provide assistance in matching existing hardware with salvaged or new materials.

ADVANTAGES: Often the lowest cost alternative, with materials widely available.

DISADVANTAGES: No precise match may be available for existing hardware to match other components of a door or window.

FURTHER READING

"Installing Locksets," Gary M. Katz, *Fine Homebuilding*, February/March 1993, pp. 40-45.

"Locks & Alarms: Old House Security," David Swearingen, *The Old-House Journal*, December 1986, pp. 472-475.

"Natural Selection," Timothy Taylor and Michael J. Crosbie, *Doors and Hardware*, March 1997, pp. 45-53.

"Upgrading Door Locks and Deadbolts," Dan Bowers, <http://index.todayshomeowner.com/todayarticles/door/06.95.30.html>.

NFPA 80-1990, Standard for fire doors and windows, National Fire Protection Association, Quincy, MA.

PRODUCT INFORMATION

Ball and Ball Hardware Reproductions, 463 W. Lincoln Highway, Exton, PA 19341; 800-257-3711.

Barry Supply Co., 36 West 17th Street, New York, NY 10011; 212 242 5200 (window replacement hardware).

Blaine Window Hardware, Inc., 17319 Blaine Dr., Hagerstown, MD 21740; 800-678-1919.

Cirecast, 380 7th Street, San Francisco, CA 94103; 415-863-8319.

Custom Service Supply Corporation, 1801 NE 51st Street, Pompano Beach, FL 33064; 800-933-3888; www.customservice.com.

Crown City Hardware Co., 1047 N. Allen Ave., Pasadena, CA 91104.

Dawson's Supply, Inc.; www.dawsonsupply.com.

Guardex High Security Strike, Master Lock Co., 300 Webster Road, Auburn, AL 36830; 205-826-3300.

GRK Canada Ltd., R.R. #1-1499 Rossllyn Rd., Thunder Bay, Ontario, P7C 4T9; 800-263-0463.

G-U Hardware, Inc., 11761 Rock Landing Drive, Suite M-6, Newport News, VA 23606-4235.

Knappe & Voght Mfg. Co., 2700 Oak Industrial Drive, Grand Rapids, MI, 49505; 800-253-1561; www.kv.com.

Kwikset Corporation, 516 East Santa Ana Street, Anaheim, CA 92803-4250; 714 535 8111.

L.E. Johnson Products, Inc., 2100 Streling Avenue, Elkhart, IN 46516; 800-837-5664.

Newman Tonks, P.O. Box 548, Shepardsville, KY, 40165; 800-826-5792; www.neuman-tonks.com.

Piersons, P.O. Box 663, Edgemont, PA 19028; 800-446-9111; www.piersons.com (hardware supplier with search service).

Pullman Mfg. Corp., 77 Commerce Dr., Rochester, NY 14623; 716-359-1350 (spring counterbalances).

Resource Conservation Technology, Inc., 2633 North Calvert Street, Baltimore, MD 21218; 410-366-1146.

Schlage, 2401 Bayshore Boulevard, San Francisco, CA 94134; 415-330-5600; www.schlagelock.com.

Stanley Hardware, The Stanley Works, New Britain, CT; 800-622-4393.

Truth Hardware, SPX Corporation, 700 West Bridge Street, Owatonna, MN 55060; 507-451-5620.

U-Change Lock Industries, Inc., 1640 West Highway 152, Mustang, OK, 73064; 405-376-1600.

Weiser Lock, 6700 Weiser Lock Drive, Tuscon, AZ 85746; 800-677-LOCK; www.powerbolt.com.

Yale Locks & Hardware, P.O. Box 25288, Charlotte, NC, 28229-8010; 800-438-1951; www.yalesecurity.com.

ESSENTIAL KNOWLEDGE

Fenestration is often blamed for water infiltration into the building envelope because these openings interrupt the path of water traveling within the building envelope (exterior waterproofing). A building must either provide a continuous impenetrable barrier or deliberately direct the flow of water with a series of lapped materials, such as flashing. Flashing is one of the longest lasting components of a building system. However, the proper installation of these materials requires experience and is time consuming. New fenestration products with integral nailing fins and the use of new exterior air/moisture barrier materials, caulks, and sealants have required reconsideration of the methods and materials used to join these products (see Section 11 and *The Rehab Guide: Exterior Walls* for further information).

Flashing must be durable, weather resistant, able to accommodate movement, and compatible with adjacent materials. The traditional overlapping assembly composed of multiple layers of flashing adjusts to movement like the scales of a fish and provides repetitive layers of resistant materials while covering the fasteners with each lap. Overlapping the material below prevents water from migrating in opposition to the forces of gravity when an unequal pressure condition exists, as in high wind storms. The longer the lap the greater the force required to draw the water upward.

Non-corrosive metals such as copper, aluminum, and lead are popular flashing materials because of their durability, malleability, and impervious nature. The proper flashing system varies among window and door types, as does the method of providing an air/moisture barrier. The introduction of integral nailing flanges and large sheets of air-permeable moisture barriers has changed the common methods of providing a water barrier (Fig. 1).

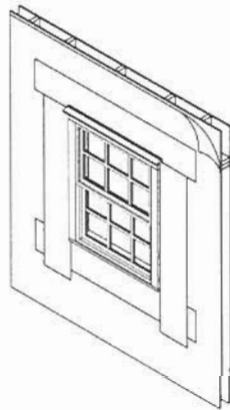

FIGURE 1

FLASHING OF INTEGRAL NAIL FLANGE WINDOW UNIT

Exterior doors have progressed similarly to windows and are now available pre-hung with casings and integral nailing fins. The traditional wood sill is a thicker profile that requires the sub flooring and/or framing to be notched to provide a level entrance and flashing to protect the framing. A soldered metal door sill pan is installed below the sill to provide a protective barrier for the framing. Most doors are now produced with either extruded metal or polycarbonate sills that resist weather and have a low profile that can be attached flush to the sub flooring and thus do not require flashing.

Repair of existing windows and doors often presents the opportunity to examine and repair existing flashing. The removal of a window or door may result in the penetration of the moisture barrier, which can be repaired with additional flashing or sealant dependent on the size of the cut-out. Compatibility of materials should be considered when combining new materials, caulking, or sealants and window units, which may produce an adverse chemical or electrolysis reaction. Materials that are separated may still create an electrolytic reaction if water is capable of bridging these two incompatible materials.

Flashing can be classified into three primary groups: sheet metal, vinyl products, and membrane/tape. Roofing underlayment, roll roofing materials, and tape products are examples of membranes. Conventional sheet metal materials include aluminum, copper, zinc, and galvanized steel, among others. Vinyl products, relatively new, are preformed in shapes suitable for particular applications. Sheet metal and vinyl flashing are appropriate for traditional assemblies of lapped materials. New continuous drainage barriers employ self-adhering membrane and tape materials to work in conjunction with doors and windows with integral nailing fins.

TECHNIQUES, MATERIALS, TOOLS

1. INSTALL SHEET METAL FLASHING.

Sheet metal flashing has proven to be one of the most durable building materials, typically capable of outlasting most other components of the envelope. The common materials, in order of durability from the most to least, are as follows: stainless steel, lead, terne coated copper, copper, galvalume, and galvanized steel. These materials are commonly available in either sheet or preformed profiles. It is important to note, however, that special consideration must be given to the selection of materials and sealants in relation to each other so as to prevent either adverse electrolytic or chemical reactions.

ADVANTAGES: The variety of sheet metal materials, able to accommodate most field conditions, provides a wide choice of finish appearance, durability, and costs. The installation of these materials is widely practiced and typically requires only a moderate level of skill.

DISADVANTAGES: Careful selection of flashing material and fabrication methods is necessary to avoid staining, electrolysis, or corrosion. Some materials such as stainless steel and galvanized steel are difficult to work with on site. The costs of these materials vary dramatically but are in relation to their anticipated lifespan.

2. INSTALL VINYL (PVC) FLASHING.

Vinyl flashing is a relatively new material that is substituted for conventional preformed sheet metal products. Being materially consistent with vinyl products for windows and doors, as well as with siding products, allows for compatibility.

ADVANTAGES: Vinyl flashing provides for a simple, inexpensive means of flashing. The material is flexible and easily cut to conform with irregular shapes. The plastic material is not subject to galvanic action with other flashing or fasteners.

DISADVANTAGES: The variety of profiles is currently limited. Vinyl lacks tensile strength and may become brittle during cold weather. Like vinyl siding the material is subject to UV degradation and chemical incompatibility.

3. INSTALL SELF-ADHERING MEMBRANE OR TAPE FLASHING.

The increasing popularity of integral nailing fins and housewrap products has led to a variety of new methods for installing window and door units. While the methods of installation are beyond the scope of this guide, new materials, such as self-adhering tape and membranes, are commonly employed as a means of joining materials as a continuous barrier or a replacement for conventional spline and sill materials. The popularity of housewrap products is primarily attributable to the fact that they may be applied in large sheets or continuous rolls, minimizing the number of seams and reducing air infiltration. The benefits associated with reduced air infiltration may also be improved with foam gasket materials that are attached to the nailing fin either on the job site or by the manufacturer. Materials are typically available from the

producers of roofing materials and housewrap products.

ADVANTAGES: The materials are easy to work with even for inexperienced users. Manufacturers claim that the membrane products self seal around penetrations of nails and fasteners. The cost relative to other products is moderate.

DISADVANTAGES: These materials are relatively new and reliant on the adhesive bond between a wide variety of materials. Common methods of installation with these materials provide little to no redundancy for failure. Some materials when exposed to ultraviolet light, sealant materials, and excessive heat may degrade.

FURTHER READING

Door and Window Installation-Builder's Series, Canada Mortgage and Housing Corporation, 1995.

Graphic Guide to Frame Construction, Rob Thallon, Newtown, CT: The Taunton Press, 1991.

"Details That Keep Walls Tight," Paul Fissette, *Building Materials and Wood Technology*, University of Massachusetts at Amherst, www.umass.edu/bmatwt/walls.html.

"Flashing Details", *Remodeling*, p.46, Mid-February 1997.

"How to Avoid Common Flashing Errors," James R. Larson, *Fine Homebuilding*, April/May 1998.

"Window Nail Flange Air Sealing Gasket," *Energy Design Update*, September 1996, p. 11.

PRODUCT INFORMATION

AFCO Products Inc., 44 Park Street, Somerville, MA 02143; 617-623-7700 (copper, aluminum, vinyl).

Benjamin Obdyke Inc., 65 Steamboat Drive, Warminster, PA 18974; 800-523-5261 (Gap Wrap wall seam tape).

Bethlehem Steel Corporation, Bethlehem, PA 18016; 800-352-5700.

Heckman Industries, 405 Spruce Street, Mill Valley, CA 94941; 800-841-0066 (Deck Seal, self-adhesive aluminum flashing).

Owens Corning, 1 Owens Corning Parkway, Toledo OH 43659; www.owenscorning.com.

Polytite, 324 Rindge Avenue, Cambridge, MA 02140; 800-776-0930; www.polytite.com.

Protecto Wrap Company, 2255 South Delaware, Denver, CO 80223; 800-759-9727.

Specialty Steel Industry of North America, 3050 K St., N.W., Washington, DC 20007; 800-982-0355; www.ssina.com.

Tamlyn and Sons, 10406 Cash Road, Stafford, TX 77477; 800-334-1676; www.tamlyn.com.

Tyvek HomeWrap, DuPont Fibers, P.O. Box 80705, Wilmington, DE 19880-0705; 800-448-9835.

W.R. Grace & Co., 62 Whittemore Ave., Cambridge, MA 02140; 800-558-7066; www.gcp-grace.com (Perm-A-Barrier wall seam tape).

CAULKING, SEALANTS & WEATHERSTRIPPING

CAULKS & SEALANTS

ESSENTIAL KNOWLEDGE

Caulks and sealants are barriers to moisture and air infiltration with the ability to accommodate movement. However, not all joints are meant to be caulked; some provide an exit for air or moisture trapped within the wall assembly. The distinction between caulks and sealants is essentially the degree of permeability (adsorption) and the ability to conform to movement. Caulk typically provides for less movement but is easier to work and is used for interior applications, while sealants are used for exterior purposes. Here, both are referred to as sealants. The selection of sealants is made more difficult by the numerous claims and confusing terminology used by the industry to distinguish products among numerous manufacturers. There is no single product that is suitable for all uses, or provides optimal properties for a specific use. Manufacturers' instructions and technical assistance should be closely followed. The selection of caulk should be guided by knowledge of the materials that are to be adhered and the material properties that are most critical, such as durability or ease of installation. The degree of durability required and the anticipated degree of movement also should be established. Movement is expressed as a percentage of the joint's width, either positive (+) for expansion or negative (-) for contraction. The temperature at the time of installation is critical so as to utilize the sealant's full range of flexibility to expand and contract. The width of the joint should be determined during mean temperatures. Small joints prove to be the most difficult to seal because the smallest movement can represent a significant percentage of expansion. Interior applications typically do not require the same degree of elasticity because the temperature is maintained within a narrow range.

Sealants have evolved with new formulations for lower cost, ease of installation, flexibility, and durability, but no one product is ideal in all these respects. Among the most common sealant types:

- Latex and oil-based sealants, generally referred to as caulks with low flexibility and relatively poor durability, are low cost and easy to work, suitable for interior applications not exposed to prolonged moisture.
- Acrylic latex, sometimes referred to as rubberized latex, is a more durable and elastic variation suitable for interior and exterior applications.
- Butyl rubber is commonly employed in insulated window assemblies because of its adhesion qualities and the ability to resist water and temperature extremes. It has only moderate flexibility and is difficult to install.
- Silicone, among the most flexible, is not generally paintable, is difficult to remove, and is not suitable for porous materials.
- Polyurethanes have excellent movement and durability characteristics, but the flexibility degrades over time and they are difficult to apply and clean up.

TYPES OF CAULKING MATERIALS

WHAT'S INSIDE THE TUBE? Most caulks have a petrochemical base such as oil, resin, butyl rubber, vinyl acrylic, acrylic, polyethylene, polyurethane, polyvinyl acetate, etc. Additives such as stabilizers, preservatives, and plasticizers give the caulks their final properties. The chart below lists the major types of caulking compounds and suggested applications

BASE TYPE	RETAIL \$ (per 10 oz)	EST. LIFE (years)	USES	CLEAN UP
Oil	1.00 - 2.00	1 - 3	Most dry surfaces *	paint thinner
Polyvinyl acetate	1.50 - 2.00	1 - 3	Indoor surfaces only *	water
Styrene rubber	2.00 - 2.50	3 - 10	Most dry surfaces *	paint thinner
Butyl	2.50 - 3.00	4 - 10	Masonry and metal **	paint thinner
Acrylic latex	2.00 - 4.00	5 - 20+	Most dry surfaces *	water
Kraton	5.00 - 7.50	10 - 15	Most dry surfaces *	paint thinner
Polyurethane	4.50 - 10.00	15 - 20+	Masonry **	acetone, MEK
Silicone	4.00 - 7.00	20+	Glass, Aluminum * (not for masonry)	paint thinner naphtha, toluene

* wood, drywall, aluminum; e.g. gaps in wood frames around perimeter of house, plumbing penetrations, gaps in rough openings around windows and doors, boots around supply and return HVAC grills, seal between bottom plates and subfloor
** gaps in masonry construction

The joint between a frame's seal plate and a masonry foundation has historically been sealed using caulk or adhesive, and can be a labor intensive process. A new alternative for sealing this and other long linear joints is foam tape. This product can be faster to apply and provides a good seal by expanding to fill gaps.

SOURCE: GREENSEAL'S CHOOSE GREEN REPORT. MARCH 1997

FIGURE 1

TYPES OF CAULKING MATERIALS

All sealants require surface preparation and appropriate primers as directed by the manufacturer. Sealants are only able to provide for movement in two directions; if the sealant contacts a third surface it will detach from the surface with the least adhesion. Sealants typically are applied with half the width adhered to either side of the opening in an hour glass shape (Fig. 2). The width of the opening is exposed on one side and must be prevented from adhering to materials along its other side with a non-adhering surface referred to as a bond breaker or backer material. The bond breaker material also serves to shape and support the profile of the sealant and serve as a secondary barrier. The breaker must be compatible

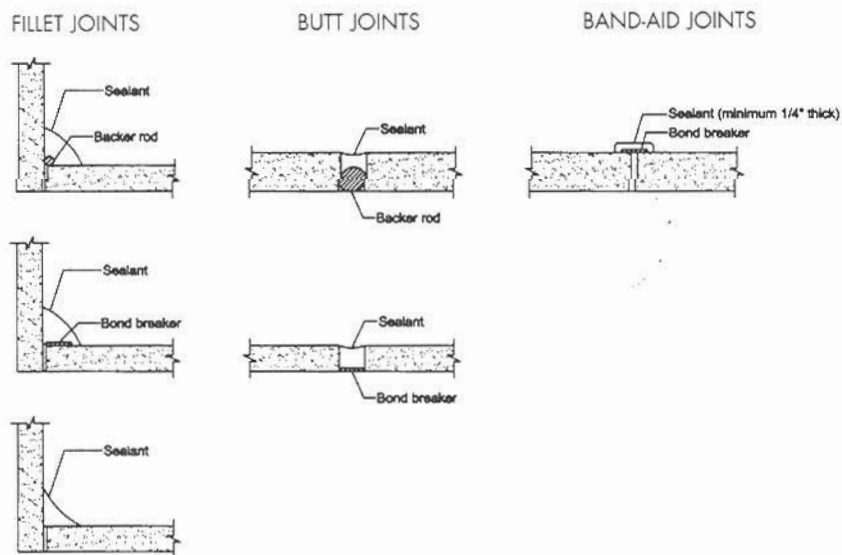

FIGURE 2

TYPICAL SEALANT JOINTS

with the sealant material and durable. Expansion (open) joints commonly use a compressible tube or rod-shaped material held in place by friction. Control (closed) joints and lap joints use a tape-like material with the sealant bridging from either side like a bandage. Although other materials are used as breakers, polyethylene and polyurethane are the most common.

TECHNIQUES, MATERIALS, TOOLS

INSTALL SEALANT MATERIALS.

Proper installation of sealant is absolutely critical to performance. The methods of installation vary among manufacturers and it is best to consult their literature for instructions. All sealants require proper preparation but the methods are beyond the scope of this book and the manufacturer's literature should be consulted. Sealants are available in essentially four types: preformed, tube, cartridge, bulk. Typically, the easier the installation method, the lower the anticipated performance. For this reason materials available in tubes tend to be water soluble caulk materials suitable for interior repairs. Materials designed for exterior purposes, specifically windows and doors, require higher performing materials and larger quantities. These materials generally require some form of mechanical means of applying the sealant. The traditional hand-operated gun provides a relatively simple device with convenient cartridges. These guns are available in several variations to provide more control over the application. Larger bulk-loading guns are also available to provide for economy in the packaging of materials or when two-part sealants are to be combined on site. Applications of large amounts of sealant are ideally suited for power-assisted equipment. Traditionally this was pneumatically driven, requiring an air compressor. New equipment developed specifically for this purpose is either electrically or battery driven. A new product, the Prazi™ Drill Mate, is attached to a conventional drill for this purpose (Fig. 3). With the requirements of application being so specific, these power tools and preformed materials provide for consistency of application.

ADVANTAGES: New automated tools and new materials provide for greater ease of installation and performance than ever before. The wide variety of materials is suitable for virtually any condition.

DISADVANTAGES: The improper selection of sealants has the potential of damaging or discoloring adjacent materials.

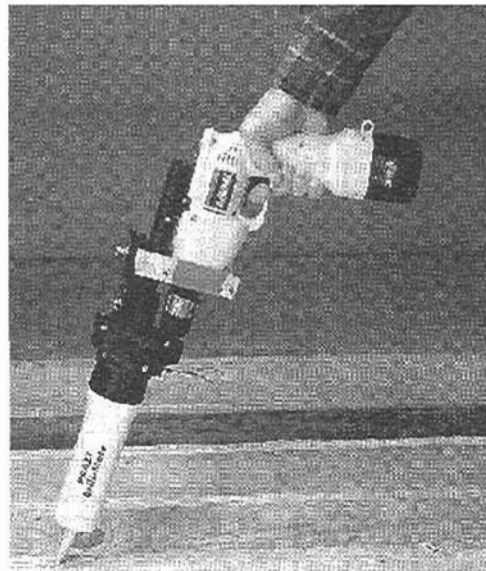

FIGURE 3

POWER CAULKING ATTACHMENT FOR CONVENTIONAL DRILL AS
MANUFACTURED BY PRAZI USA

FURTHER READING

"Building Sealing and Ventilation, Green Seal's Choose Green Report," March 1997.

"The Theory of Caulk," John Sanger, http://www.paintstore.com/book/pwc/PWC_Archives/-caulk/103.html.

Caulking, Al Brendenberg, *Today's Homeowner*, <http://index.todayshomeowner.com/todayarticles/-paint/04.97.62.html>.

"Caulking about the Weather," Josh Garskof, *Old-House Journal*, November/December 1996.

"Caulks and Sealants," *Fine Homebuilding*, Bruce Greenlaw, June/July 1990.

"Premature Sealant Failure," David H. Nicastro and Joseph P. Solinski, *The Construction Specifier*, April 1997.

"Silicone Caulking Basics," Brian Zavitz, *Fine Homebuilding*, August/September 1997.

PRODUCT INFORMATION

AEG, 3 Shaw's Cove, P.O. Box 6003, New London, CT 06320-1777.

Insta-Foam Products, Inc., 1500 Cedarwood Dr., Joliet, IL 60435; 800-800-3626.

Macklanburg-Duncan, 4041 North Santa Fe, Oklahoma City, OK 73118; 800-654-8454.

Polytite, 324 Rindge Avenue, Cambridge, MA 02140; 800-776-0930; www.polytite.com.

Prazi™ Drill Mate, Prazi U.S.A., 118 Long Pond Rd., Suite G, Plymouth, MA 02360; 508-747-1490.

Resource Conservation Technology, 2633 N. Calvert Street, Baltimore, MD 21218; 410-366-1146.

11.2

WEATHERSTRIPPING

ESSENTIAL KNOWLEDGE

While sealants provide an uninterrupted barrier between materials, weatherstripping provides for the movement of independently operating components such as door panels and window sashes. Weatherstripping resists air and water infiltration, and is also effective in reducing noise transmission and as a barrier to smoke and fire. Weatherstripping also has value for interior applications where sound resistance is desired, presuming the door panel is not hollow core, in which case the door serves to amplify the sound.

There are three basic types of weatherstripping: inter-locking assembly; compression seal; and sliding seal. Interlocking seals are arguably the most durable. Constructed of corrosion-resistant metals such as aluminum and bronze, they work best on fenestration that operates consistently and does not necessarily maintain a continuous tight seal. Occupants of older homes are familiar with such materials that, when painted or bent, will prevent the door from closing. There are six common assemblies for interlocking seals in which two corresponding materials join to form a tight fit when closed.

Compression seals, particularly in combination with a locking mechanism, generally provide a tighter and more durable barrier than a sliding seal and are utilized in most new window and door products. Compression seals are described as tube seal, flipper seal, or leaf seal. The tube seal is effective and durable but is suitable for installation with minor variation in width. Flipper and leaf seals are not as effective nor durable but can accommodate a greater variation in width. Compression seals are usually of a mate-

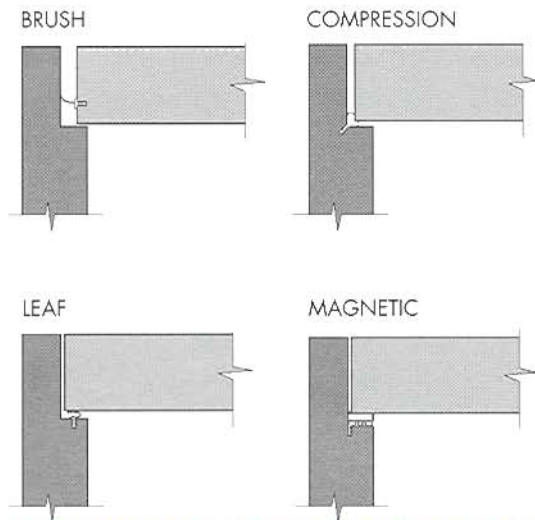

FIGURE 4

TYPES OF WEATHERSTRIPPING AT JAMB

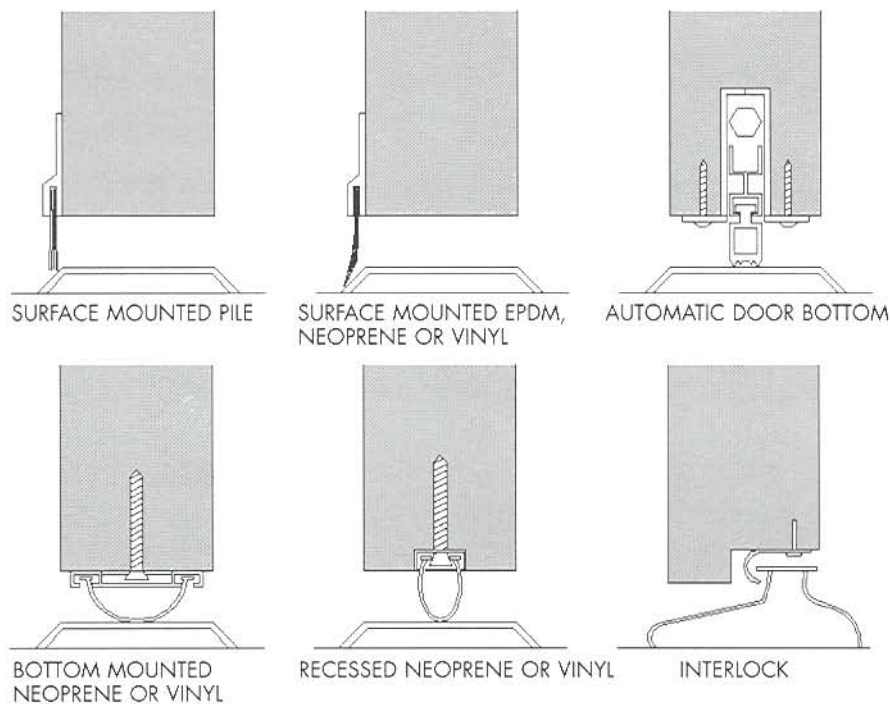

FIGURE 5

TYPES OF WEATHERSTRIPPING AT THRESHOLD

rial that returns to its original shape to provide a tight fit with the surface it is resisting. Such materials, which are said to have "memory," include silicone, EPDM rubber, neoprene, open and closed cell foam, vinyl, wool or synthetic pile, and spring metal. Silicone and EPDM both have good memory properties and remain flexible in cold temperatures. Neoprene is a less costly alternative but is not as durable or flexible under cold temperatures. Compression seals utilizing silicone, EPDM, and neoprene are the best materials for acoustical applications. These materials are attached by either mechanical fasteners, adhesive, or friction fit. A variation of the compression seal is a magnetic strip in combination with a flexible gasket. When in combination with ferrous metal doors, windows or a steel strip this assures a tight seal.

Sliding seals provide resistance to friction on sliding components and are described as sweep-sill or brush-seal. Sweep-sills have a blade-like profile. Sliding seals require materials resistant to friction, such as polypropylene or nylon. Face mounted seals are most effective because there is relatively little variation in the width of the opening. Weatherstripping may be applied by means of adhesive, by friction fit, or mechanically.

Typically the same material is used at the full perimeter, with the exception of a door sill. A threshold must be durable against wear of moving parts and traffic. Thresholds are typically fabricated of very durable materials such as metal in combination with inserts that function as tube seals either in compression or sliding (Fig. 5). A raised threshold provides contact with the sweep or seal only when the door is closed. In addition to interlocking and resilient types, door bottom seals are available as an automatic operable mechanism (Fig. 6). As a door closes a button on the hinge side of the jamb compresses a seal in a downward motion against the threshold. Weatherstripping may also be used in opposition with itself, two brushes, two flippers, or two compression seals.

The standard, "ANSI A156.22: Door Gasketing Systems," is valuable in evaluating the performance of respective weatherstripping types for appropriate selection.

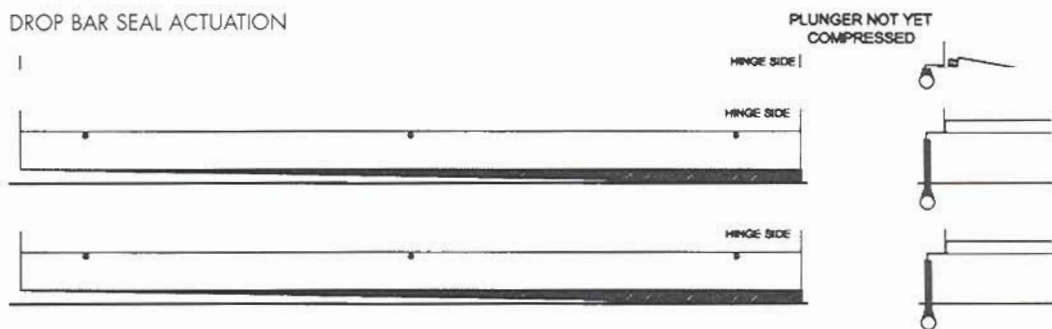

FIGURE 6

AUTOMATIC THRESHOLD SEAL

TECHNIQUES, MATERIALS, TOOLS

The majority of problems associated with doors is attributable to the installation of hardware and weatherstripping. Prior to any weatherstripping, the window or door should be repaired or determined to be properly operating. Typically the same material is applied to all sides with the exception of the door sill. The installation of new materials is a labor intensive process. When this work is to be performed by a professional only the best quality materials should be selected for they will represent a small portion of the overall cost and assure the greatest durability. Products with lower durability or effectiveness may be suitable because of the ease of installation provided to the amateur. New tools have been developed specifically for the purpose of installation, significantly reducing the skill required, and if numerous windows or doors require repair may justify the cost.

1. INSTALL NEW OR REPLACEMENT INTERLOCKING WEATHERSTRIPPING.

Interlocking weatherstripping typically requires the modification of the door or window and jamb to provide a pair of aligned components. Older windows and doors commonly employ this type and simply require replacement of these worn elements. This type allows the door or window to operate without impedance or resistance.

ADVANTAGES: Provides a very durable seal that does not impede function.

DISADVANTAGES: Does not provide for a full contact seal and requires skilled labor for new installations.

2. INSTALL NEW OR REPLACEMENT RESILIENT (COMPRESSION OR SLIDING) WEATHERSTRIPPING.

Compression and sliding types may be generally described as resilient weatherstripping. The resilience of these materials provides the opportunity to accommodate irregular surfaces and those with a tight seal achieved with full contact. Numerous products are available for this purpose with a wide variety of performance. Compression does not necessarily insure a tighter seal; manufacturer's recommendations for sizing should be carefully observed. The recently developed ANSI standard not only establishes compliance but provides guidance in the selection of appropriate materials.

ADVANTAGES: Compression materials typically provide the tightest seal and are generally very durable. Installation can usually be accomplished with a low degree of skill. New materials employed in sliding seals have significantly improved their durability while providing a tight seal. These materials are often applied to the surface of a door.

DISADVANTAGES: Resilient materials may prevent the tight closure of the door or sash, impede the function of hardware, and are generally less durable. Some materials are subject to damage under cold conditions or exposure to UV light.

3. INSTALL NEW OR REPLACEMENT DOOR THRESHOLDS.

Thresholds are available in a variety of configurations, which will determine the type of weatherstripping appropriate. Thresholds that employ a raised stop may continue the compression seal around the full perimeter. Other assemblies work in combination with either sweep or compression seals that are attached to the door unit and are compressed against the threshold. Some threshold units with integral seals are undesirable because the seals are subject to damage from foot traffic. A variation of a threshold seal is the automated door bottom that deploys a seal downward when the door is in the closed position.

ADVANTAGES: New, durable materials are designed to last many years while improving thermal performance of the assembly.

DISADVANTAGES: The replacement of the entire threshold requires a degree of skill. New, unique designs may prove to be difficult to repair in the future.

FURTHER READING

"Choosing Gasketing Products," *The Construction Specifier*, Helen Rose, April 1997.

"Retrofit Weatherstripping with Silicone Bead," *Journal of Light Construction*, Gary Katz, November 1993.

"Weatherstripping Entry Doors," *Old House Journal*, December 1986, pp.470-471.

"ANSI A156.22 Door Gasketing Systems," American National Standards Institute, available from the Builders Hardware Manufacturers Association.

PRODUCT INFORMATION

Accurate Metal Weatherstripping Co. Inc. , 725 S. Fulton Ave., Mount Vernon, NY 10550; 914-668-6042.

Macklanburg-Duncan, 4041 North Santa Fe, Oklahoma City, OK 73118; 800-654-8454.

Pemko Co., Box 3780, Ventura, CA 93006; 805-642-2600.

Resource Conservation Technology, 2633 N. Calvert Street, Baltimore, MD 21218; 410-366-1146.

Schlegel Corp., Retroseal Division, P.O. Box 23197, Rochester, NY 14692; 800-828-6237.

Weatherbead Insulation Systems, 47-46-46 Hepburn Dr., Indio, CA 92201; 800-966-0159.

Zero International, 415 Concord Ave., Bronx, NY 10455; 212-585-3230.

SHUTTERS & AWNINGS

ESSENTIAL KNOWLEDGE

Shutters and awnings were the means in the past by which windows and doors were shaded or protected from storms and other intrusions. Although their original functions have been addressed by other means such as air conditioning and security systems, they remain popular decorative elements. To maintain a house's historic character, they occasionally need to be repaired or replaced. Shutters have proliferated as applied, fixed units made of contemporary, low-maintenance materials. The desire for historical authenticity and environmental concerns have also created a demand for authentic operating wood shutters, and the function of shutters and awnings is now being reevaluated.

Operable shutter louvers allow control of heat gain and glare, while providing diffuse light and promoting natural ventilation through a house and preserving some degree of privacy. Awnings provide an effective means of shade, reflecting 80% to 90% of sunlight without obstructing the view, but some awnings trap heated air against windows. Shutters also have been revived as a means of protecting windows on homes built in high-wind regions.

New innovations include automated operation and more durable materials. Traditionally made of disease-resistant wood species, shutters are now available in aluminum and vinyl. High wind or hurricane-resistant shutters require the strength of aluminum. Awnings, once exclusively manufactured of canvas, now employ new, dimensionally stable and rot-resistant fabric materials that can withstand prolonged exposure to ultra violet light, and significantly reduce maintenance. The repair of existing shutters may use similar methods and materials, well documented in "how to" repair books. Awnings require regular replacement of the fabric, presenting the opportunity to employ more durable materials.

TECHNIQUES, MATERIALS, TOOLS

1. REPAIR EXISTING SHUTTERS AND AWNINGS.

Conventional shutters and awnings may be repaired by traditional methods as described in the window frame section. Awnings are typically designed for ready replacement of the fabric material. Several sources of replacement materials are identified under product information.

ADVANTAGES: Repair of existing units with common methods will preserve authenticity and improve durability. New materials available have significantly improved the anticipated life span of these materials.

DISADVANTAGES: The selection of original shutters or awnings may have been inappropriate and make them difficult to maintain.

2. REPLACEMENT OF SHUTTERS AND AWNINGS.

New shutters and awning products provide greater convenience, security, and durability.

ADVANTAGES: New products often provide distinct advantages previously unavailable. Apart from the convenience of operation or increased durability new storm shutters and shading devices provide tangible benefits in lower energy consumption and possibly reduced insurance premiums.

DISADVANTAGES: Authentic shutters and awnings are typically expensive to replicate.

FURTHER READING

Residential Windows, John Carmody, Stephen Selkowitz, and Lisa Hescong, New York: W.W. Norton, 1996.
"Serious Shutters," Brad Lemley, *This Old House*, July/August 1996, pp. 88-91.

PRODUCT INFORMATION

TRADITIONAL WOOD SHUTTERS

Cobblestone Mill Woodworks, Inc., 802 Tom Charles Lane, Canton, GA 30115; 800-591 4597.

Vixen Hill Manufacturing Company, Main Street, Elverson, PA 19520; www.vixenhill.com.

Kestrel Shutters, P.O. Box 12, St. Peters, PA 19470; 800-494 4321; www.DIYShutters.com.

METAL AND FABRIC AWNINGS

American Building Products by Hindman Manufacturing Co., P.O. Box 1808, Centralia, IL 62801; 800-851-0865.

Dickinson Elberton Mills, Inc., 120 Seaboard Street S.E., Elberton, GA 30635; 800-433-1748.

Somfy Systems, Inc., 47 Commerce Drive, Cranbury, NJ 08512; 609-395-1300 (control mechanisms).

Sunbrella, Glen Raven Mills, Inc., Glen Raven, NC 27217; 910-227-6211.

STORM RESISTANT SHUTTERS

Aluminum Service, Inc., 2021 North 40th Street, Tampa, FL, 33605; 813-247-4667; www.aserv.com.

Roll-A-Way, Inc., 10601 Oak Street N.E., St. Petersburg, FL 33716; 800-683-9505.

APPENDIX

PROFESSIONAL ASSOCIATIONS & RESEARCH CENTERS

ADHESIVE AND SEALANT COUNCIL
1627 K Street, NW
Suite 1000
Washington, DC 20006-1707
202-452-1500
www.ascouncil.org

AMERICAN ARCHITECTURAL
MANUFACTURER'S ASSOCIATION
1827 Walden Office Square, Suite 104
Schaumburg, IL 60173
847-303-5664
www.AAMAnet.org

AMERICAN NATIONAL STANDARDS INSTITUTE
11 West 42nd Street, 13th Floor
New York, NY 10036
212-642-4900
www.ansi.org

AMERICAN SOCIETY OF CIVIL ENGINEERS
1801 Alexander Bell Drive
Reston, VA 20191-4400
800-548-2723
www.asce.org

AMERICAN SOCIETY OF HEATING,
REFRIGERATING, AND AIR-CONDITIONING
ENGINEERS (ASHRAE)
1791 Tullie Circle, NE
Atlanta, GA 30329
404-636-8400
www.ashrae.org

AMERICAN SOCIETY FOR TESTING AND
MATERIALS
100 Barr Harbor Drive
West Conshohocken, PA 19428
610-832-9500
www.astm.org

ASSOCIATION OF WINDOW AND DOOR
INSTALLERS
11300 US Highway 1, Suite 400
North Palm Beach, FL 33408-3296
561-691-6224

BUILDERS HARDWARE MANUFACTURERS
ASSOCIATION
355 Lexington Avenue, 17th Floor
New York, NY 10017
212-661-4261
www.buildershardware.com

CANADA MORTGAGE AND HOUSING
CORPORATION
HOUSING INFORMATION CENTER
700 Montreal Road
Ottawa, ON, Canada K1A 0P7
613-748-2367
www.cmhc-schl.gc.ca

CONSTRUCTION SPECIFICATIONS INSTITUTE
601 Madison Street
Alexandria, VA 22314
703-684-0300
www.csinet.org

COUNCIL OF AMERICAN BUILDING OFFICIALS
5203 Leesbug Pike
Suite 708
Falls Church, VA 22041
703-931-4533
www.intlcode.org

DOOR AND HARDWARE INSTITUTE
14170 Newbrook Drive,
Chantilly, VA 20151-2232
703-222-2010
www.dhi.org

HOME ENERGY RATING SYSTEMS COUNCIL
1331 H St., NW, Suite 1000
Washington, DC 20005
202-638-3700
www.hers-council.org

FLORIDA SOLAR ENERGY CENTER (FSEC)
1679 Clearlake Road
Cocoa, FL 32922
407-638-1000
www.fsec.ucf.edu

INTERNATIONAL REMODELING
CONTRACTORS ASSOCIATION
1 Regency Drive
Bloomfield, CT 06002
800-937-4722

INTERNATIONAL STANDARDS ORGANIZATION
1, rue de Varembe
Case postale 56
CH-1211 Gene've 20, Switzerland
41-22-749-01-11
<http://iso.ch/welcome.html>

INTERNATIONAL WINDOW FILM ASSOCIATION
P.O. Box 42033-383
Pheonix, AZ 85080-2033
602-595-9758

LAWRENCE BERKELEY NATIONAL
LABORATORY
Building Technologies Program
Energy and Environment Division
Lawrence Berkeley Laboratory, Berkeley, CA
94721
510-486-6844
eandelbl.gov/BTP/BTP.html

NAHB REMODELORS COUNCIL
1201 15th Street, NW
Washington, DC 20005
202-822-0212
www.nahb.com/remodelc.html

NATIONAL ASSOCIATION OF ARCHITECTURAL
METAL MANUFACTURERS
8 S. Michigan Ave., Suite 1000
Chicago, IL 60603-3305
312-456-5590

NATIONAL ASSOCIATION OF THE
REMODELING INDUSTRY
4900 Seminary Road, Suite 320
Arlington, VA 22311
703-575-1100
www.nari.org

NATIONAL FIRE PROTECTION ASSOCIATION
1 Batterymarch Park
Quincy, MA 02269-9101
800-344-3555

NATIONAL FENESTRATION RATING COUNCIL
1300 Spring Street, Suite 500
Silver Spring, MD 20910
301-589-6372
www.nfrc.org

NATIONAL GLASS ASSOCIATION
8200 Greensboro Dr., Suite 302
McClean, VA 22102
703-442-4890
www.glass.org

NATIONAL TECHNICAL INFORMATION SERVICE
US Department of Commerce
www.fedworld.gov/ntis/ntishome.htm

OAK RIDGE NATIONAL LABORATORY
Building Envelope Systems and Materials
P.O. Box 2008
Oak Ridge, TN 37831-6070
423-574-4345
www.cad.ornl.gov/kch/demo.html

PASSIVE SOLAR INDUSTRIES COUNCIL
1331 H Street, NW, Suite 1000
Washington, DC 20005
202-628-7400
www.psic.org

SCREEN MANUFACTURERS ASSOCIATION
2545 S. Ocean Blvd., Suite 410
Palm Beach, FL 33480
773-525-2644

STEEL WINDOW INSTITUTE
1300 Sumner Avenue
Cleveland, OH 44115
216-241-7333

STEEL DOOR INSTITUTE
30200 Detroit Road
Cleveland, OH 44145-1967
216-899-0010

U.S. DEPARTMENT OF ENERGY
Building Systems and Materials Division
EE-421
1000 Independence Avenue, SW
Washington, DC 20585
202 586 9214
www.doe.gov

U.S. DEPARTMENT OF ENERGY'S EREN
Energy Efficiency and Renew. Energy Network
www.eren.doe.gov

U.S. DEPARTMENT OF ENERGY'S EREC
Energy Efficiency and Renew. Energy
Clearinghouse
P.O. Box 3048
Merrifield, VA 22116
800-363-3732
www.eren.doe.gov/erec/

U.S. GOVERNMENT'S FEDERAL INFORMATION
NETWORK
www.fedworld.gov/

U.S. DEPARTMENT OF HOUSING
AND URBAN DEVELOPMENT
HUD User
P.O. Box 6091
Rockville, MD 20849
www.huduser.org
800-245-2691

VINYL WINDOW AND DOOR INSTITUTE
355 Lexington Avenue
New York, NY 10017

WINDOW & DOOR MANUFACTURERS
ASSOCIATION
1400 East Touhy Avenue, Suite 470
Des Plaines, IL 60018-3337
847-299-5200
www.wdma.com

THE REHAB GUIDE

VOLUME ONE: FOUNDATIONS

VOLUME TWO: EXTERIOR WALLS

VOLUME THREE: ROOFS

VOLUME FOUR: WINDOWS & DOORS

VOLUME FIVE: PARTITIONS, CEILINGS, FLOORS & STAIRS

VOLUME SIX: KITCHENS & BATHS

VOLUME SEVEN: ELECTRICAL/ELECTRONICS

VOLUME EIGHT: HVAC/PLUMBING

VOLUME NINE: SITE WORK

U.S. Department of Housing and Urban Development
Washington, DC 20410-6000

Official Business
Penalty for Private Use, \$300

May 1999
HUD-0000-PDR

