

Cityscape

*A Journal of Policy
Development and Research*

HOUSING TECHNOLOGY PROJECTS
VOLUME 25, NUMBER 1 • 2023



PD&R



Managing Editor: Mark D. Shroder
Associate Editor: Michelle P. Matuga

Advisory Board

Dolores Acevedo-Garcia
Brandeis University

Ira Goldstein
The Reinvestment Fund

Richard K. Green
University of Southern California

Mark Joseph
Case Western Reserve University

Matthew E. Kahn
University of California, Los Angeles

C. Theodore Koebel
Virginia Tech

Jens Ludwig
University of Chicago

Mary Pattillo
Northwestern University

Carolina Reid
University of California

Patrick Sharkey
New York University



PD&R

Cityscape

*A Journal of Policy
Development and Research*

HOUSING TECHNOLOGY PROJECTS
VOLUME 25, NUMBER 1 • 2023

U.S. Department of Housing and Urban Development
Office of Policy Development and Research

The goal of *Cityscape* is to bring high-quality original research on housing and community development issues to scholars, government officials, and practitioners. *Cityscape* is open to all relevant disciplines, including architecture, consumer research, demography, economics, engineering, ethnography, finance, geography, law, planning, political science, public policy, regional science, sociology, statistics, and urban studies.

Cityscape is published three times a year by the Office of Policy Development and Research (PD&R) of the U.S. Department of Housing and Urban Development (HUD). Subscriptions are available at no charge and single copies at a nominal fee. The journal is also available on line at huduser.gov/periodicals/cityscape.html.

PD&R welcomes submissions to the Refereed Papers section of the journal. Our referee process is double blind and timely, and our referees are highly qualified. The managing editor will also respond to authors who submit outlines of proposed papers regarding the suitability of those proposals for inclusion in *Cityscape*. Send manuscripts or outlines to cityscape@hud.gov.

Opinions expressed in the articles are those of the authors and do not necessarily reflect the views and policies of HUD or the U.S. Government.

Visit PD&R's website, huduser.gov, to find this report and others sponsored by PD&R. Other services of HUD USER, PD&R's Research and Information Service, include listservs, special interest and bimonthly publications (best practices, significant studies from other sources), access to public use databases, and a hotline (1-800-245-2691) for help with accessing the information you need.

Contents

Symposium

Housing Technology Projects 1

Guest Editors: Mike Blanford and Kent Watkins

Guest Editors' Introduction

Recent Findings and Results of Grants from the Cooperative Research in Housing Technologies Program: Where Do They Fit Within the Framework of the Past 55 Years of Housing Technology Innovation at HUD? 3

Increasing Innovation and Affordability in Housing: A Case Study on Townhome Area Separation Walls 17
by Christine Barbour and James Lyons

Advanced Modular Housing Design: Developing the CORE+ 37
by Jeff Carney, Ravi Srinivasan, Stephen Bender, Bill O'Dell, Ryan Sharston, Abdol Chini, and Forough Foroutan

Getting Cross-Laminated Timber into U.S. Design Codes: A Must for Affordable and Sustainable Multifamily Housing 57
by John W. van de Lindt, Maria Koliou, and Pouria Bahmani

Designing for Natural Hazards: Resilience Guides for Builders and Developers 71
by John B. Peavey, Nay B. Shah, Chinedu Moneke, Kevin Kauffman, and Elina Thapa

Modeling and Analyzing Distributed Heat Pump Domestic Water Heating in Modular Multifamily Buildings 89
by Victor Braciszewski, Stet Sanborn, Justin Tholen, Harshana Thimmanna, Tyler Pullen, Carol Galante, and Jamie Hiteshew

Factory Complete Heating and Cooling Solutions for Manufactured Homes 117
by Emanuel Levy, Jordan Dentz, and Yi-Jia Liao

Exploring the Potential of Factory Installed Solar + Storage for Homebuilding 145
by Isabelina Nahmens, Ondřej Labík, Alison Donovan, Kalee Whitehouse, Damon Lane, Desmond Kirwan, Leslie Badger, Ankur Podder, and Shanti Pless

3D Concrete Printed Houses: Barriers to Adoption and Construction Practices 163
by John B. Peavey, Ed Hudson, Zachary A. Summy, and Jon Violette

Seismic Design Methodology for 3D Printed Concrete Buildings 177
by Mohammad Aghajani Delavar, Hao Chen, and Petros Sideris

Residential House Foundations on Expansive Soils in Changing Climates 199
by Nafisa Tabassum and Rifat Bulut

Refereed Papers 213

Moving to Problems: Unintended Consequences of Housing Vouchers for Child Welfare-Involved Families..... 215
by Patrick J. Fowler, Andrew Foell, Anne K. Rufa, and Michael Schoeny

Departments..... 237

Data Shop

Move-In Fees as a Residential Sorting Mechanism Within Online Rental Markets..... 239
by Remy Stewart, Chris Hess, Ian Kennedy, and Kyle Crowder

Foreign Exchange

The Role of Forbearance in Sustaining Low-Income Homeownership: Evidence from Norway’s Public Starter Mortgage Program 253
by Anna Maria Santiago and Kristin Aarland

Graphic Detail

Neighborhood Incarceration Rate Hot Spots in Maryland 275
by Alexander Din

Visualizing Spanish Speaking Limited English Proficiency and Hispanic Populations in Fort Collins, Colorado 281
by Brent D. Mast and Tricia Ruiz

Impact

Regulatory Impact Analysis of Manufactured Home Construction and Safety Standards 287
by Michael Hollar

Industrial Revolution

A Cost-Benefit Analysis of FORTIFIED™ Home Designation in Oklahoma 303
by Somik Ghosh, Ben F. Bigelow, Alexander Smith, and Olayinka Omole

Concept of Thermal Bridging in Wood Framed Construction..... 315
by Shawn P. Kelley and Mike Blanford

Symposium

Housing Technology Projects

Guest Editors: Mike Blanford and Kent Watkins

Guest Editors' Introduction

Recent Findings and Results of Grants from the Cooperative Research in Housing Technologies Program: Where Do They Fit Within the Framework of the Past 55 Years of Housing Technology Innovation at HUD?

Mike Blanford

U.S. Department of Housing and Urban Development

Kent Watkins

American Academy of Housing and Communities

The views expressed in this article are those of the authors and do not represent the official positions or policies of the Office of Policy Development and Research, the U.S. Department of Housing and Urban Development, the U.S. Government, or the academy.

This symposium presents findings and results from the research program Cooperative Research in Housing Technologies (CRHT), sponsored by the U.S. Department of Housing and Urban Development (HUD). HUD managed a total of 10 CRHT grants from fiscal year (FY) 2019 to 2022. This issue includes articles on all 10 projects.

HUD's mission is *to create strong, sustainable, inclusive communities and quality affordable homes for all*. Housing technology researchers often view "quality affordable homes" through a technology lens by seeking the next housing innovation that will solve the affordable housing crisis

or resolve issues of affordability in general.¹ Advanced housing technology itself is not a panacea for the affordability of housing. In fact, HUD research has shown that a new paradigm in housing technology can take 15 to 25 years to achieve its full market potential (Koebel et al., 2004). In a recent survey of 300 home builders, Home Innovation Research Labs found that home builders were more likely to adopt a new technology that improved the performance of their homes rather than reduced the cost of construction (exhibit 1) (Hudson, 2022). Although that may be true, a builder has a logical limit to the ability to absorb those costs or articulate the value to a homebuyer customer while doing nothing to address the overall question of affordability.

Exhibit 1

Homebuilders' Motivation to Adopt New Technologies

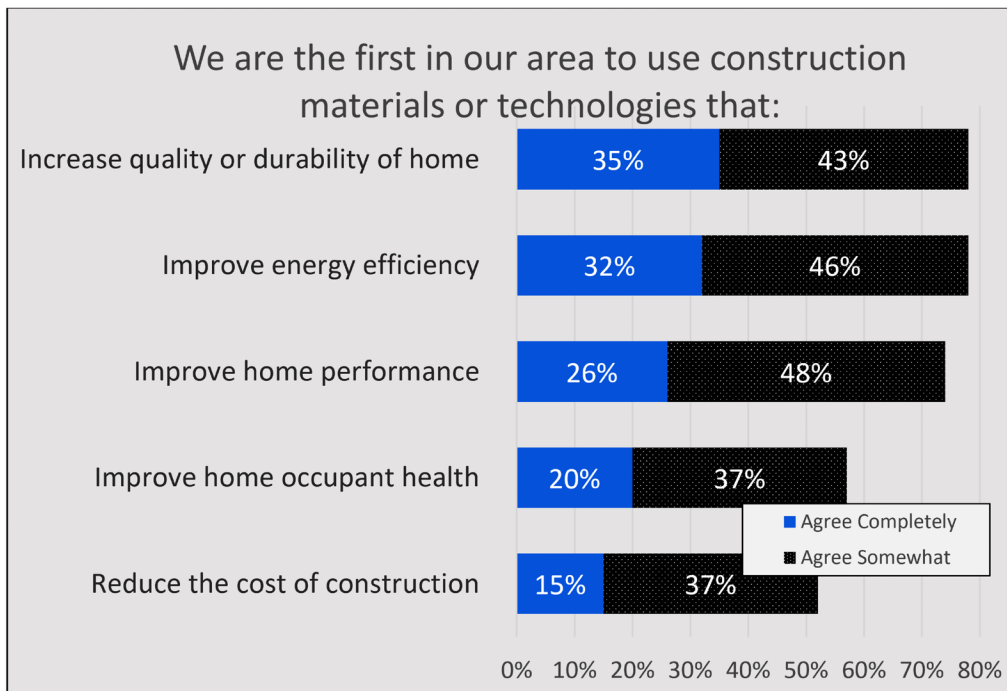

Source: Hudson, 2022

Almost from its inception, HUD has attempted to assist in improving the affordability and durability of the nation’s housing stock through investments in science and technology. However, significant challenges to such improvements, such as land use and zoning requirements, raise barriers to affordability; building codes do not support innovation; risk aversion is widespread among builders, developers, and consumers; and lack of investment in innovative housing technologies poses a challenge. The role of HUD has been to sponsor studies and demonstrations that better inform

¹ For purposes of this article and symposium, the terms *innovation* and *technology* are used interchangeably and limited in scope. Thus, innovation/technology is the introduction of something new that results in an improvement of function or performance. Homebuilding innovations can include new construction methods, materials, techniques, processes, or products that greatly improve the functions of homes.

regulators, builders, developers, and consumers as they make decisions that affect the housing market and make significant impacts on the supply and availability of affordable housing.

Short History of Housing Technology Research at HUD²

Before the creation of HUD in 1965, federal research, development, and demonstration activities related to housing, metropolitan growth, and urban problems were relatively small, disparate projects. Efforts in the 1930s and 1940s by New Deal agencies such as the Federal Housing Administration, Tennessee Valley Authority, Farm Security Administration, and Federal Emergency Relief Administration; prefabricated defense housing; and the postwar Veterans' Emergency Housing Program were exceptions to that observation.³ Also notable were the Housing Acts of 1948 and 1949 for promoting technical research to improve housing construction and affordability. The 1950s also saw some Levittown communities and other mass-produced housing, at least with some modular or prefabricated components.

In the 1960s, following several advisory committee evaluations and recommendations, the Demonstration Cities and Metropolitan Development Act of 1966, Section 1011, directed HUD, led by Secretary Robert C. Weaver, to conduct research about the “ecological factors involved in urban living” as well as studies and demonstrations on ways to apply innovative technologies to housing construction, rehabilitation, and maintenance and to urban development activities.⁴

Thus began the two distinct objectives for research to reach the 1949 Act's goal of “a decent home and a suitable living environment for every American family.”^{5,6} In this article, the authors follow the latter track. Within that track, later research on improvements in housing production would disaggregate into researching construction techniques and how to overcome regulatory barriers that drive up the cost of production.

In 1967, HUD commissioned a study and report by the National Research Council of the National Academies of Sciences and Engineering (NRC) on recommendations for “long-range planning for R&D [research and development]” at HUD (NRC, 1969). NRC came down mainly on the side of the first strategy of social intervention, but it did recommend that HUD focus (1) on ways to use currently available technology—such as improvements in factory-produced housing—and (2) only secondarily on the pursuit of research opportunities in new technology.

Section 108, HUD Act of 1968: A Vital Authorization for Building-Technology Advancement

The 1968 Housing and Urban Development Act looked beyond the annual vision and instead established a 10-year housing goal of 26 million new homes, 6 million of them for low- and

² For a more thorough review of the history of HUD housing technology research programs see NRC, 2008.

³ Many of these exceptions were efforts to actually build housing that supported their programs, so the research could be implemented quickly in the construction of large numbers of houses.

⁴ Sec. 101, Pub. L. 89-754, 80 Stat. 1255 (November 3, 1966).

⁵ Sec. 2, Pub. L. 171, 63 Stat. 432 (July 17, 1949).

⁶ For more on the tension between technology and social science research at HUD, see HUD (2016).

moderate-income families. Ultimately, more than 17 million homes were built from 1969 to 1979. The same act's Section 108 directed HUD to encourage the use of new technologies in the development of low-income housing.

That mandate called for HUD to solicit and approve no more than five plans by public or private entities for the development of low-income housing "using new and advanced technologies...where local building regulations permit the construction of experimental housing" or where local zoning laws permit variances for the construction of "experimental housing."⁷

In addition to encouraging the use of new technology in low-income-housing production, the demonstration was meant to "encourage large-scale experimentation in the use of such technologies."^{8,9}

Before Secretary Weaver left office after the 1968 presidential election, HUD began to implement the mandate of Section 108 of the 1968 HUD Act.

Austin Oaks, Surplus Lands, and In-Cities Demonstrations to Jump-Start Section 108 and Operation Breakthrough

In December 1968, President Lyndon Johnson dedicated a 10-unit building technology demonstration known as Austin Oaks. He used the dedication to discuss the Housing Act of 1968 that had passed earlier that year, his role in implementing the first public housing in the nation more than 30 years earlier, and the national challenges that remained as his presidency ended.

The housing design competition prized speed, affordability, and energy efficiency, so several National Aeronautics and Space Administration space shuttle fabricators designed and built homes in the cul-de-sac (Wilson, 2021). As part of the pilot program, an interdisciplinary research team from the University of Texas at Austin deployed engineers to measure the energy performance of the 10 homes over time, and concurrently, a team of sociologists and architects used participatory design techniques to answer the question, Can families of different races live together?

That pilot program, although small in stature, illuminates the tensions within federal government approaches of the late 1960s: a belief in the top-down application of space-age technology to solve complex social problems while also endeavoring to embrace the bottom-up practices of participatory design that were coming out of the civil rights movement.

In addition, the outgoing administration had initiated through the Office of Urban Technology and Research an experimental housing project to study how zoning, building codes, labor rules, and local financial and administrative policies constrain the rapid adoption of cost-saving housing production technologies. This project was called the "in-cities" Experimental Housing Project. The Office of Urban Technology and Research advised the incoming administration that one of the most important R&D matters requiring HUD's attention was the development of a major innovative housing demonstration potentially ten times the size of the in-cities experiment in response to Section 108 of the 1968 Act.

⁷ Sec. 108, Pub. L. 90-448, 82 Stat. 476 (August 1, 1968).

⁸ Sec. 108, Pub. L. 90-448, 82 Stat. 476 (August 1, 1968).

⁹ Administratively, from 1967 to 1969, the title of the R&D office switched from Urban Technology and Research to Urban Research and Technology and then simply to Research and Technology.

Under the direction of the Urban Renewal Administration at HUD, the White House coordinated a Surplus Lands Community Development Demonstration. The sites included Fort Lincoln and the former National Training School for Boys in the District of Columbia. One of the goals was to be a national showcase for the practical application of new systems and technologies in architecture, site development, and construction. Others were at Louisville, Kentucky; San Antonio, Texas (Fort Sam Houston); and San Francisco (Fort Funston and Fort Miley). Thus was born the foundation for the next generation of housing technology: Operation Breakthrough under the next secretary, George Romney.

Continuation of R&D Housing Technology Programs Under Secretary Romney (1969–72)

Secretary George Romney and his staff reviewed the various housing technology research and demonstrations begun by the preceding administration and transferred those initiatives to a new brand name: Operation Breakthrough.¹⁰ The program was outlined in May 1969 at meetings held by HUD with members of the building industry, labor unions, and state and local governments under a new assistant secretary for research and technology, Harold B. Finger (exhibit 2).

Exhibit 2

Photo of HUD Secretary Romney and Assistant Secretary for Research and Technology Finger, circa 1969



Harold B. Finger (far left) and Secretary Romney (far right). Photo credit: Art Rosfeld.

¹⁰ Secretary Romney had served as president of American Motors Corporation before his election as governor of Michigan prior to his service as Secretary.

Further research authority evolved with the passage of Title V of the 1970 Housing and Urban Development Act, which reemphasized Section 108 of the 1968 HUD Act. It stated “the Secretary shall require, to the greatest extent feasible, the employment of new and improved technologies, methods, and materials in housing construction, rehabilitation, and maintenance...with a view to reducing costs, and shall encourage and promote the acceptance and application of such advanced technology, methods, and materials by all segments of the housing industry...”¹¹

Operation Breakthrough 1969–75

Operation Breakthrough, which continued the demonstrations from the 1968 Housing Act, was a demonstration program that supported national industrial manufacturers in trying their hand at the industrialization of home building, with specific focus on improving production volume. Ultimately, Operation Breakthrough produced nine prototype housing projects on sites nominated by local and state governments, representing urban peripheral, suburban, and semirural neighborhoods. It built nearly 3,000 units from 1971 to 1973. During FY 1971, however, Congress approved only \$30 million for HUD research and technology, and other issues led to attacks on the demonstration.

By 1975, Finger’s successor, Michael H. Moskow, drew down the curtain on Operation Breakthrough with his Report Number 4, summarizing the pluses and minuses. More importantly, two things occurred: HUD reorganized the office to include policy, which broadened the technical focus by means of new staff and leadership, and which had an emphasis different from technology—namely, that of the second strategy of the social science experiments, such as the Experimental Housing Allowance Program. No more large-scale technology experiments have been conducted through the present time.

Solar Demonstration Program

The Solar Demonstration Program of 1975–82 consisted of the Solar Heating and Cooling Demonstration Program and the Passive Solar Residential Design Competition. Both programs were created to respond to the energy crisis of the early 1970s.

The Solar Demonstration Program was intended to help bring the solar industry to the point that it could economically serve the housing industry with efficient and cost-effective heating and cooling equipment. During the life of the program, HUD awarded 943 grants, and solar systems provided hot water, space heating, or space cooling for 10,098 dwelling units (HUD, 1976; NRC, 1985).

The Passive Solar Residential Design Competition was a competition and award program to encourage the design, construction, and marketing of passive solar homes (HUD, 1980). That initiative was the first time the federal government conducted activities that directly supported the promotion of a technology to consumers.¹² The program also helped serve as the technical foundation for energy efficiency improvements that have been made in the residential sector.

¹¹ Housing and Urban Development Act of 1970, Title V, §§ 501–504, Pub. L. 91–609, 84 Stat. 1784–1786 (December 31, 1970).

¹² It is important to note that HUD’s engagement with American housing is limited largely to the residential affordable rental properties administered by the Office of Public and Indian Housing and the Office of Housing. Other HUD programs typically provide financing only for existing or new housing, with virtually no technical engagement by HUD.

Small Directed Research Activities 1980s–90s

During the 1980s and 1990s, HUD conducted small research activities across a number of topical areas rather than a specific major initiative. The most significant of those activities was work to advance understanding of alternatives to wood framing.¹³ HUD supported the development of building code provisions for three alternatives to wood framing: light-gauge steel framing, structural insulated panels, and insulating concrete forms. HUD published numerous research reports on all three alternatives, often in close collaboration with industry stakeholders. HUD also conducted research to develop lead paint regulations. That focus ultimately led HUD to establish the Office of Lead-Based Paint. Finally, HUD research supported improved regulations for the manufactured-housing industry. The research included activities on wind safety, fire safety, permanent foundations, metal roof installation, and energy standards (HUD, 1996).

Partnership for Advancing Technologies in Housing, 1998–2008

However, what had been dropped in the post-Operation Breakthrough studies—building technologies—was taken up again in the late 1990s under the Clinton Administration, albeit with a different emphasis. The Partnership for Advancing Technologies in Housing’s (PATH’s) mission was to collaborate with public- and private-housing-industry experts to expand the development and use of new technologies that make American homes safer, more durable, and more energy efficient without sacrificing affordability. That emphasis was based on findings by the National Science and Technology Council (NSTC), which developed the National Construction Goals in the mid-1990s (NSTC, 1995). National Construction Goals stipulated—

- 50 percent reduction in project delivery times.
- 50 percent reduction in operations, maintenance, and energy costs.
- 30 percent increase in occupant productivity and comfort.
- 50 percent fewer facility-related illnesses and injuries.
- 50 percent less waste and pollution.
- 50 percent greater durability and flexibility.
- 50 percent reduction in construction illnesses and injuries.

Thus, technological innovation was geared toward construction quality and sustainability rather than the industrial production focus of Operation Breakthrough. Investments in innovation appear to be associated with the cyclical nature of the housing industry (Martin and McCoy, 2019). Thus, the demise of the PATH program coincided with the recession in 2008. At that time, support for the PATH program waned both in Congress and at HUD.

¹³ This effort led to the development of building code provisions for light-gauge steel framing, structural insulated panels, and insulating concrete forms, which are notable because homes built with those technologies are almost exclusively in the private market, with little HUD engagement.

Sustainable Construction in Indian Country, 2011–16¹⁴

In HUD's Fiscal Year 2010 Appropriations Act, Congress enacted the Transformation Initiative, which made up to 1 percent of program funds available for (1) research, evaluation, and program metrics; (2) program demonstrations; (3) technical assistance; and (4) information technology. The Sustainable Construction in Indian Country (SCinIC) initiative was a congressionally mandated effort of the Transformation Initiative. SCinIC sought to promote and support sustainable construction practices in Native communities and thereby help tribes provide their members with healthier, more comfortable, and more resource-efficient homes.

The initiative consisted of several interrelated activities. HUD, other federal agencies, and key stakeholders worked to identify and overcome barriers to the adoption of sustainable construction practices in Indian country. Participating tribes also received technical assistance to support their adoption of sustainable construction practices in residential construction or rehabilitation projects, and HUD provided training on sustainable construction practices.

Cooperative Research in Housing Technologies, 2019–Present

Cooperative Research in Housing Technologies is a current HUD housing technology research effort. The CRHT program represented a HUD response to a recommendation by the National Research Council (NRC, 2008). Specifically, Recommendation 4-2 stated that HUD “should provide small research grant competitions...that focus on basic and enabling research in technology and maintain a distance from implicit product endorsement or demonstration” (NRC, 2008). With that recommendation in mind, HUD sought applications for “co-operative agreements for pre-competitive research in homebuilding technologies that provide the homebuilding industry with new, innovative construction products or practices that lead to more affordable, energy efficient, resilient,¹⁵ and healthier housing” (NRC, 2008). Two notices of funding opportunities were published: in April 2019 and May 2020.¹⁶

It is important to note that the basic goals of HUD building technology research programs have remained the same through the years. It is imperative that HUD building technology research continue focusing on affordability and volume production. Among federal agencies involved in housing, affordability is a concern unique to HUD. However, much has changed in the past 57 years. The threat of climate risk and energy insecurity are now important considerations in addition to the ultimate goal of expanding access to quality affordable housing at all income levels. As a result, readers will recognize that many of the symposium articles have a primary or secondary focus on energy efficiency, resilience, and/or healthy housing, but all are grounded in affordability.

¹⁴ For more information on the Sustainable Construction in Indian Country initiative, see <https://www.huduser.gov/portal/SCinIC/home.html>.

¹⁵ *Resilient* refers to a technology that provides durability and is disaster resistant, adaptable for future requirements, and maintainable.

¹⁶ Two other funding opportunities limited to historically black colleges and universities were also published in September 2020 and June 2021. However, that research was not sufficiently advanced to be included in this symposium.

Featured Symposium Articles

This symposium presents 10 new research articles on projects funded by HUD through the Cooperative Research in Housing Technologies grant competition. In addition to descriptions of their research and findings, each author opened their monographs by revisiting their rationale for proposing the effort. Specifically, the authors were asked to describe—

- Why HUD funding is required and how the resulting knowledge will help the Department and industry improve the quality and performance of housing.
- The significance of the work, including its relationship to past efforts and those proposed for the future. The authors were asked to clearly describe how their work builds on existing knowledge and how it would foster innovation in homebuilding in the future.
- How the effort will change the homebuilding process, including the broader impact expected, practical implications, and why the information will be accepted by relevant stakeholders.
- Anticipated changes to building codes, design processes, or construction that are expected to be necessary to support widespread use of the result of this effort.

Synopses of the 10 Research Articles

1. Christine Barbour and James Lyons of Newport Partners, LLC examined technical and regulatory solutions for effective air sealing of area separation walls in attached housing to reduce housing costs and increase efficiency, safety, and indoor air quality. Townhomes and duplexes represent some of the most-affordable forms of new housing options in the United States, yet the separation wall between adjacent dwelling units is a major problem area that is jeopardizing energy efficiency, fire safety, code compliance, and housing affordability. This article summarizes field and regulatory solutions to consistently design and construct cost-effective area separation walls and serves as an example of the need to harmonize codes through a holistic lens and adopt innovations to reduce complexity and maintain affordability. The results of this project give builders and municipalities a clearer understanding of these issues and enable them to apply balanced technical and regulatory solutions as the energy code landscape rapidly accelerates to meet climate change goals.
2. Jeff Carney, Ravi Srinivasan, Stephen Bender, Bill O'Dell, Ryan Sharston, Abdol Chini, and Forough Foroutan of the University of Florida developed prototype designs for rapid manufacture and placement of postdisaster housing. Advanced modular housing design (AMHD) addresses the design of housing that can be rapidly built in factories that can cope with future major events and become major community assets. The natural disasters considered in the development of the AMHD include hurricane-force winds, flooding, and storm surges. The attributes required for AMHD postdisaster housing include high structural strength, high levels of energy efficiency, energy self-sufficiency, and deconstructability. HUD support for the research has the potential to spur innovation across the manufactured and modular homebuilding industries to develop innovative solutions for postdisaster housing.

3. John W. van de Lindt of Colorado State University, Maria Koliou of Texas A&M University, and Pouria Bahmani of Washington State University designed and tested several generic connectors for use in cross-laminated timber (CLT) balloon-style construction. The research provides results that demonstrate and document a rational design procedure for CLT balloon-style construction for use in seismic regions of the United States. The effort will conclude with a U.S. code proposal that can be adopted by local jurisdictions and national-level provisions and design codes developed in coordination with a stakeholder-based expert panel.
4. John B. Peavey, Nay B. Shah, Chinedu Moneke, Kevin Kauffman, and Elina Thapa of Home Innovation Research Labs developed residential resilience guidelines for builders and developers. The research identified and converted the existing breadth of general ideas and policies on resilience to specific and actionable guidelines and criteria that can be understood and integrated into residential design and construction practices for both multifamily and single-family communities. The resulting resiliency framework may lead to the establishment of voluntary or incentivized above-code programs that are critical to fostering early market transformation.
5. Victor Braciszewski, Stet Sanborn, Justin Tholen, and Harshana Thimmanna of SmithGroup; Tyler Pullen and Carol Galante of the University of California, Berkeley, Terner Center for Housing Innovation; and Jamie Hiteshew of Factory_OS examined the integration of a heat pump water heating system to increase energy efficiency and reduce cost in modular construction. The authors provide an analysis of the potential for heat pump water heating systems in particular, due to the high proportion of typical building energy usage associated with water heating. To encourage further adoption, the research assessed the advantages of and the challenges to combining such systems with modular construction practices, with the goal of optimizing for cost efficiency, quality installation, and performance of this major energy-saving technique. Ideally, modular manufacturers beyond Factory_OS will adopt heat pump water heaters and homebuyers will insist on it.
6. Emanuel Levy, Jordan Dentz, and Yi-Jia Liao of the System Building Research Alliance reimagined and reengineered the design and fabrication of the heating, ventilating, and air-conditioning (HVAC) system in manufactured housing, with all components installed in the plant under the HUD quality control regime. This study explores two hardware integration and product configuration options that improve home performance and quality. It also explores changes to commercial arrangements, including the equipment distribution, inventory, and servicing necessary to align commercial interests that will ultimately benefit the homebuyer. Besides improvements to the quality of installation, the affordability of the HVAC system can be improved through bulk purchase of HVAC systems by home manufacturers.
7. John Peavey, Ed Hudson, and Zachary Summy of Home Innovation Research Labs investigated two critical construction issues related to three-dimensional concrete printing (3DCP). First, they identified barriers to adoption of 3DCP technology such as lack of building codes or standards, lack of design and construction guidance, and lack of technical expertise to implement the new technology. Second, the team evaluated the integration of 3DCP components—primarily

walls—with conventional building product components such as windows and doors, plumbing, electrical, and wall connections between roof and foundation. In addition, the article describes the results of qualitative research by home builders and contractors at jobsites and through a national survey to find the challenges and opportunities that will accelerate the adoption of 3DCP. The results of this research will inform builders that currently use traditional stick framing techniques on the pros and cons of building with 3DCP walls.

8. Isabelina Nahmens and Ondřej Labík of Louisiana State University; Alison Donovan, Kalee Whitehouse, Damon Lane, Desmond Kirwan, and Leslie Badger of VEIC; and Ankur Podder and Shanti Pless of National Renewable Energy Laboratory developed and implemented techniques for the installation of solar panels and battery storage (S+S) in modular housing at the factory. The team identified the potential barriers (e.g., first cost, permitting, utility interconnection, finished-module transportation, future battery replacement) and the value (e.g., resiliency benefits, opportunities for utilities, clean energy equity for affordable housing, new markets for modular factories) of incorporating S+S into factory-built housing. Through a case study and factory information modeling, the team analyzed the factory-installed solar plus storage approach, which resulted in an approximately 27 percent potential total cost reduction compared with on-site installation. Results from this project set forth a new strategy for resilient construction to all-electric zero-energy modular homes and redesign of resilient power systems from backup generators to S+S.
9. Mohammad Aghajani Delavar, Hao Chen, and Petros Sideris of Texas A&M Engineering Experiment Station describe their efforts to demonstrate, document, and validate a rational design procedure for 3D concrete printing residential construction, accounting for seismic loads; and to develop, in coordination with a stakeholder-based peer review panel, a best-practices document to serve as a building code proposal that can be adopted by local jurisdictions and national-level provisions and design codes. The article further describes large-scale testing of 3D concrete printed walls with and without integrated reinforced concrete elements, the development of design capacity equations, and a comprehensive seismic collapse assessment study of a set of 3D printed archetype buildings to demonstrate their margin against seismic collapse. The resulting building code proposal, if accepted, will facilitate widespread adoption of 3D concrete printing in seismic regions.
10. Nafisa Tabassum and Rifat Bulut of Oklahoma State University conducted a thorough examination of current state-of-the-art knowledge and recent developments in slab-on-ground foundations constructed over expansive soils. Expansive soils are soils that swell or shrink ground surface during times of wet and dry conditions. Degradation of a foundation through swell and shrink cycles can severely affect a home's resilience and long-term durability. Climate change has exacerbated the problem by increasing rainfall in some areas and by bringing rain to normally dry areas. Research results show that commonly used foundation design software might not account for the effects of climate change on expansive soils. The findings of this work could improve the resilience of slab-on-ground foundations to climate change if accepted by standards and code bodies that maintain these standards.

Acknowledgments

For their contributions to this symposium the guest editors thank the authors, reviewers who performed blind peer reviews of the manuscripts in a short timeframe, and the editorial staff of *Cityscape*. The guest editors are also indebted to their colleagues in the Affordable Housing Research and Technology Division for their continued support—especially Division Director Dr. Regina Gray.

The peer reviewers for this symposium were Dana Bres, Joshua Butzbaugh, Jay Crandell, Diana Fisler, Mike Hollar, Mike Lubliner, John Peavey, Tyler Pilet, Mark Reardon, Jagruti Rekhi, Alaina Stern, and Elina Thapa.

Guest Editors

Mike Blanford is a research engineer in the Affordable Housing Research and Technology Division of the Office of Policy Development and Research at the U.S. Department of Housing and Urban Development. Mike serves as program manager of the Cooperative Research in Housing Technologies program.

Kent Watkins is chairman of the American Academy of Housing and Sustainable Communities. Kent was an aide to Robert Weaver, the first HUD Secretary, and he has worked with all of the Secretaries and their principal staffs from that time. As vice president of development at Westinghouse Corporation's subsidiary, he also participated in the firm's Operation Breakthrough contracts for both site management and factory-built housing. Later, he worked with more than 600 housing and urban agencies on all aspects of housing and related urban functions (e.g., transportation, education, jobs, resident and consumer participation, land use planning, health, disaster planning, finance, IT). Today he continues his efforts to integrate intergovernmental silos and delivery systems into urban neighborhoods and to foster international urban technology transfer of information and products.

References

Hudson, Ed. 2022. Unpublished data. Home Innovation Research Labs.

Koebel, C. Theodore, Maria Papadakis, Ed Hudson, and Marilyn Cavell. 2004. *Diffusion of Innovation in the Residential Building Industry*. Washington, DC: U.S. Department of Housing and Urban Development.

Martin, Carlos, and Andrew McCoy. 2019. *Building Even Better Homes: Strategies for Promoting Innovation in Home Building*. Washington, DC: U.S. Department of Housing and Urban Development.

National Research Council of the National Academies of Sciences and Engineering (NRC). 2008. *Rebuilding the Research Capacity at HUD*. Washington, DC: National Academies Press.

———. 1985. *Experiences of Federal Agencies with Solar Energy Systems: Synopsis of a Workshop*. Washington, DC: The National Academies Press. <https://doi.org/10.17226/19318>.

———. 1969. *A Strategic Approach to Urban Research and Development: Social and Behavioral Science Considerations*. Washington, DC: National Academy of Sciences.

National Science and Technology Council (NSTC) Committee on Civilian Industrial Technology, Subcommittee on Construction and Building. 1995. *Construction and Building: Federal Research and Development in Support of the U.S. Construction Industry*. Washington, DC: National Institute of Standards and Technology.

U.S. Department of Housing and Urban Development (HUD). 2016. *PD&R: A Historical Investigation at (Almost) 50: A HUD 50th Anniversary Publication*. Washington, DC: U.S. Department of Housing and Urban Development Office of Policy Development and Research.

———. 1996. *Ninth Report to Congress on the Manufactured Housing Program, 1996*. Washington, DC: U.S. Department of Housing and Urban Development.

———. 1980. *Residential Solar Demonstration Program: Findings of the Passive Solar Residential Design Competition and Demonstration*. Washington, DC: U.S. Department of Housing and Urban Development. <https://www.huduser.gov/Publications/pdf/HUD%20-%2050813.pdf>.

———. 1976. *Solar Heating and Cooling Demonstration Program: A Descriptive Summary of HUD Cycle 2 Solar Residential Projects*. Washington, DC: U.S. Department of Housing and Urban Development. <https://www.huduser.gov/portal/Publications/pdf/HUD%20-%205682.pdf>.

Wilson, Barbara Brown. 2021. "East Austin Oaks: The Limits of Participatory Planning in the Space Age," *Journal of Planning History* 20 (1): 28–48.

Increasing Innovation and Affordability in Housing: A Case Study on Townhome Area Separation Walls

Christine Barbour

James Lyons

Newport Partners, LLC

Abstract

Consistently achieving cost-effective area separation walls (ASW) in townhomes that meet the fire protection requirements in the residential building code and air tightness provisions in the energy code can be a challenge for builders, architects, designers, trade contractors, and code officials. Townhome ASWs are complex and must serve several functions, including fire separation, limiting sound transmission, and limiting airflow. The typical townhome ASW is a 2-hour fire-rated gypsum assembly. Because townhomes are often a more affordable housing solution, cost is important. The energy code provisions reduce air leakage through the building envelope for energy and cost savings to the consumer and, at the same time, require additional steps to achieve and test reduced air leakage rates.

For cost-effective construction, builders need predictability and consistency. The fragmentation of the construction and inspection process with so many players with different roles means that the installation of any product or material may have unintended effects or consequences on the overall building performance. Historical examples, such as moisture accumulation within highly insulated walls or complications with attaching cladding over exterior foam insulation on walls, are often related to increases in one code that are not immediately reflected in other codes. In the case of ASWs, the gypsum assemblies are designed for fire protection. When the energy code is adopted, sealing the ASWs is needed to meet the air leakage requirements. This research demonstrates that air leakage is higher at the ASWs than the exterior walls on the end units, so ASWs must be air sealed to reach the air leakage requirements. Unless the air sealing material is part of the fire-rated gypsum assembly, a chance exists that the townhome will not pass the inspection.

Abstract (continued)

To meet the fire protection and energy code requirements, a builder might face issues that can impact construction costs, including additional inspections that affect project scheduling, different interpretations of ASW requirements by various jurisdictions, construction setbacks, delays in certificates of occupancy, and lost energy savings. With the Inflation Reduction Act of 2022 and efforts across the country to reduce building greenhouse gas emissions by adopting zero energy codes, plus the strong market for townhomes, the need for cost-effective, code compliant ASWs is likely to increase. This article summarizes field and regulatory solutions to consistently design and construct cost-effective ASWs and serves as an example of the need to harmonize codes through a holistic lens and adopt innovations to reduce complexity and maintain affordability.

Introduction

Townhome area separation walls (ASW) serve as a case study for larger issues related to innovation and affordability in the housing industry. Townhomes are an important part of the housing mix, especially when it comes to affordability. They provide living space and some outdoor space like single-family homes and often at a lower relative cost. With energy-efficient construction, townhomes are even more affordable to own and operate. Consistently achieving cost-effective ASWs in townhomes that meet the fire protection requirements in the residential building code and air tightness provisions in the energy code can be a challenge. ASWs must serve several functions, including fire separation, limiting sound transmission, and limiting airflow. It is complex to design, build, and code-approve ASW assemblies that clearly meet all these requirements. The challenge for builders is achieving consistently low air leakage rates while maintaining affordability.

Builders are responsible for managing townhome projects from blueprints to completed homes. They hire architects, designers, trade contractors, and hopefully energy raters or consultants. They procure the products and materials and coordinate the scheduling and sequencing of trade contractors and code inspections. On average, it takes 22 trade contractors to build a home (Emrath, 2015). A townhome has the added complexity of an ASW.

ASWs are typically 2-hour fire-rated assemblies designed and tested to meet this standard by gypsum manufacturers. They are commonly called gypsum shaftliner assemblies (exhibit 1). Shaftliner assemblies have advantages over concrete masonry units, because they create more usable space, have better sound attenuation, can be installed by the framing crew in the same sequence as building construction without the need for scaffolding, and have lower labor and material costs (Rodriguez, 2018). Several trade contractors are involved in the construction and air sealing of ASWs—framers, air sealing and insulation contractors, and drywallers—plus the energy rater.

Exhibit 1

Shaftliner Area Separation Wall



Example of a 2-hour fire-rated gypsum shaftliner assembly. Photo credit: Newport Partners.

Energy raters or consultants are a neutral third party sometimes hired by the builder to analyze construction plans and provide onsite inspections and use diagnostic testing to facilitate the inspection and demonstrate meeting the requirements of above-code energy efficiency programs. The energy rater looks at the home from the perspective of building science, or the “house as a system.” Energy raters can be important for quality control.

The code official follows and enforces building codes adopted by local jurisdictions or states to ensure the health and safety of future occupants, a process that can be just as fragmented as the construction process. Building codes, which include commercial, residential, fire, mechanical, plumbing, sanitation, and energy codes, are based on International Code Council (ICC) model codes in most states. They often have local amendments adopted by the state or the municipality. Townhome builders must not only adhere to several different codes, but they must also coordinate inspections throughout the construction process. Builders are required to have their building plans reviewed to get a permit. Then, several inspections are necessary—foundation, underground or slab, rough, and final inspections—prior to a certificate of occupancy.

Limited industry research or analysis of the ASW issue has been completed due to its diffuse nature. Previous U.S. Department of Energy (DOE) Building America efforts circa 2015–16 included an industry meeting that established the parameters of the issue. More recent efforts involve worst-case scenario assembly testing, resulting in updates that acknowledge the use of air leakage sealants (discussed further in this article). This effort to develop and publicly disseminate broader industry guidance on code barrier solutions and field innovation is only possible due to the support of the U.S. Department of Housing and Urban Development (HUD). HUD's support is vitally important, because this national-scale housing industry issue negatively affects affordability, energy efficiency, safety, indoor air quality and health, and the consistency of code compliance in townhomes.

With HUD's support, Newport Partners collaborated with a regional builder, a manufacturer, an energy rater, and an industry advisory committee to conduct field research, analyze regulatory barriers, and develop solutions for cost-effective ASWs that satisfy code requirements. The results of this project give builders and municipalities a clearer understanding of these issues and enable them to apply balanced technical and regulatory solutions, as the energy code landscape rapidly accelerates to meet climate change goals. It also provides solutions for builders working in multiple jurisdictions with no statewide code or states in which different requirements may be open to different interpretations.

The market impact of this effort is significant. According to a National Association of Home Builders (NAHB) analysis, townhome construction surged to 28 percent in 2021 compared with the previous year (Dietz, 2022). NAHB predicted positive long-term prospects for townhomes as homebuyers look for medium-density walkable neighborhoods, and first-time homebuyers need solutions in high-cost areas (Dietz, 2022). Improved clarity on technical and regulatory solutions to issues like ASWs can improve the likelihood of energy code adoption occurring at the state level to increase energy savings. With the introduction of the Inflation Reduction Act, significant funding will be available to encourage states and municipalities to adopt zero energy codes. This advancement will increase the pressure to harmonize codes from a building science perspective and adopt innovations while maintaining affordability.

Model Codes

For fire safety, the International Residential Code (IRC) has long included requirements for tested fire-rated wall assemblies between townhomes. The purpose of these tested assemblies is to prevent or slow the spread of fire between units. ASW is an industry term for a wall separating townhomes. They are also called double walls or common walls. The fire separation must be continuous from the foundation to the underside of the roof sheathing, and each unit must be structurally independent. Fire blocking and draft stopping are also part of the equation. Fire blocking is installed to form a barrier to resist the free passage of flames horizontally and vertically between floors and the top story and roof space. Draft stopping is installed at intervals to restrict air movement and impede the spread of flames.

With the International Energy Conservation Code (IECC), reducing air leakage through the building envelope is a major focus for energy savings. Forty-eight states, the District of Columbia, Puerto Rico, and the U.S. Virgin Islands have adopted some form of this model energy code (ICC,

2022). The 2012 version of the IECC, for the first time, introduced a mandatory whole-building air leakage test, with an air tightness requirement that was much more stringent than previous code editions. Prior to 2012, the IECC allowed either a visual inspection of air sealing details or a building envelope air leakage test. In addition, builders choosing the option of the air leakage test had only to meet a requirement of 7 air changes per hour at 50 pascals pressure, or 7 ACH50, a level that most of the industry could achieve without new strategies or technologies. In the 2012, 2015, and 2018 editions of the IECC, the residential provisions for climate zones 3 through 8, which cover roughly 90 percent of the United States, require that dwellings must be tested to demonstrate that air leakage is less than or equal to 3 ACH50 (exhibit 2).

Exhibit 2

International Energy Conservation Code (IECC) Climate Zone Map

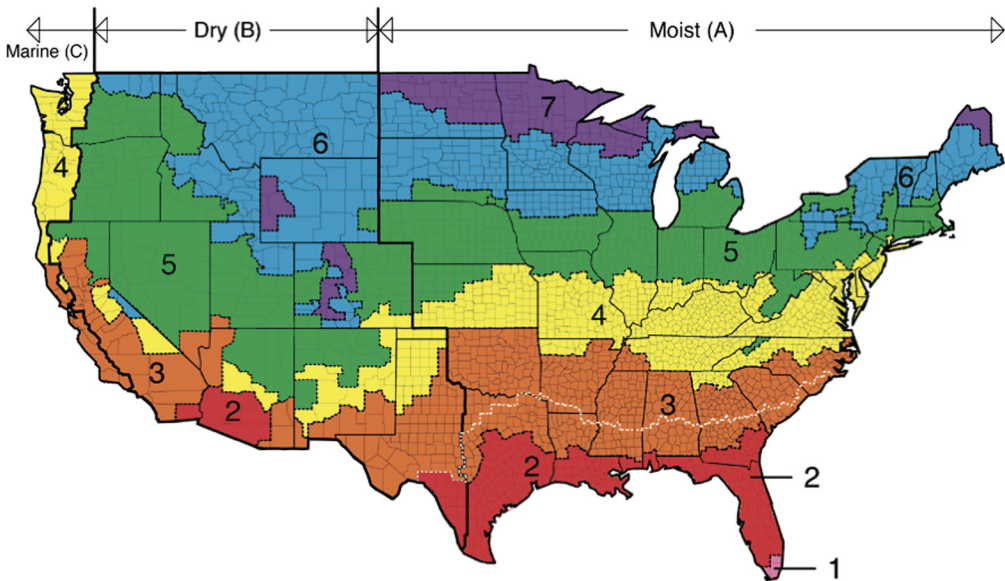

IECC Climate Zones

■ = 1 ■ = 2 ■ = 3 ■ = 4 ■ = 5 ■ = 6 ■ = 7

Source: Building America Solution Center, basc.pnnl.gov

The term *ACH50* is the air changes per hour—or how many times the air volume in a home turns over with fresh air, when the house is pressured to 50 pascals relative to outdoors. “A 50 pascal pressure is roughly equivalent to the pressure generated by a 20-mph wind blowing on the building from all directions” (The Energy Conservatory, 2017). One air change for a single-story, 2,000-square-foot home with 8-foot ceilings is 16,000 cubic feet of air, for example.

Blower door test results are used to demonstrate air leakage rates. The blower door test uses a large fan to elevate pressure within the home to 50 pascals and measures the flow rate at this pressure to allow the calculation of ACH50. It is also a diagnostic tool to find the leaks that need to be sealed.

Conceptually, this code requirement to establish a field-verified air-tightness specification for new homes makes sense. It should reduce air infiltration and save energy. At the same time, limiting air leakage between adjacent dwelling units, such as townhomes, improves fire safety, indoor air quality, and sound performance. Plus, field verification using the common blower door test gives the code official a clear pass or fail signal of compliance with this code requirement. This clear indicator helps to assure that the building will function as intended and is easier to enforce than other aspects of the energy code. In practice, however, a lack of clarity sometimes arises about which air sealants are allowed in the assembly. This lack of clarity can result in confusion, lost energy savings, inconsistent code enforcement across jurisdictions if no state code exists, construction delays, cost impacts, and delayed certificates of occupancy if issues were not caught early.

The model codes are updated through a rigorous process on a 3-year cycle. Engineers, architects, building scientists, manufacturers, building and trade association representatives, code experts, and other interested parties continually update building and energy codes—or push back against changes—based on evolving knowledge, climate issues, innovations, competitive forces, and cost impacts. As issues between codes arise, they are typically resolved in future code development cycles. Sometimes, however, issues arise that are not in direct conflict but create confusion during the integration of the house as a system.

Air-Sealing of Area Separation Walls that Modifies the Fire-Rated Assembly

ASW gypsum assemblies are constructed with two 1-inch thick, 24-inches wide gypsum shaftliner panels fitted between metal studs. The adjacent wood-framed walls on either side of the shaftliner panels are attached to the metal studs using aluminum breakaway clips. The clips help maintain ASW stability and ensure a minimum of three-fourths of an inch airspace gap between the gypsum shaftliner and the adjacent wood framing. The clips melt when exposed to high temperatures during a fire, allowing the affected wood-framed wall of the townhome to collapse and not spread to the next unit (exhibit 3).

Exhibit 3

Gypsum Shaftliner Assembly Drawing

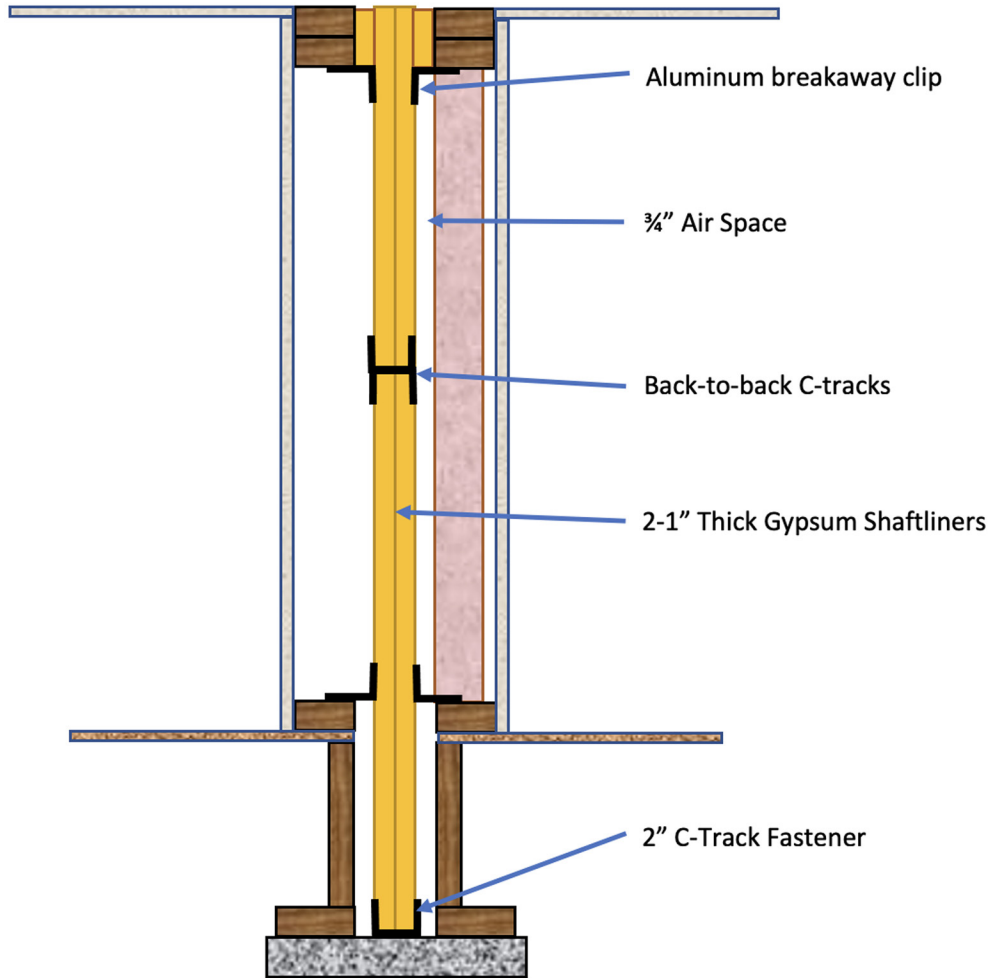

Design details for a gypsum shaftliner assembly include aluminum breakaway clips that melt when exposed to high temperatures during a fire, allowing the affected wood-framed wall of the townhome to collapse and not spread to the next unit.

Source: Newport Partners

Gypsum manufacturers fire-test assemblies with accredited laboratories to achieve fire-rated ASW designs. Several testing agencies provide third-party certification that a gypsum shaftliner assembly meets regulatory and market requirements. The fire-rated assemblies tested by Underwriters Laboratories (UL), for example, are numbered, and those numbers are associated with a proprietary assembly tested by a specific gypsum manufacturer. Proprietary shaftliner assemblies include United States Gypsum (U336), National Gypsum (U347), CertainTeed Gypsum (U366), Georgia-Pacific Gypsum (U373), and American Gypsum (375).

The core issue is that it is necessary to thoroughly air seal the entire building envelope to meet the IECC's ACH50 requirements, although the UL or other listed assemblies have not explicitly called out air-sealing materials until recently. This discrepancy has raised questions about which locations around an ASW can be air sealed and with which materials.

A significant amount of air leakage in a townhome occurs where the ASW meets the exterior walls, the ceiling to attic, the rim joist, penetrations, stairs, stairwells, and stairs connected to the garage. Generally, a lot of little gaps can add up to the issues seen with ASWs. To cost-effectively air seal around the ASW without going beyond what is explicitly permitted in the listed assembly, builders air seal ASWs with a wide variety of methods and materials to meet the energy code. Methods and materials applied in the field include picture framing the perimeter with spray foam, using fire-blocking sealant at all seams, adding strips of drywall to create blocking at air leakage points, using gaskets to close gaps between the ASW and framing, or variations and combinations of these methods. A possible implication of these efforts is an effect on the fire performance of a separation wall that has been modified for the purpose of air sealing. For example, in the case of a shaftliner assembly, the aluminum breakaway clips may be covered with an air-sealing material like spray polyurethane foam, and the air space called for in the rated assembly may be partly or fully filled with air-sealing materials that could theoretically affect the melting of the clips that break off in the event of a fire and prevent one dwelling's fire-damaged framing from pulling down the separation wall.

Lost Energy Savings and Inconsistent Code Enforcement

The enforcement of the 3 ACH50 specification can vary from one jurisdiction to the next and even from one code enforcement officer to the next. Anecdotes exist of blower door results close to 3 ACH50 being good enough at times. In other cases, code enforcement officers are more concerned with the fire code and may not pay close attention to blower door test results. Potential outcomes include homes with higher air leakage rates with permanent, built-in energy losses and higher energy costs. The higher air leakage can present performance issues such as indoor air quality problems as well. The authors estimate that a well air-sealed separation wall assembly, compared with the typical leakage levels seen in the field from noncomplying sites, results in energy savings of more than \$1,000 during 7 years in a moderate climate with significant heating and cooling.

Guarded blower door tests can be done on attached dwellings, in which multiple blower door systems pressurize the adjacent units so that the measured air leakage in the test dwelling is only flowing outdoors (and not to adjacent dwellings). However, even guarded blower door testing of this type has shown substantial leakage to the outdoors from the perimeter joints of typical ASWs. In fact, a 2015 DOE report concluded, "Even with the nominal elimination of unit-to-unit leakage [through guarded blower door testing], none of the [townhome] units reached the 3 ACH50 target. The end units were closest at 3.4–3.5 ACH50. The middle units reached 4.2–4.5 ACH50" (Ueno and Lstiburek, 2015). Guarded blower door tests are expensive and impractical, because work on all units within a building must stop to prepare and run the tests (exhibit 4).

Exhibit 4

Guarded Blower Door Tests with Pressurization Fan in Each Townhome Doorway



Guarded blower door testing, with a blower door on the doorway of each townhome, is expensive and impractical, because construction on the entire building must be temporarily halted. Photo credit: Newport Partners.

Construction Delays and Cost Impacts

The IECC's mandatory air leakage limit of 3 ACH50 is assessed based on a pass-or-fail diagnostic test that occurs at the end of construction. At this point in the construction cycle, the ability to improve the air-sealing of the building shell is severely limited, because most of the air leakage points are concealed. If a blower door test reveals a result of 4.5 ACH50, for example, a townhome will fail, the dwelling will not pass its final energy code inspection, and a certificate of occupancy cannot be granted. Builders, their contractors, and energy raters often attempt to air-seal anything that might reduce the air leakage through the shell, such as attic hatches or the dampers on bath exhaust fans. Retesting occurs, and gradually the ACH50 value may decrease to reach 3 ACH50. This arduous process consumes days in some cases, causing missed milestones with buyers, contractual problems, and ultimately costing builders hundreds or thousands of dollars. These challenges also put code enforcement officers under pressure to approve noncompliant buildings.

Area Separation Wall Field Evaluation

In 2019, Newport Partners convened an advisory committee comprising industry experts in construction innovations, codes, fire safety, and energy efficiency to provide guidance and input into the research design. Newport Partners worked with Thrive Home Builders and BUILDTank to conduct an ASW field evaluation in two buildings with a total 11 townhome units in Wheat Ridge, Colorado (exhibit 5). Wheat Ridge, a home rule municipality in Jefferson County, follows the 2018 I-codes and IECC (Colorado Energy Office, 2021). Wheat Ridge is a cold climate (IECC climate zone 5).

Exhibit 5

WestRidge Townhomes, Wheat Ridge, Colorado



WestRidge Townhomes by Thrive Home Builders in Wheat Ridge, Colorado, where the field evaluation took place. Photo credit: BUILDTank.

Thrive Home Builders uses gypsum shaftliner assemblies, a commonly used ASW described previously in this article. To meet energy code requirements, this assembly requires air sealing contractors to manually caulk and spray foam at points of air leakage that need additional labor, and the blower door test results may vary. The lack of predictability and increased labor costs impact affordability.

The field study evaluated two gypsum shaftliner assembly options for ASWs. The first option, building one, with six townhome units described as A through F, incorporated the builder's typical ASW approach with the addition of an innovative aerosolized sealant (exhibit 6). The comparative option, building two, with five townhome units described as A through E, incorporated an alternative blocking method plus the innovative aerosolized sealant (exhibit 7). The study evaluated which method resulted in more cost-effective, easier to construct ASWs, with consistent blower door test results.

Exhibit 6

Building One Layout

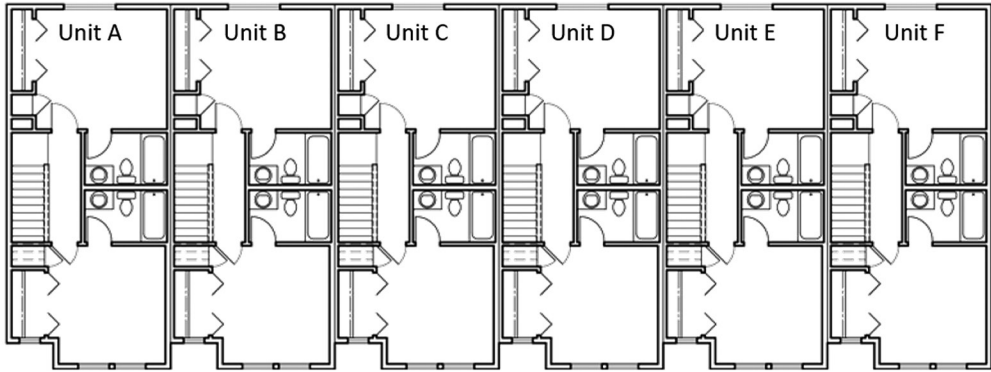

Source: BUILDTank

Exhibit 7

Building Two Layout

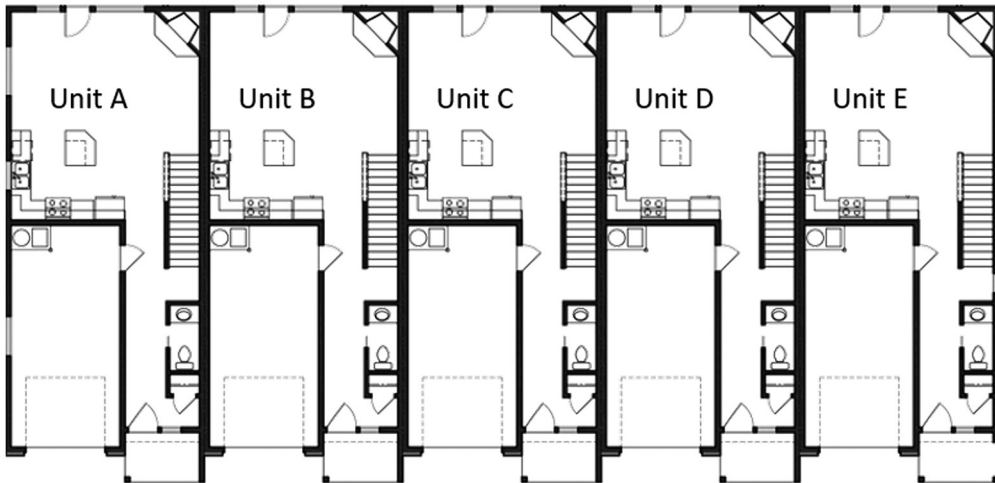

Source: BUILDTank

Air Sealing Innovation

The air sealing contractor prepared each townhome and applied the aerosolized sealant to achieve a specified air leakage rate. AeroBarrier, an aerosolized acrylic sealant, was pumped into the compartmentalized townhome unit after drywall installation to seal all openings less than one-half of an inch. Applying the aerosolized sealant took 3 to 5 hours per unit.

The process for applying AeroBarrier is as follows.

1. Prepare the house after drywall by temporarily covering all openings that are not meant to be air sealed (for example, bathroom fan grille, joint between window sashes, and so on), allowing the aerosolized sealant to air seal all openings less than one-half of an inch (exhibit 8).
2. Set up nozzles throughout the house.
3. Enter a specific energy performance goal into the computer control system and pressurize and seal with a modified blower door. The aerosol sealant accumulates in holes that leak air from the building and ultimately closes those holes. This process takes 1 to 2 hours.
4. Monitor the progress of the sealing on the computer.
5. Clean up and resume construction within 30 minutes, which is significantly less time than it takes for caulking to dry.

Exhibit 8

Preparation for AeroBarrier Aerosolized Sealant Application

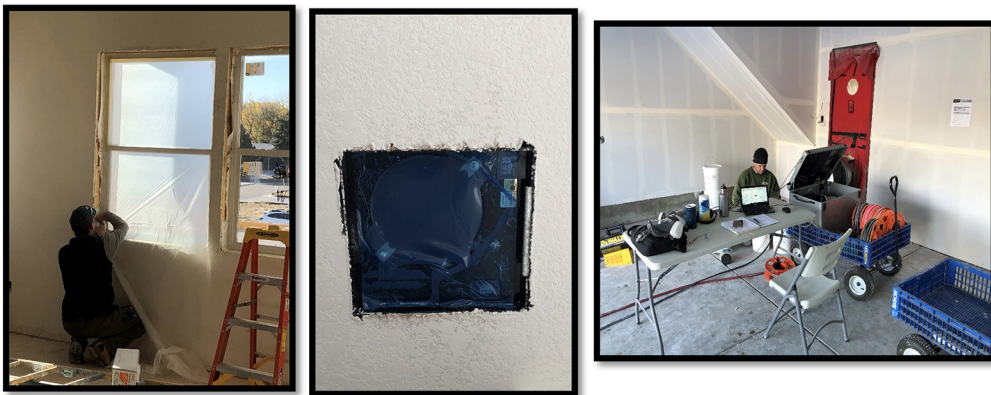

Temporary covering is placed over windows and ventilation fan. The plastic film does not cover the perimeter of the openings, allowing the product to seal those leakage points. The blower door is put in place and aerosolized sealant is applied, and the process is monitored on a computer. Photo credit: BUILDTank.

Test Results

The typical air leakage in townhomes prior to applying AeroBarrier ranged from 4 to 7 ACH50. As part of the AeroBarrier installation process, temporary coverings were added by taping off joints, such as window sashes where the accumulation of the aerosolized sealant was not intended. The result was additional temporary air sealing of the building shell down to an average of 1.7 ACH50. Exhibits 9 and 10 show these data in the rows labeled “blower door after AeroBarrier.” For this reason, air sealing is often conducted to an ACH50 rate less than what is necessary, because an increase in the blower door test value will present once the temporary coverings are removed, as can be seen in the leakage values shown in the exhibits the rows labeled “final code blower door.”

Exhibit 9

Building One Blower Door Test Results

BUILDING 1 Dwelling Unit	A	B	C	D	E	F
Blower Door Pre-AeroBarrier (some air sealing performed)	4.96 ACH50	5.97 ACH50	6.23 ACH50	4.81 ACH50	6.44 ACH50	3.76 ACH50
Blower Door After AeroBarrier (temporary air sealing)	1.64 ACH50	1.50 ACH50	1.88 ACH50	1.53 ACH50	1.67 ACH50	1.60 ACH50
Final Code Blower Door	2.19 ACH50	2.39 ACH50	2.75 ACH50	2.05 ACH50	2.34 ACH50	2.02 ACH50

ACH50 = air changes per hour at 50 pascals pressure.

Exhibit 10

Building 2 Blower Door Test Results

BUILDING 2 Dwelling Unit	A	B	C	D	E
Blower Door Pre-AeroBarrier (some air sealing performed)	4.63 ACH50	7.24 ACH50	6.43 ACH50	6.62 ACH50	5.10 ACH50
Blower Door After AeroBarrier (temporary air sealing)	1.83 ACH50	1.80 ACH50	1.90 ACH50	1.70 ACH50	1.59 ACH50
Final Code Blower Door	2.88 ACH50	3.00 ACH50	2.54 ACH50	2.64 ACH50	2.31 ACH50

ACH50 = air changes per hour at 50 pascals pressure.

After AeroBarrier was applied, all townhome units met the code requirements with final blower door tests between 2 and 3 ACH50. They could go lower, but it would cost more. This project was bid to ensure that the builder could reliably meet the 3 ACH50 energy code requirement, and this objective was achieved.

Applying AeroBarrier aerosolized sealant successfully minimizes worries about how well previous contractors sealed air gaps. It also reduces the need to caulk at electrical boxes, because the

AeroBarrier fills small gaps. Scheduling the trades remains important, because the builder needs to schedule two units per visit to avoid additional AeroBarrier fees. AeroBarrier serves as an example of a successful innovation, because its application provides consistently low air leakage rates and enables the builder to confidently meet energy code requirements.

Regulatory Barriers

After careful analysis of the 2012, 2015, 2018, and 2021 IRC, IBC, and IECC, Newport Partners identified regulatory barriers and developed strategies to create clearer paths to constructing and approving ASWs that satisfy both the fire protection requirements in the residential building code and air tightness provisions in the energy code.

Building Envelope Air Tightness Flexibility

The 2021 IECC allows for greater flexibility in compliance with the building envelope air-tightness testing requirements. For states and jurisdictions already using I-codes, adopting the 2021 IECC for its air tightness tradeoffs may provide the clearest solution, although this version of the IECC requires a higher overall efficiency level compared with prior IECC versions.

Although the visual inspection of air sealing details is still required, the 2021 IECC changed the air tightness test target to 5 ACH50 for all climate zones for buildings using one of two performance path options: Total Building Performance Option—R405 or Energy Rating Index Option—R406. A townhome builder who can consistently reach a 4 ACH50, for example, can adjust their design to make up for the energy that a leakier structure loses by adding efficiency elsewhere. In section R405, the most likely way builders can achieve equivalent energy performance is to add building envelope insulation or better windows. Section R406 uses an Energy Rating Index, defined by Residential Energy Services Network and ICC, as the energy target for the proposed building. This path offers significant flexibility beyond section R405. Heating, cooling, water heating, ventilation, lighting, and other building efficiency measures are all accounted for using the Energy Rating Index. Again, the townhome builder who can consistently reach 4 ACH50, or even 5 ACH50, can use higher efficiency mechanical equipment and achieve the required Energy Rating Index.

This approach offers added flexibility for townhome builders in IECC climate zones 3 through 8 who can achieve 5 ACH50 or lower using allowable and repeatable air sealing strategies. Many builders already use R405 for compliance and hire an energy rater to model their homes as part of this compliance strategy.

Compartmentalization

The 2021 IECC also allows for the use of a compartmentalization test to evaluate the air leakage of dwellings. It allows for a leakage level of 0.30 cubic feet per minute (CFM) per square foot of enclosure area or lower when testing attached single-family or multifamily dwelling units. CFM50 is the amount of air flow through leakage at gaps, joints, and so on, when the dwelling is being pressurized by a fan to a level of 50 pascals (a unit of pressure). The 0.30 CFM50 upper limit is also allowed for any building or dwelling unit smaller than 1,500 square feet. This alternative to

the ACH50 measurement is easier to reach and requires less air sealing compared with the ACH50 target. The air changes per hour metric normalizes air leakage based on the dwelling's volume. The compartmentalization metric normalizes leakage based on the surface area of the enclosed space, which includes all six sides of the dwelling and the ASW (on one or both sides). This flexibility may be enough to allow a home that could not pass by volume to pass using the new test.

Add Air Tightness Tradeoffs

When adopting a previous version of the IECC, municipalities can consider amending it to add language from the 2021 IECC to add air leakage flexibility. Maryland serves as a model for providing flexibility by meeting a whole house target for the same overall energy savings. When Maryland adopted the 2018 IECC, the state also adopted amendments to the code that were similar to the 2021 IECC language (State of Maryland, 2019). Maryland includes the 3 ACH50 requirement in the prescriptive path, with an air tightness target of 5 ACH50 or lower for a performance path. This requirement allows for builders using either section R405 or R406 for compliance to have a building air tightness level as high as 5 ACH50 if they add greater efficiency in other areas to offset the higher leakage rate.

Redefine the Area

During its adoption of the 2018 IRC, Denver, Colorado amended section 302.2.2 to redefine the area covered by the common wall for townhomes. In the IRC, the common wall is required to extend to the exterior sheathing of the exterior wall. However, Denver added an exception, allowing the common wall to extend to the interior of the edge of the exterior wall. The cavity between that edge and the exterior sheathing must be filled with wood studs. This amendment changes the defined area of the tested common wall so that it no longer includes the exterior wall. This change allows for adding air sealing measures at the intersection of the common wall and the exterior wall. Using air-sealing materials not included in the rated assembly at this point will not be an issue, because it is no longer part of the common wall (City of Denver, 2020).

The 2021 IRC also includes this concept in new language added to section R302.2.2. It defines the common wall as extending to the exterior sheathing of framed walls or to the inside of nonframed walls. An exception allows for the common wall to extend to the interior of the exterior wall if the framed cavity is filled with nominal 2-inch wood studs.

Amending the 2018 IRC, or previous editions using the Denver exception or the 2021 IRC, allows air sealing at a common point of air leakage between townhomes. This minor code amendment does not require additional testing. This solution allows for some air sealing without any effect on the common wall fire rating. The intersection of the common wall and the exterior wall is a point of significant air leakage, but it is not the only point of leakage. It is possible that air leakage could be reduced using this option, and townhomes that are close to passing the ACH50 requirement would then meet the requirement.

Amend the Code with Additional Materials

The primary regulatory barrier is that air-sealing materials are not detailed or included during the required American Society for Testing and Materials (ASTM) E119 or UL 263 testing of the assembly. Therefore, adding any air sealing material to pass the building envelope air tightness test, especially for interior townhome units, has the potential to invalidate the assembly. To resolve this issue, IRC sections R302.2.1 and R302.2.2 can be amended to specifically allow the addition of fire-rated foams and caulks to assemblies. In this way, the code is not altering the ASTM E119 or UL 263 testing, but merely allowing additional materials to be added to the tested wall.

Test a Broad Class of Materials

Additional testing has always been a solution to show compliance with any wall assembly using any air sealing material if it passes ASTM and UL tests. Testing is expensive and time consuming, and with nonproprietary assemblies, no organization may be available to pay for that testing. Rather than testing proprietary sealants in specific assemblies, another approach is to test a broad class of commonly used air-sealing materials to determine if they could be added to all rated assemblies without affecting the fire rating of the wall. This approach requires interpretation from ASTM and UL organizations and testing through an approved laboratory. The benefit is that it could give builders a universal solution without code changes or differences across jurisdictions resulting in more consistency with the potential for lower costs.

Additional Testing of Individual UL Assemblies with Specific Sealants

A recent industry effort led to updating UL assemblies that now call out the use of specific sealants. National Gypsum (U347), Georgia-Pacific Gypsum (U373), and American Gypsum (U375) specifically allow Dupont GREAT STUFF™ Gaps & Cracks, GREAT STUFF PRO™ Gaps & Cracks, and GREAT STUFF PRO™ Window & Door, as well as HandiFoam® Fireblock, HandiFoam® Fireblock West, and Fast Foam Fireblock by ICP Adhesives and Sealants. These sealants are optional but are allowed in the three-fourths of an inch perimeter gap and in the shaftliner. CertainTeed Gypsum (U366) allows the same sealants and locations plus latex sealant in specific locations in addition to Knauf ECOSEAL™ Plus. This testing was privately funded. Although the approvals apply only to the specific listed assemblies, they cover the most commonly used gypsum shaftliner ASW assemblies.

Recommendations

This article outlines a field evaluation of an innovation to improve air sealing of a gypsum shaftliner ASW and explores regulatory solutions for industrywide effect. The best regulatory solutions are enacted at a level that will be broadly accepted, such as at the ICC level. Any jurisdiction adopting the 2021 ICC codes will automatically have access to the flexibility in air tightness requirements described in that code. For many jurisdictions, adopting the newest codes may take time, so adopting amendments to the code may be a more viable option. Including approved air-sealing

materials in assemblies is another solution that is now available for several listed ASWs. For production builders working in multiple jurisdictions with different codes, adopting an innovative field solution may be the quickest strategy for maintaining townhome affordability.

Broad-scale solutions to support innovation and maintain housing affordability include creating an interagency collaborative—for example, HUD, DOE, and the U.S. Environmental Protection Agency—to sponsor a building science-based code review every 3 years and screen for potential issues, particularly for attached and multifamily homes. Such collaboration could identify and proactively address disconnects between evolving codes that affect constructability, building performance, or code enforceability. Groups like National Fire Protection Agency, American Wood Council, Air Conditioning Contractors of America, NAHB, and others could participate in the discussion. Another recommendation is to monitor hotlines and chat rooms for early identification of field issues. Federal and state governments should continue to train stakeholder groups on basic building science and the most recently adopted codes, as well as conduct field evaluations to test and support the adoption of innovations that reduce complexity and fragmentation and make housing more affordable

Acknowledgments

The financial support provided by HUD for this research under grant number H-21684 CA is gratefully acknowledged. Further, the authors thank Mike Blanford for managing and coordinating this work on HUD's behalf. Finally, the authors thank the editors and reviewers for their helpful comments.

The authors are grateful to Thrive Home Builders for their continued industry leadership and Robby Schwarz at BUILDTank for being the boots on the ground for the field evaluation. The authors also gratefully acknowledge the advisory committee for guiding the research and their participation in the roundtable: Amanda Kimball, Fire Protection Research Foundation; Kelly Brooks, West Metro Fire Protection District; Karen Carpenter, Southwest Research Institute; Miles Haber, Monument Construction; Nathan Kahre, EnergyLogic; George Martin, Howard County, Maryland; Shaunna Mazingo, The Mazingo Code Group LLC; Steve Myers, Town of Clifton Park, New York; Barry Reid, Georgia-Pacific Gypsum; Robby Schwarz, BUILDTank; Steve Van Note, International Code Council; and Luke Woods and Kevin Hyland, Underwriters Laboratories.

Joe Nebbia, the codes specialist at Newport Partners, and Matt Evans, the field research manager, made significant contributions to this research.

Authors

James Lyons is a project manager at Newport Partners. Christine Barbour is responsible for facilitating and communicating the results of this research at Newport Partners.

References

- City of Denver. 2020. Amendments to the Building and Fire Code for the City and County of Denver. https://www.denvergov.org/content/dam/denvergov/Portals/696/documents/Denver_Building_Code/2019-code-update/2019_final_amendments.pdf.
- Colorado Energy Office. 2021. Building Energy Codes. <https://energyoffice.colorado.gov/climate-energy/energy-policy/building-energy-codes>.
- Dietz, Robert. 2022. "Townhouse Construction Surged in 2021," National Association of Home Builders Eye on Housing blog, February 18. <https://eyeonhousing.org/2022/02/townhouse-construction-surged-in-2021/>.
- Emrath, Paul. 2015. "It Takes 22 Subcontractors to Build the Average Home," National Association of Home Builders Eye on Housing blog, September 3. <https://eyeonhousing.org/2015/09/it-takes-22-subcontractors-to-build-theaverage-home/>.
- The Energy Conservatory. 2017. Model 3: Minneapolis Blower Door. Minneapolis, MN: The Energy Conservatory. <https://energyconservatory.com/wp-content/uploads/2017/08/Test-Results-and-Sample-Test-Forms-Guide-.pdf>.
- International Code Council. 2021. International Building Code (IBC). Country Club Hills, IL/USA: International Code Council, Inc. <https://codes.iccsafe.org>.
- . 2021. International Energy Conservation Code (IECC). Country Club Hills, IL/USA: International Code Council, Inc. <https://codes.iccsafe.org>.
- . 2021. International Residential Code (IRC). Country Club Hills, IL/USA: International Code Council, Inc. <https://codes.iccsafe.org>.
- . 2018. International Building Code (IBC). Country Club Hills, IL/USA: International Code Council, Inc. <https://codes.iccsafe.org>.
- . 2018. International Energy Conservation Code (IECC). Country Club Hills, IL/USA: International Code Council, Inc. <https://codes.iccsafe.org>.
- . 2018. International Residential Code (IRC). Country Club Hills, IL/USA: International Code Council, Inc. <https://codes.iccsafe.org>.
- . 2015. International Building Code (IBC). Country Club Hills, IL/USA: International Code Council, Inc. <https://codes.iccsafe.org>.
- . 2015. International Energy Conservation Code (IECC). Country Club Hills, IL /USA: International Code Council, Inc. <https://codes.iccsafe.org>.
- . 2015. International Residential Code (IRC). Country Club Hills, IL/USA: International Code Council, Inc. <https://codes.iccsafe.org>.

———. 2012. International Building Code (IBC). Country Club Hills, IL/USA: International Code Council, Inc. <https://codes.iccsafe.org>.

———. 2012. International Energy Conservation Code (IECC). Country Club Hills, IL/USA: International Code Council, Inc. <https://codes.iccsafe.org>.

———. 2012. International Residential Code (IRC). Country Club Hills, IL/USA: International Code Council, Inc. <https://codes.iccsafe.org>.

Rodriguez, Juan. 2018. “Gypsum Area Separation Walls Townhouse Construction.” Liveabout.com. <https://www.liveabout.com/fire-protection-gypsum-separation-walls-844836>.

State of Maryland. 2019. *Maryland Register* 46 (6): 337–356.

Ueno, Kohta, and Joseph W. Lstiburek. 2015. *Field Testing of Compartmentalization Methods for Multifamily Construction*. U.S. Department of Energy. <https://www.nrel.gov/docs/fy15osti/63226.pdf>.

Additional Reading

Lstiburek, Joseph. 2006. *BSD-144: Increasing the Durability of Building Constructions*. Building Science Corporation. <https://www.buildingscience.com/documents/digests/bsd-144-increasing-the-durability-of-building-constructions>.

Martín, Carlos, and Andrew McCoy. 2019. *Building Even Better Homes: Strategies for Promoting Innovation in Home Building*. Washington, DC: U.S. Department of Housing and Urban Development.

U.S. Department of Energy (DOE). 2022. Status of State Energy Code Adoption—Residential. <https://www.energycodes.gov/status/residential>.

Advanced Modular Housing Design: Developing the CORE+

Jeff Carney
Ravi Srinivasan
Stephen Bender
Bill O'Dell
Ryan Sharston
Abdol Chini
Forough Foroutan
University of Florida

Abstract

The U.S. housing industry faces three primary challenges that this project addresses—rapid deployment of housing after a disaster, energy efficiency and performance, and affordability of housing. This article will demonstrate the results of a multidisciplinary research project funded by the U.S. Department of Housing and Urban Development (HUD) that developed an advanced modular housing design called CORE+, which provides new housing opportunities for communities facing increased risk from environmental hazards.

CORE+ combines three distinct modular units—CORE, SPACE, and DWELL—into a variety of spatial configurations based on user needs. Deployment of the dwelling begins with the installation of the 160-square-foot CORE unit, followed by the 193-square-foot SPACE addition, and finally, with the 794-square-foot DWELL unit. The CORE+ is deployed in the immediate aftermath of a disaster to provide minimal shelter. As components are added, CORE+ remains on site as an affordable and high-efficiency 1,200-square-foot, three-bedroom, two-bath home.

The research team included individuals with expertise in architectural design, building energy modeling, life-cycle economics, and affordable housing policy. Three design charrettes gathered input from local architects and housing manufacturers to inform the CORE+ design. The design was further refined through a fourth community workshop in hurricane-damaged North Port St. Joe, Florida, which revealed design challenges and opportunities for improvement through stakeholder feedback.

This project aimed to develop a roadmap to enable the modular housing industry to design post-disaster housing for rapid deployment, efficiency, and long-term resilience. By working with partners—including professional architects, industrial manufactured and modular home builders, and community stakeholders—the project aimed not only to design a new modular home but also to test its feasibility, cost-effectiveness, and functionality through the design process.

Introduction

Millions of Americans may have to relocate or face sudden displacement as a direct result of climate change and related disasters (Wamsler, 2010). In the Southeastern United States, more intense and frequent hurricanes are predicted for coastal areas, increasing the risk to coastal communities. The provision of safe and affordable housing is already an urgent challenge across the United States. Disasters exacerbate the lack of supply and cost of construction and can cause substantial long-term damage to communities. Advanced modular housing offers potential solutions to alleviate extreme shortages of housing stock, because it can be created with greater quality, accuracy, safety, speed, affordability, sustainability, and more inherent resilience than its site-built competitors (Gunawardena et al., 2014). Through a HUD grant, the Advanced Modular Housing Design CORE+ project addresses this challenge. HUD's support for this research has the potential to spur innovation across the massive manufactured and modular homebuilding industries.

The University of Florida team incorporated six faculty members from the School of Architecture and Rinker School of Construction Management that includes architects, city planners, engineers, and construction managers. The three working groups were based on architectural design, energy efficiency, and affordability. External industry partners included LG Electronics, Clayton Homes, Palm Harbor Homes, and Jacobsen Homes. Six homeowners in the community of North Port St. Joe, Florida, participated in a multiday workshop to test the design with community input.

Substantial speculation exists regarding the potential of modular housing to address significant challenges facing American communities. Architectural researchers have investigated—and in many cases tested—modular constructed housing, including factory-built, three-dimensional printed, rapidly delivered post-disaster, or tiny homes. However, these innovations continue to fail to change the industry, and traditional stick-built housing still dominates homebuilding. Many research projects fail in bridging between innovation and current industry best practices, leading to unbuildable or prohibitively expensive products. The significance of this project is not the novelty of modularity but the integration of post-disaster, hyper-efficiency, and affordability through the careful attention to industry input.

Rapid deployment, energy efficiency, and affordability are three major issues that the U.S. housing industry must address in vulnerable environments to overcome growing risks from disaster, rebuilding, and insurance costs. The results of this research will demonstrate a nexus between speed, efficiency, and affordability only achievable through modular construction. On top of meeting performance criteria, the project also addresses lingering concerns over stakeholder acceptance of modular housing and building codes that can impede its compliance. Through a series of workshops culminating in a stakeholder workshop in Port St. Joe, Florida, the designers worked with stakeholders (homeowners and city officials) to hone a process for customization that will lead to greater acceptance.

Domains of Research

The project's main objective was to develop a post-disaster, modular, single-family housing unit. Developed primarily in response to disasters and climate conditions of the Southeastern United

States, the project focused on the threats of hurricane-force winds, floods, storm surges, high heat, and demand for air-conditioning. High levels of energy efficiency, the capacity for energy self-sufficiency, suitable structural strength, and construction flexibility (for example, disassembly and reassembly) were considered necessary qualities for the design of post-disaster housing. The project focused on resiliency, sustainability, and affordability as the primary drivers of the design.

Resilience

Resilience is a concept that has its roots in ecology, but it has had a considerably broader effect (Holling, 1973). Since the mid-1990s, it has been used to investigate how humans and the environment interact (Mamouni Limnios et al., 2014). The term is applied to a range of topics, including physical security, business continuity, emergency planning, hazard mitigation, and the ability of the built environment (for example, facilities, transportation systems, and utilities) to resist and rapidly recover from disruptive events (McAllister, 2016). The ability of a system to absorb disturbance and reorganize—while going through change and maintaining basically the same function, structure, and identity—is known as resilience (Walker et al., 2004).

Sustainability

In the context of buildings, *sustainability* refers to the capacity to reduce the environmental impact via material choice and energy efficiency, as well as to enhance occupant comfort by using ideal lighting, ambient temperature, and enhanced ventilation (Santillo, 2007). Energy costs can be significantly decreased, carbon emissions can be reduced, and passively constructed, low-energy housing that is outfitted with renewable energy generating and storage technology may help make homes more energy and self-sufficient during longer-term power outages. In addition, waste may be reduced and building components recovered for reuse or recycling during demolition if building materials are selected with their full lifecycle considered (Brown et al., 1987).

Affordability

Regarding housing, the term *affordability* refers to the price of a shelter in relation to the buyer's financial resources (Hancock, 1993). When housing expenditures (including utilities) account for less than 30 percent of the area median income, the home is deemed affordable (HUD, n.d.). In Florida and much of the South along the Gulf Coast, an expanding population has outpaced the number of reasonably priced single-family homes, particularly to those with lower incomes. Cost-burdened families are paying more than 40 percent of their income on housing and account for more than 1.4 million people with earnings less than 60 percent of the annual median income in the state of Florida alone (Shimberg, 2020).

History of Hurricane Disasters and Post-Disaster Responses

Property and other infrastructure in U.S. coastal areas are increasingly in danger due to weather events like large storm occurrences. Hurricane-related floods and storm surges are among the most devastating natural and severe weather-related disasters affecting communities in the United States, particularly in the Southeast. This research focused on zones 1, 2, and 3 on the American Society of Heating, Refrigerating, and Air-Conditioning Engineers' climatic zone map (DOE, 2015).

Approximately 500 tropical or subtropical cyclones have made landfall in Florida, the most notable of which were Hurricanes Andrew in 1992, Irma in 2017, and Michael in 2018 (NOAA, 2022). The most active decade was the 1990s for the United States, with 31 storms having an impact.

Project Methodology

The project's main objective was to create a new kind of post-disaster housing that could address the growing scope and frequency of environmental disasters and extreme weather events that have become more frequent as a result of climate change (Phillips et al., 2017). The design process focuses on three distinct, but interrelated, research goals, titled—resource, efficiency, and resilience (exhibit 1). These goals serve as design objectives and as a basis for a set of quantitative indicators that can be used to evaluate the CORE+'s efficacy in relation to its goals and to observe potential tradeoffs.

Exhibit 1

Three Research Aims with Measurable Objectives that Are Balanced Through the Design Process

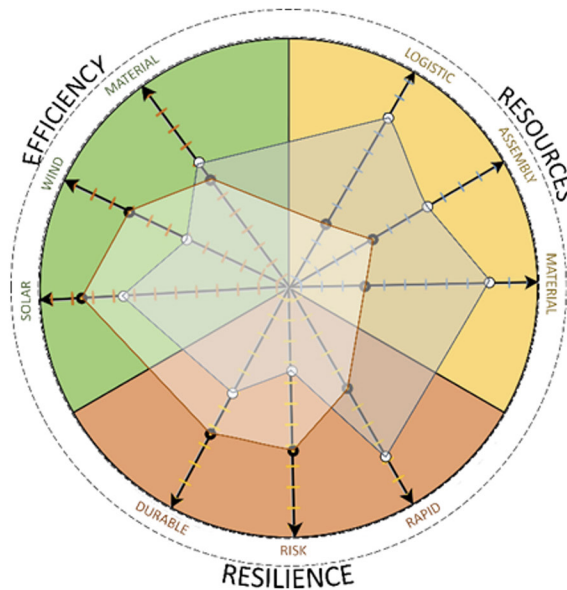

Source: University of Florida project team

Three interconnected and supplementary research strategies are at play in this investigation. In the first step, the team conducted case studies of evaluating several manufactured modular housing projects, taking a close look at the responsiveness, sustainability, and equality. Case studies provided the basis for a collaboration between academics and industry experts to advance the design of prefabricated modular housing. The initial design was also influenced by the rough specifications of the HUD model home. Although the CORE+ model was not constrained by this design, it did provide a rough scale and expectation of mobility and affordability that drives the HUD house.

Second, design charrettes allowed for the incorporation of industry and professional perspectives into the design process. Three topic charrettes were conducted as part of the project. The initial charrette concentrated on learning about the characteristics of the target consumer for CORE+ and pinpointing potential sites. Because the CORE+'s user is not limited to the individual or family who occupies the building but can also be influenced by the site, the conditions of occupation, and the tenure duration, the second charrette conducted a series of scenario exercises with mortgage and lending experts to investigate the CORE+'s varied user demands. Technology and energy efficiency professionals and fabricators were invited to participate in the third charrette to focus on the technical building systems being developed for the project.

Near the end of the project, the North Port St. Joe Project Area Coalition and Florida Agricultural and Mechanical (A&M) University collaborated with the University of Florida team, as well as the project team's collaborators at the Florida Resilient Cities program to host the last charrette as a public workshop. The goals of the workshop were to test the CORE+ design with real community demands for housing that is affordable, swiftly built, resilient, and energy efficient. The CORE+ was used through this workshop to plan, define, and cost model homes for six community-recommended locations. The workshop took place during a 3-week timespan, which allowed for significant refinement to the designs.

Architecture and Design Methodology

To produce rapidly deployable, resilient, energy efficient, and affordable housing for people who live in disaster-prone regions of the Southeastern United States, the project team based their research and design approach on a balance between the efficiencies of mass production in a factory setting and mass customization informed by clients and site conditions to achieve these goals (Larsen et al., 2019). Modular homes may be built in advance and delivered from less-hazardous areas to the areas most affected by natural disasters (Gunawardena et al., 2014). Although mass production is by definition "generic," the application of modular housing should be informed by regional and microclimatic conditions, specific siting requirements (such as coastal flood risks), individual client stylistic and spatial preferences, budget constraints and financing methods, local building controls, and the inevitable adaptations desired by families. Mass customization makes it possible to demonstrate the advantages of both bulk manufacturing and personalized design.

The research and design project resulted in the CORE+ modular house. It incorporates three different modules—the CORE, the SPACE, and the DWELL—all are built using modular factory building techniques (exhibit 2). Depending on the buyer's location, price, and timeline, these three modules may be put together in a broad range of combinations to create a variety of residence types. CORE+ is a set of interrelated modules, each of which fulfills a specific and vital function in the rapid restoration of safe, low-cost housing for long-term occupation in the aftermath of a disaster.

Exhibit 2

Distinct Modules that Accomplish Three Primary Functions of Housing: CORE+SPACE+DWELL

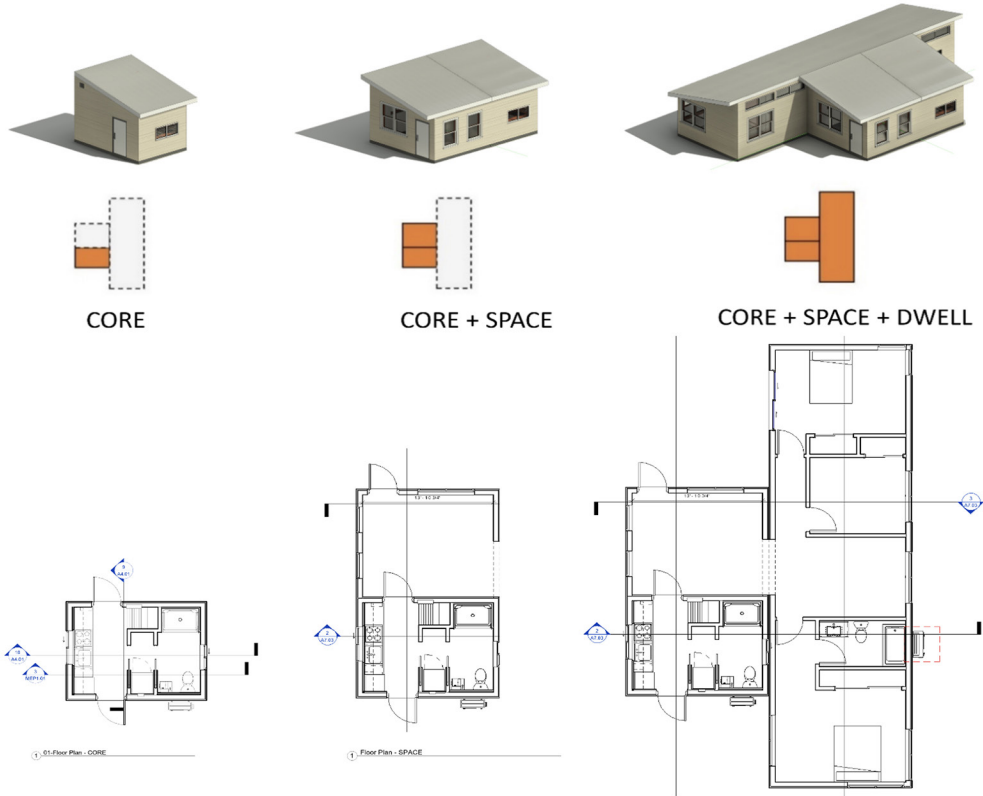

Source: University of Florida project team

CORE would be delivered to the disaster site within days. If the property is not yet ready, it may be stored temporarily in a parking lot or similar location. The unit, as exhibit 2 shows, is the substantial, storm-resistant “heart” of the whole construction, providing essential living amenities, such as a kitchen, bathroom, laundry room, and sleeping loft. The Core’s construction is structurally robust, and it will provide maximum protection against future storms for its inhabitants. This would allow for deployment in high-risk areas such as the Florida Keys. CORE is a rigid (self-supporting) and hardened construction that offers storm protection and foundation flexibility, even to the extent that it may be created and anchored temporarily. The CORE consists of a light gauge metal frame with sheathing and closed-cell foam insulation, constructed as a rigid assembly and shipped in bulk for quick installation.

SPACE is the second supplementary module and provides a space that may be used as a den, sleeping porch, or full bedroom. It is designed to be versatile, and homeowners are encouraged to expand on and alter the structure to suit their own requirements. This unit may be installed with the CORE unit, or it can be added afterward to give extra room. It is semi-rigid and requires additional foundational support.

DWELL is the third and final modular component. It enhances the size of the modular building by adding three bedrooms and an extra bathroom. Due to its conventional sizing for truck transportation, the unit's expenses are kept low even though CORE+ provides 1200 SF of living area.

Material Selection

The modular construction sector has expanded its range of materials, innovated the product sourcing, designed new production techniques, and experimented with logistics and the supply chain from beginning to finish. These advances in building materials and fabrication techniques were instrumental in the conceptual development of the CORE+ design. At the same time, the team's industry partners brought substantial experience in traditional construction and factory assembly techniques. The resulting design attempts to bridge traditional construction with an infusion of contemporary materials that are sustainable, robust, and efficient.

Energy Efficiency

The goal of the CORE+ project is a hyper-energy-efficient building that can be outfitted with cutting-edge systems and renewable energy technologies. However, the efficiency of the structure starts simply with the orientations of a CORE+ unit on site. As a modular unit, there is little control over orientation. Instead, the fenestration ratio of the building was tuned for the lowest possible energy use in any orientation. Additional tuning available through the process of project development would control energy consumption by shielding the south and east-west facades with a mix of horizontal and vertical shading devices is possible. This project employs a variety of passive design solutions to reduce the need for energy-intensive mechanical and utility systems in the building's design and construction (exhibit 3).

Exhibit 3

Passive Design Strategies



This project has, on average, 30% fenestration ratio for all facades to provide daylight in all seasons and sunlight in cold seasons. The project also has designed pitched roofs to shed rain and greater reflection of solar radiation, and can be extended to protect entries, porches, verandas, and other outdoor work areas.

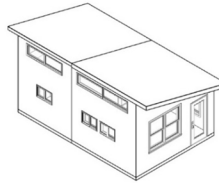

Operable clerestory windows will enhance the effect of "stack ventilation" by allowing the warmer air to leave the space at the higher elevation, which in turn, induces the admission of cooler air through the windows at the lower elevation.

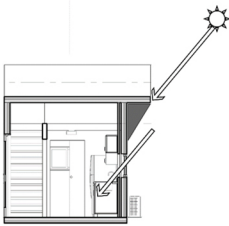

To avoid excessive solar radiation, south facing facades are equipped with overhang. The design also uses light colored building materials and cool roofs (with high emissivity) to minimize conducted heat gain.



The design provides double pane high performance glazing (Low-E) on west, north, and east, but clear on south for maximum passive solar gain.

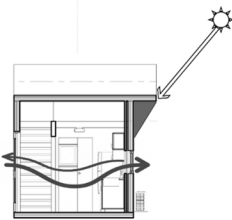

In addition to overhang, having windows facing each other across the space will provide an ample opportunity for cross ventilation, which can significantly lower building cooling demands when outside temperature is relatively low.



The design incorporates screened porches and patios that reduce the building's cooling requirements when the outdoor temperature is relatively high.

Source: University of Florida project team

Resilience

The CORE+ design meets or exceeds all of Florida's building code requirements for wind loading, passive heating and cooling strategies, and systems to mitigate extended power failures. The design includes an affordable piling system that allows for increased home elevation at multiple levels to fit the needs of the site. These technical solutions are built into the project from the start and are required or added according to the project's risk profile. Many of these decisions will be determined during the site selection phase of the project when a chosen home configuration is applied to a specific location. Greater resilience to future risk not only better prepares occupants for future disasters, but also builds a community asset that gains value with time. CORE+ design can contribute to the long-term value of a community, with durability in material, structure, and design that results in longevity that returns equity to the homeowner.

CORE+ Assembly and Manufacturing Process

Three dwelling units—the CORE, SPACE, and DWELL—were created as the primary building blocks of the CORE+ model. These modules may be put together to suit a buyer’s disaster needs, site requirements, budget, and family size. Following a disaster, homeowners recover their homes in four broad phases during disaster recovery (exhibit 4).

Exhibit 4

Site, Select, Balance—The Process of Selection and Assembly of CORE+

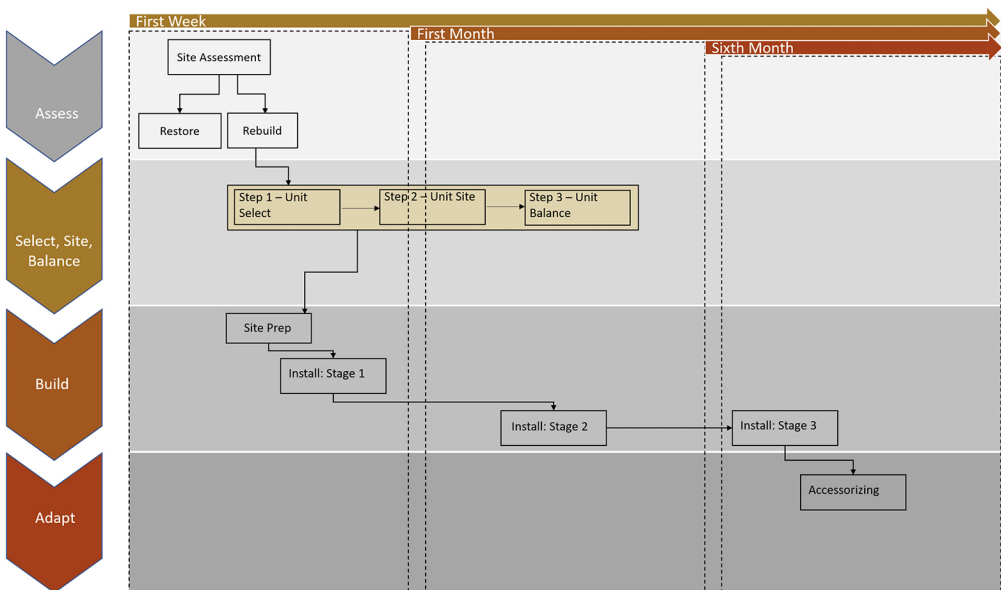

Source: University of Florida project team

Stage 1. Site Assessment

Following a disaster, the Federal Emergency Management Agency (FEMA), local emergency management, and insurance firms evaluate the site to ascertain the degree of damage, the amount of compensation insurance will provide, and the authorization to rebuild and to what extent. As disaster-prone locations become more fragile, several governments are putting into place predisaster strategies to remove them from circulation. FEMA may also identify a location as a property that often sustains losses and advise a buyout rather than reconstruction. Although this procedure is not directly covered by the CORE+, this overview lays the crucial legal and financial foundation for the next stages.

Stage 2. Rebuild Choice and Finance Options: Select, Site, Balance

Stage 2 of the AMH design process is the main emphasis. The team increased the number of steps in this stage to three—selection, site, and balance. Each stage acts as a conduit between a prospective homeowner and the building process. Users may choose the CORE+ assembly that best

suits the unique needs of their site, family, and financing with the support of upfront, monthly, and life-cycle cost alternatives, for which users provided input at each step.

Step 1. Unit Selection

In this step, the customer may choose the number of units (CORE, CORE+SPACE, or CORE+SPACE+DWELL) and the delivery window. This phase determines the unit's overall size and eventual expense (exhibit 5).

Exhibit 5

Select, Site, Balance

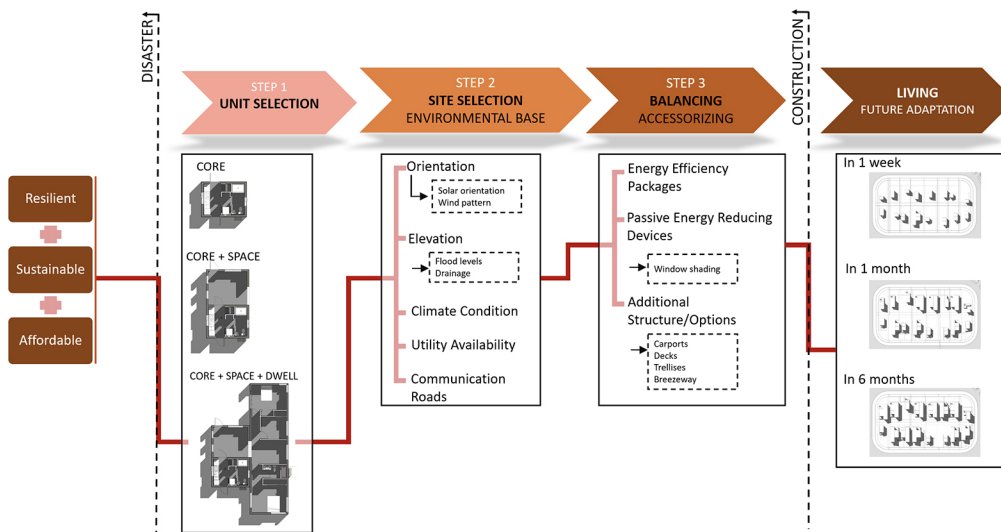

Source: University of Florida project team

Step 2. Site Selection

Given that CORE+ is built for disaster recovery, the precise locations for which the home is intended are exposed to a wide range of dangers. The Southeast of the United States is particularly susceptible to storms, notably those with storm surges and hurricane-force winds. Extreme heat and inland floods are additional dangers. The structure's orientation in respect to the cardinal directions, necessary height above the ground, local solar exposure, and other factors that affect the structure's orientation are all included in its siting. Step 2 would sharpen the unit's cost estimate by adding an anticipated monthly utility bill.

Step 3. Balancing

By giving customers the option to choose between three energy efficiency packages, CORE+ enables owners to further customize the design of the appliance. Window coverings and extra buildings like carports, decks, and trellises are examples of passive energy-saving technologies. The chosen package will further modify CORE+'s base price and anticipated monthly costs and enable

the model to operate under various financial frameworks. The Affordability section provides further financial details.

Stage 3. Build

The CORE+ project includes several different construction phases designed to help people return to their homes after a storm as quickly and efficiently as possible. It begins with the post-disaster deployment of a CORE unit, which may be set up only weeks after a disaster on a site that has been initially cleared. After this preparatory stage, the site preparation phase, which involves installing utilities and laying concrete or block foundations, may start. The modular units may be provided over time, which speeds up installation, although thought is given to simple mechanisms for unit mating.

Stage 4. Adaptation over Time

The design has placed a strong focus on resilience so that homeowners may modify their homes as necessary to meet changing needs. The building's mass-produced shell may be modified to include elements that the community, environment, or building owners like, such as decks, carports, window treatments, and trellises. Adaptations can include decisions made during the balance phase. The structure may be changed to accommodate different locations and needs thanks to the assembly's adjustability. The study estimates the ways communities responded to prior disasters to foresee how a community's strengths and weaknesses would evolve to respond to future dangers. In this sense, CORE+ has taken time into account and permits buyer participation depending on potential future needs.

Building Systems, Life-Cycle Costs, Affordability

In support of the overall design of CORE+ the project included substantial research and development around building systems, life-cycle costs, and affordability. These topics were iteratively incorporated in the design process.

Energy Modeling

In the context of buildings, sustainability is the capacity to reduce the environmental impact via material selection and energy efficiency, while enhancing occupant comfort using ideal daylight, ambient temperature, and enhanced ventilation. Many factors contribute to the decline of total delivered residential energy intensity based on the Annual Energy Outlook reference case, including gains in appliance efficiency, onsite electricity generation (for example, solar photovoltaic), utility energy efficiency rebates, rising residential natural gas prices, lower space heating demand, and a continued population shift to warmer regions (EIA, 2020). As the first measure to reduce the amount of energy a building consumes, proper building design can improve thermal insulation and reduce air leakage by incorporating advanced envelope components (IEA, 2020). Systems have to be selected appropriately for reduced energy use of the whole building, including among others, energy use owing to building envelope, such as walls, roofs, windows, and so on are therefore significant.

The CORE+ project developed a series of whole-building energy models for estimating energy use. Developing energy models of buildings involves extraction, organization, and use of existing building geometry and thermos-physical data as model inputs (Eicker, 2019). Three models were developed for this study—a model that used the National Renewable Energy Laboratory’s report (2016; also referred to as the reference model), a model that used International Energy Conservation Code, and finally, a model that used renewable energy and storage systems to achieve Net Zero Energy—also referred to as the Net Zero Energy Capable building (Cole et al., 2016; ICC, 2018). The Energy Use Intensity (EUI), calculated by dividing the total energy consumed by the building in 1 year (measured in kilo-British thermal units, or kBtu) by the total gross floor area of the building, is used as the basis of comparison between the models (exhibit 6).

Exhibit 6

Total Energy Saving

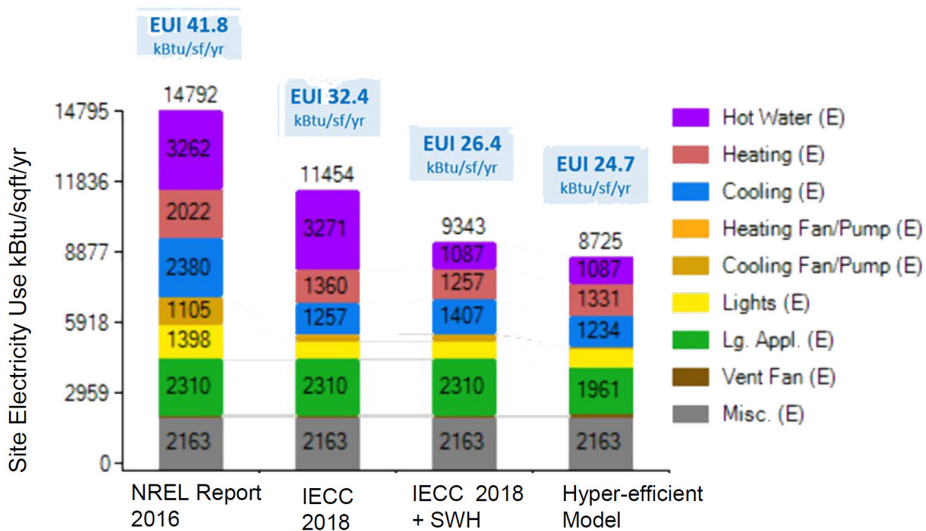

EUI = Energy Use Intensity. IECC = International Energy Conservation Code. kBtu = kilo-British thermal unit. NREL = National Renewable Energy Laboratory. sqft = square foot. SWH = solar water heater. yr = year.
 Source: University of Florida project team

Life-Cycle Economics

A thorough understanding of the life-cycle costs of the CORE+ design and its various energy efficiency options (and related cost savings) will provide homeowners with better knowledge of the actual costs over time. The project team’s design intent is to develop these options such that the final CORE+ module remains affordable.

Under the cost analysis, this study evaluated the initial construction costs, the simple payback period, and the life-cycle costs during a 60-year period. The initial construction cost refers to the costs associated with the building materials, building equipment, and labor in the model. The simple payback period refers to the time required to recover the project investment without considering the time value of money. It is often defined as the break-even point, that is, the year at

which initial investment is offset by the benefits accumulated, which in this case was the energy-associated costs. The project's financial viability was assessed by comparing the payback period of different measures. The life-cycle costs were calculated by summing the net present value of life-cycle expenses associated with the loan, home maintenance, replacement cost, and utility bills.

Affordability

Disasters exacerbate the existing affordable housing problem through a combination of dislocation, physical loss of inventory, and local housing market short- and long-term impacts. The CORE+ module can help to enhance the resilience and sustainability of traditional manufactured and modular housing designs. This project suggests manufactured housing provides an affordable homeownership alternative compared with increasingly expensive single-family homes (Shimberg, 2020). In the first half of 2021, the median sale price for a single-family home was nearly three times as much as the price of a manufactured housing parcel (\$324,900 versus \$112,500).

Manufactured housing also provides a form of naturally occurring affordable housing for renters. Although small in number, the manufactured housing rental supply provides units that are far more affordable than other market-rate alternatives. The median gross rent for a manufactured housing unit in Florida is \$800 per month compared with \$1,400 for a single-family home and \$1,070–\$1,380 for multifamily units (Census Bureau, 2019). In fact, the \$800 median manufactured housing rent is lower than the \$971 median gross rent in Florida Housing Finance Corporation's multifamily portfolio, the largest source of subsidized rental housing in the state.

Exhibit 7

Section Drawing Through Core Module



Source: University of Florida project team

The development of CORE+ modules will directly address a key problem for Florida's lower-income homeowners—the high cost of energy consumption and its contribution to the housing cost burden. Housing is usually considered affordable if no more than 30 percent of household income is devoted to housing costs, including utility consumption. In Florida, 767,000 homeowners with annual incomes less than \$35,000 pay more than this percentage for their housing, including 432,000 owners with incomes less than \$20,000 (Census Bureau, 2021). For low-income families, the cost of utilities may amount to as much as one-third of their monthly rent or mortgage payment. Although low-income homeowners typically pay slightly less for utilities than other homeowners, they still pay more than they can afford on average. Florida homes, on average, spend \$200 a month on utilities. Owners whose annual income is less than \$20,000 pay \$150 (Census Bureau, 2019). About one-quarter of the median cost of housing goes toward utilities, which is higher than other essential costs like property taxes and insurance. The CORE+ project and the resulting CORE+ model were developed to provide post-disaster housing to those least able to afford it. Further, the CORE+ module is designed to mitigate future risks from energy costs, as well as from storms. Further development of the CORE+ module to the prototype level will further investigate these issues.

Design Workshop and Refining the CORE+: North Port St. Joe

Hurricane Michael, which made landfall in 2019 in the Florida panhandle as an unprecedented category 5 hurricane, caused catastrophic wind and storm surge damage to the coastal city of Port St. Joe. Some of the effects in Port St. Joe include infrastructure loss, road and building destruction, erosion along the St. Joseph's peninsula, and power outages. The neighborhood of North Port St. Joe was spared substantial flooding from the storm, but wind damage and the legacy of poor construction and poverty meant that damage was significant, and recovery has been very slow.

In 2021, the North Port St. Joe Project Area Coalition presented a community workshop in North Port St. Joe that featured the CORE+ module to address pervasive substandard housing. Led by the University of Florida's Florida Resilient Cities program partnering with the Florida A&M University Architecture program and faculty from across the University of Florida's College of Design, Construction and Planning, the workshop leveraged ongoing university research and outreach efforts. The Jessie Ball Dupont Fund, the U.S. Economic Development Administration, and HUD sponsored the workshop, which partnered with additional expert and community stakeholders to provide innovative housing, landscape, and public policy solutions to residents of North Port St. Joe.

The workshop engaged community stakeholders, elected officials, policymakers, and funders through a series of interactive events and covered all described components of the problems in Port St. Joe and featured four themes, including:

- Housing policy and land tenure.
- Stormwater and landscape.
- Mixed-use development on Martin Luther King Boulevard.
- Modular housing (CORE+).

The modular housing team had the main goal to identify the modular housing design options that can meet select community members' needs for housing that is rapidly constructed, affordable, and energy efficient. The team's objective was to work with community volunteers on specific sites for housing and assessment concerns and opportunities for the deployment of new single-family modular homes. The team worked with the CORE+ model to design, specify, and price the home in six sites that community residents offered (exhibit 8). The team worked with clients to fit homes to space needs, site conditions, and budgets. The design was coordinated with the city of Port St. Joe to ensure that homes meet all local zoning and building codes.

Exhibit 8

Six Site Locations Proposed by Community Members in North Port St. Joe, Where the Team Tested the CORE+ Model

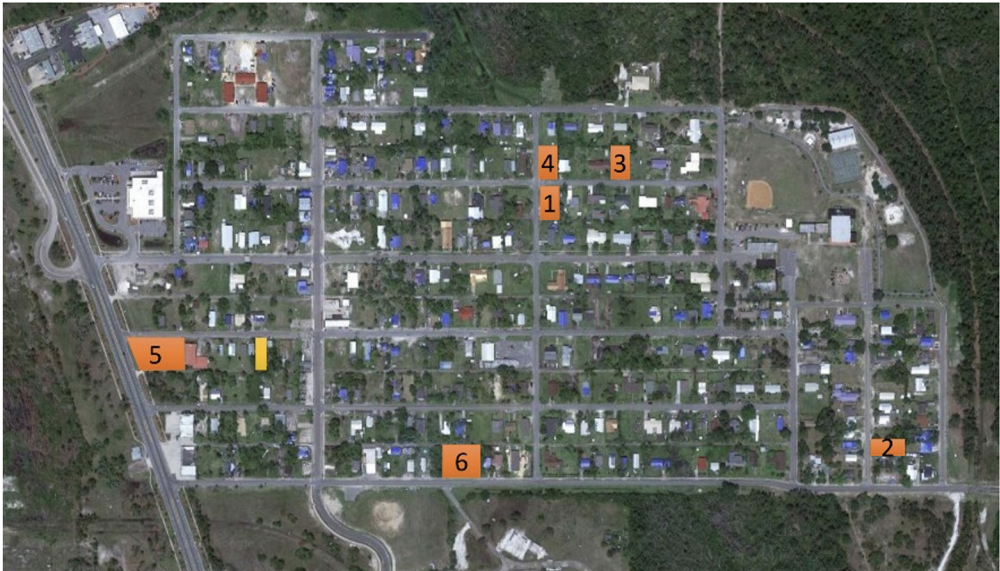

Source: University of Florida project team

The design development started with conversations with community members as potential clients to understand the needs of the community. Community members suggested six potential sites, and the design team evaluated the flood zone and other site conditions. Then, the design team developed the specific plans shaped by the CORE+ project for each of the six sites, and the team discussed various building options with community members. The design team created a profile that included clients' and existing site requirements, a comparison of the suggested modular home's energy use to that of a typical single-family home, a quantity takeoff for the suggested modular home, and a three-dimensional model of the specific design for each of the six sites (exhibit 8). The team received valuable feedback from active community members. Some of the design recommendations that the team offered to help with the design to best fit a user includes adding a front porch, deck, carport, addition of another SPACE unit, and breezeways between the units that can also be used as extra space and that can be covered. Each

site with a different orientation and specification and owner requirement was modeled, and the cost and energy consumption were estimated.

Exhibit 9

Site Number 1 Design Profile that the Team Created

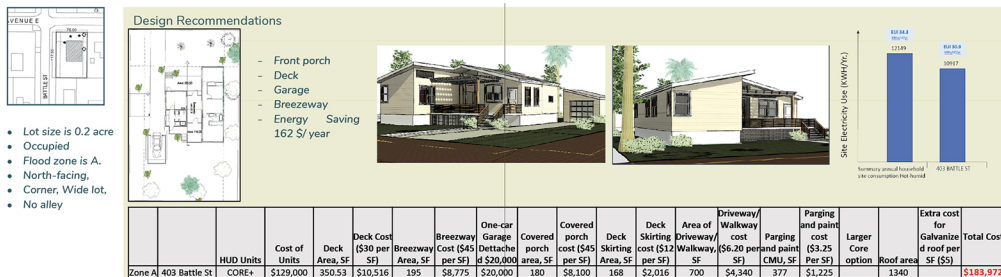

CMU = concrete masonry unit. SF = square feet.

Source: University of Florida project team

The modular housing design team met with the community members and shared their ideas on the development of the CORE+ design in North Port St. Joe. In conclusion, the major outcome of the workshop is about actively collaborating with the community and listening to and receiving feedback regarding the design process. The design team made its contribution to the workshop by presenting the existing options for modular housing and listening to and applying community suggestions and specific needs based on the community preferences and the site requirement. The modular housing team considered the long-term view of the design as a characteristic of a resilient community (exhibit 10).

Exhibit 10

CORE+ Unit with Added Breezeways Between Units and Other Design Modifications After Years of Unit Installation and Adaption of CORE+ Design Capacity, Resulting from Community Workshop

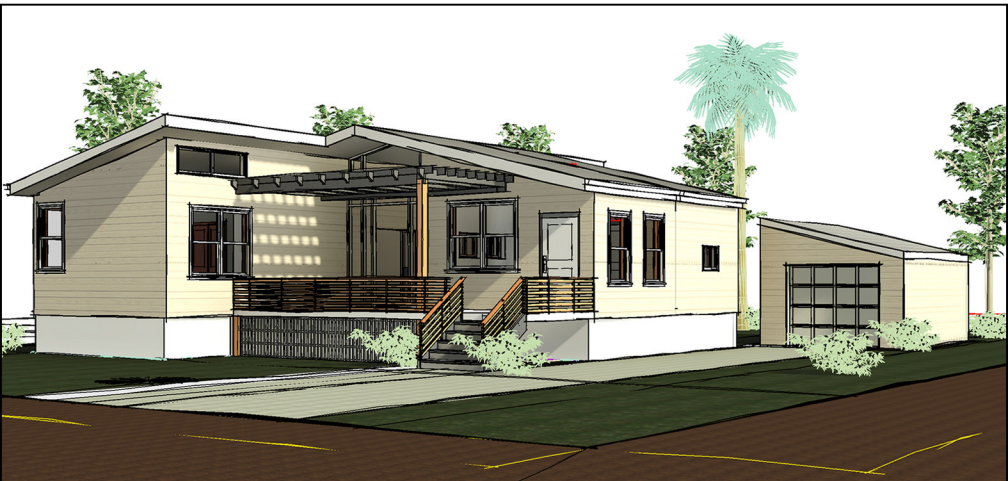
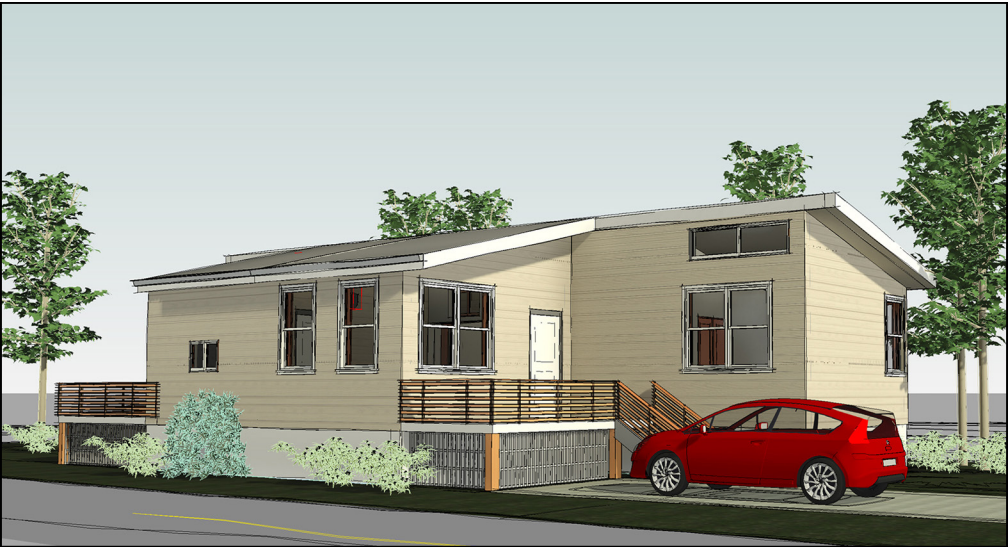

Source: University of Florida project team

Conclusion

The University of Florida's CORE+ project started with partnerships, including the modular home manufacturing industry and other industry and community stakeholders. From the diversity of external expertise and interest, the team developed a project that is innovative, affordable, and buildable. The project tackles the three key challenges facing the U.S. housing industry—rapid deployment following a disaster, energy efficiency and performance, and affordability. The design

used industry standard construction where effective, but also brings substantial efficiency to the construction process through mass customization techniques.

The challenge that this project takes on—the rapid delivery of efficient, resilient, and affordable housing in vulnerable locations—is a problem facing many regions of the United States. Following countless hurricanes, including the unfolding humanitarian disaster caused by Hurricane Ian, housing is of utmost importance to communities seeking to stabilize and rebuild. The CORE+ module is a climate-responsive design that makes use of passive energy design principles to create a hyper-energy-efficient building that can be outfitted with cutting-edge heating, ventilation, air-conditioning, and electrical infrastructure, as well as renewable energy sources, like solar power. The CORE+ project prioritized resiliency in two ways. First, the CORE+ unit is structurally the most durable of the three. When it comes to wind loading, passive heating and cooling strategies, and systems to mitigate extended power failures, the CORE+ unit design not only meets but exceeds all Florida building code requirements. The module also includes a cost-effective piling system that makes elevating homes to varying levels simple. Second, the AMH is designed with adaptability and resilience in mind from the start. It provides flexibility for the consumer to adapt the housing units based on their dwelling and lifestyle during a preferred period. Third, the AMH design overcame the cost barrier by factoring in energy usage information to the life-cycle cost. The results of this study show that this method may be used to enhance the sustainability and resilience of conventional and modular house design.

Acknowledgments

The content contained in this article reflects the views of the authors and does not necessarily reflect the views of HUD. This project is funded by the HUD Project Award Number H-21683 CA, and the authors are gratefully thankful for the funding. Further, the authors thank Jagruti Rekhi for managing and coordinating this work on HUD's behalf. Finally, the authors thank the editors and two referees for their helpful comments.

Authors

Jeff Carney is an associate professor at the School of Architecture and director of the Florida Institute for Built Environment Resilience (FIBER) at the University of Florida. Ravi Srinivasan is an associate professor at the Rinker School of Construction Management and director of graduate programs and research at the University of Florida. Stephen Bender is a professor and director of CityLab-Orlando at the University of Florida. Bill O'Dell is an associate professor in the School of Construction Management and director of the Shimberg Center for Housing Studies at the University of Florida. Ryan Sharston is an assistant professor at the University of Florida. Abdol Chini is a professor in the School of Construction Management at the University of Florida. Forough Foroutan is a Research Assistant in FIBER and a PhD student at the University of Florida.

References

- Brown, Becky J., Mark E. Hanson, Diana M. Liverman, and Robert W. Merideth. 1987. "Global Sustainability: Toward Definition," *Environmental Management* 11 (6): 713–719. <https://doi.org/10.1007/BF01867238>.
- Cole, Wesley, Parthiv Kurup, Maureen Hand, David Feldman, Benjamin Sigrin, Eric Lantz, Tyler Stehly, Chad Augustine, Patrick O'Conner, and Connor Waldoch. 2016. *2016 Annual Technology Baseline (ATB)*. Golden, CO: National Renewable Energy Laboratory (NREL). <https://www.nrel.gov/docs/fy16osti/66944.pdf>.
- Eicker, Ursula, ed. 2019. "Building Energy Demand Modeling: From Individual Buildings to Urban Scale." In *Urban Energy Systems for Low-Carbon Cities*. Cambridge: Academic Press: 79–136. <https://doi.org/10.1016/B978-0-12-811553-4.00003-2>.
- Gunawardena, Tharaka, Tuan Ngo, Priyan Mendis, Lu Aye, and Robert Crawford. 2014. "Time-Efficient Post-Disaster Housing Reconstruction with Prefabricated Modular Structures," *Open House International* 39 (3): 59–69.
- Hancock, Karen E. 1993. "Can Pay? Won't Pay?" or Economic Principles of 'Affordability,'" *Urban Studies* 30 (1): 127–145.
- Holling, C. S. 1973. "Resilience and Stability of Ecological Systems," *Annual Review of Ecology and Systematics* 4 (1): 1–23. <https://doi.org/10.1146/annureves.04.110173.000245>.
- International Energy Agency (IEA). 2020. "Space Cooling – Analysis." <https://www.iea.org/reports/space-cooling>.
- International Code Council (ICC). 2018. 2018 International Energy Conservation Code (IECC). <https://codes.iccsafe.org/content/iecc2018>.
- NOAA. 2022. "Detailed List of Continental United States Hurricane Impacts/Landfalls 1851–1970, 1983–2021." National Oceanic and Atmospheric Administration. https://www.aoml.noaa.gov/hrd/hurdat/UShurrs_detailed.html.
- Larsen, Maria S. S., Soren M. Lindhard, Thomas D. Brunoe, Kjeld Nielsen, and Jesper K. Larsen. 2019. "Mass Customization in the House Building Industry: Literature Review and Research Directions," *Frontiers in Built Environment* 5: 1–12. <https://doi.org/10.3389/fbuil.2019.00115>.
- Mamouni Linnios, Elena A., Tim Mazzarol, Anas Ghadouani, and Steven G. M. Schilizzi. 2014. "The Resilience Architecture Framework: Four Organizational Archetypes," *European Management Journal* 32 (1): 104–116.
- McAllister, Therese. 2016. "Research Needs for Developing a Risk-Informed Methodology for Community Resilience," *Journal of Structural Engineering* 142 (8): C4015008. [https://doi.org/10.1061/\(ASCE\)ST.1943-541X.0001379](https://doi.org/10.1061/(ASCE)ST.1943-541X.0001379).

National Renewable Energy Laboratory. 2016. "2016 Renewable Energy Data Book." <https://www.nrel.gov/docs/fy18osti/70231.pdf>.

Phillips, R., Luke Troup, David Fannon, and Matthew J. Eckelman. 2017. "Do Resilient and Sustainable Design Strategies Conflict in Commercial Buildings? A Critical Analysis of Existing Resilient Building Frameworks and Their Sustainability Implications," *Energy and Buildings* 146: 295–311. <https://doi.org/10.1016/j.enbuild.2017.04.009>.

Santillo, David. 2007. "Reclaiming the Definition of Sustainability," *Environmental Science and Pollution Research International* 14 (1): 60–66. <https://doi.org/10.1065/espr2007.01.375>.

Shimberg Center for Housing Studies (Shimberg). 2020. "Florida Housing Data Clearinghouse." <http://flhousingdata.shimberg.ufl.edu/>.

U.S. Census Bureau (Census Bureau). 2019. "U.S. Census Bureau, 2019 American Community Survey Public Use Microdata Sample (PUMS)." <https://www.census.gov/programs-surveys/acs/microdata.html>.

———. 2021. "American Community Survey Data." <https://www.census.gov/programs-surveys/acs/data.html>.

U.S. Department of Energy (DOE). 2015. "Guide to Determining Climate Regions by County." In *Building America Best Practices Series*. <https://www.energy.gov/eere/buildings/downloads/building-america-best-practices-series-volume-73-guide-determining-climate>.

U.S. Department of Housing and Urban Development (HUD). n.d. "Rental Burdens: Rethinking Affordability Measures." https://www.huduser.gov/portal/pdredge/pdr_edge_featd_article_092214.html.

U.S. Energy Information Administration (EIA). 2020. "Annual Energy Outlook 2020 with Projections to 2050." <https://www.eia.gov/outlooks/aeo/pdf/AEO2020%20Full%20Report.pdf>

Walker, Brian, C. S. Holling, Stephen R. Carpenter, and Ann Kinzig. 2004. "Resilience, Adaptability and Transformability in Social-Ecological Systems," *Ecology and Society* 9 (2): 1–10. <https://doi.org/10.5751/ES-00650-090205>.

Wamsler, Christine. 2010. "Reducing Risk in a Changing Climate: Changing Paradigms Toward Urban Pro-Poor Adaptation," *Open House International* 35 (1): 6–25.

Getting Cross-Laminated Timber into U.S. Design Codes: A Must for Affordable and Sustainable Multifamily Housing

John W. van de Lindt
Colorado State University

Maria Koliou
Texas A&M University

Pouria Bahmani
Washington State University

Abstract

Cross-laminated timber (CLT) is revolutionizing the building industry around the world by providing a sustainable, eco-friendly alternative to traditional steel and concrete in multifamily and other buildings. As a new technology, CLT must be fully studied to ensure the safety of occupants before incorporating it in U.S. building codes for routine use. U.S. design codes allow for special alternative procedures to be used for a new system, but alternative methods can be expensive and time consuming. Although CLT construction projects are underway, each is unique and somewhat expensive; therefore, to make CLT multifamily housing more affordable, seismic performance factors have to be developed for earthquake-prone regions of the United States. This article provides a brief overview of how HUD-funded researchers are working toward having the most important seismic performance factor (R-factor) adopted for use in U.S. building codes, thereby making CLT an affordable option for multifamily housing construction.

Introduction

Cross-laminated timber (CLT) is an innovative construction product that originated in Europe approximately 20 years ago and has gained considerable momentum in North America, starting with buildings in Canada and now, the United States. A team of engineers recently completed a comprehensive process to enable platform-style CLT to be proposed for inclusion in U.S. design

codes (van de Lindt et al., 2020). Platform-style construction is standard when one story of walls is constructed, a floor system built on top, the next story of walls added, and so on. This is the predominant style of wood-frame building construction in the United States, particularly for single-family homes and many multifamily buildings. However, a less expensive and faster construction approach using CLT is balloon-style construction, in which three- or four-story CLT walls are tilted up and floor systems hung from them, serving as horizontal diaphragms and providing lateral stability. However, balloon-style CLT systems have not been explored enough to be able to be used effectively in multifamily housing units in the United States. The overall goal of this project is to enable construction of balloon-style CLT buildings, such as low-rise single- and multistory residential buildings, including apartment complexes. This project will remove a building code barrier to balloon CLT construction through a systematic research program, thereby enabling this new technology to be used economically and efficiently in multifamily housing projects.

Two major barriers exist to using CLT in the United States: (1) CLT is not approved for use in seismic regions of the United States except through a direct (and time-consuming, expensive) approval by local building officials, necessitating individual building approval and, at times, certified laboratory testing of connections, which renders CLT technology less competitive; therefore, it is not used. (2) Platform-style CLT can be used for up to six stories—because such a project was completed, and the process is now in U.S. design codes (van de Lindt et al. 2020)—and uses narrow shear walls, which are not conducive to cost-effective construction in seismic regions—particularly for residential structures.

CLT has now been commonly accepted as a next-generation engineered wood product that has the potential to expand the wood building market (UNECE/FAO, 2017). Although CLT was introduced more than two decades ago, only in the past decade or so have researchers started focusing on using CLT as a lateral force resisting system in buildings. The number of studies investigating CLT system behavior and performance under cyclic and dynamic loading subsequently increased. Most of those studies originated in Europe (e.g., Ceccotti, 2008; Dujic, Aicher, and Zarni, 2006; Hristovski et al., 2012) and, more recently, in North America (e.g., Pei et al., 2016; Popovski, Schneider, and Schweinsteiger, 2010; Popovski and Gavric, 2015) and Japan (e.g., Okabe et al., 2012; Tsuchimoto et al., 2014). The studies demonstrated that CLT systems can be effectively used as a lateral force resisting system, in which the structural system has shear walls that resist impacts from earthquakes; a review of some of those studies is provided in Pei et al. (2016). With the introduction of CLT to the U.S. construction market and the current modern urbanization trend (Alig, Kline, and Lichtenstein, 2004), many believe that CLT can fill a gap for certain regions of the United States, providing a mechanism for sustainable and resilient residential construction.

The process to incorporate a new seismic force resisting system (SFRS) into U.S. design codes will take years, and it requires a robust combination of experimental data and numerical analysis, both of which are explained below. Federal Emergency Management Agency (FEMA) Report P695 (2009) provides a rational procedure to calculate the margin against collapse for a portfolio of representative archetypes from the proposed lateral force resisting system. This methodology is also explained below, and exhibit 1 shows the basic components of a FEMA P695 analysis. The system concept for balloon framing of CLT wall systems is developed first, and then information is obtained on all relevant components. The behavior is then characterized, typically using an

experimental program, as was done in this project. Models are developed for computer simulation (which was done in OpenSees software in this project) and then a robust analysis is conducted, with approximately 500,000 to 1,000,000 analyses to fully understand the system and evaluate its performance. The performance evaluation requires using specified methods in FEMA P695 to assess the margin against collapse to ensure that the new system is at least as safe as existing systems in the United States. The process can be iterative and require full redesign and remodeling of the archetypes, so it is time consuming. At the time of this report, the process is in redesign based on negotiations with the expert panel and code committees.

Exhibit 1

Overview of FEMA P695 Methodology

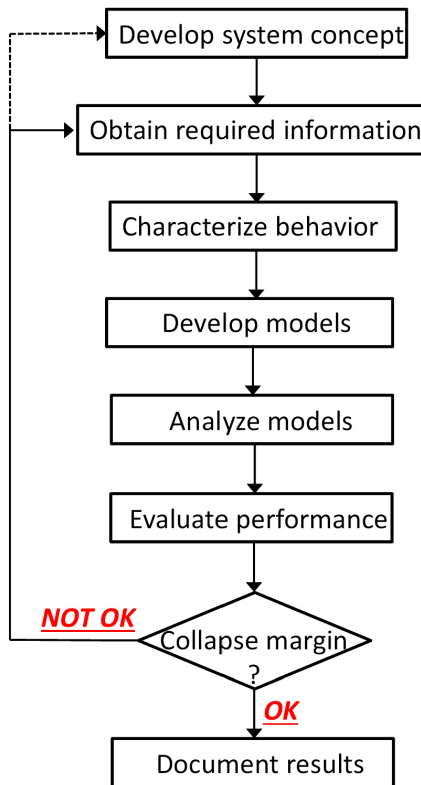

Source: Based on concepts from Federal Emergency Management Agency (FEMA)

Experiments on Cross-Laminated Timber

A significant portion of the existing literature has focused on evaluating the performance of connections in CLT structures. Connections are the components that sustain damage in wood construction, and testing them is critical to evaluating their performance. Testing is needed to establish model parameters at the connection level to aid in accurately developing full-scale representations of building behavior.

This approach is also a systematic way of minimizing uncertainties in computational modeling, given that the feasibility (in terms of availability of resources and number of tests performed) of performing many full-scale shake table tests is low compared to the cost associated with full-scale testing. In this study, detailed uniaxial¹ and biaxial² testing on CLT connections in two levels (connection tests and biaxial wall tests with focus on the connection response) were performed. All connection tests focused on evaluating the response of the panel-to-panel and wall-to-floor connections. Exhibits 2a and 2b show a rendering of the testing setup on a uniaxial testing machine for panel-to-panel connections and the biaxial wall test configuration with floor diaphragm, respectively. In addition, exhibits 3 and 4 show photos of the panel-to-panel test specimens and wall-to-floor specimen connections, respectively, and exhibit 5 displays photos from the full-scale wall tests.

Exhibit 2

Rendering of (a) Panel-to-Panel Connection Setup and (b) Biaxial Wall Test with Floor Diaphragm

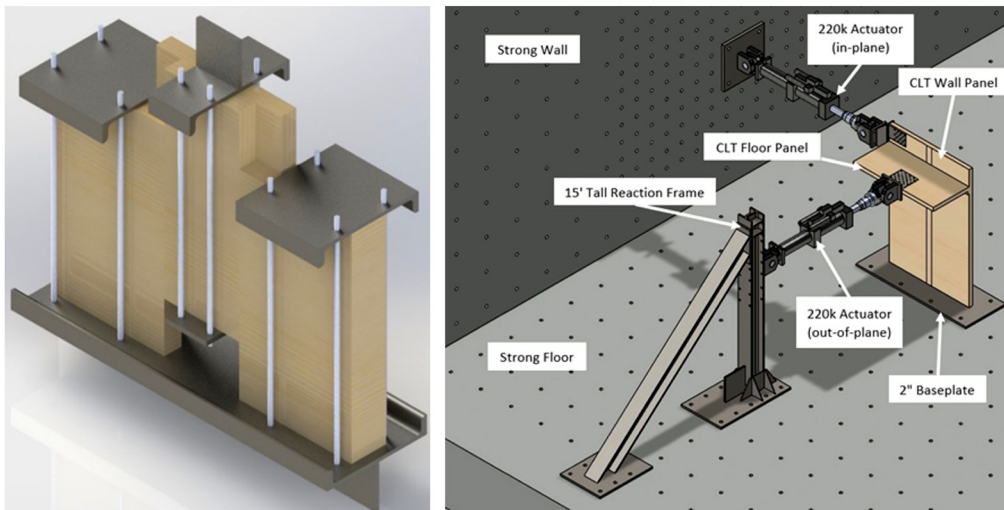

(a)

Source: Hayes (2021)

(b)

¹ In uniaxial testing, a sample is subjected to a uniaxial force until failure. The uniaxial force can be applied as either a tension or a compression.

² In biaxial testing, a sample is subjected to forces in both the x and y directions.

Exhibit 3

Photos of the Panel-to-Panel Test Specimens and Setup (Specimen Setups Represent Typical Panel-to-Panel Connections That Can Be Seen in CLT Buildings)

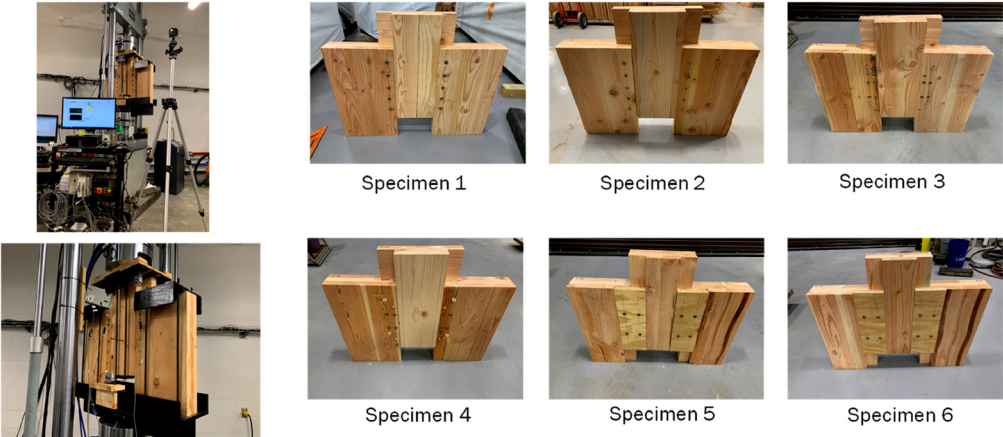

Source: Hayes (2021)

Exhibit 4

Photos of the Wall-to-Floor Test Specimens and Setup (Specimen Setups Represent Typical Panel-to-Panel Connections That Can Be Seen in CLT Buildings)

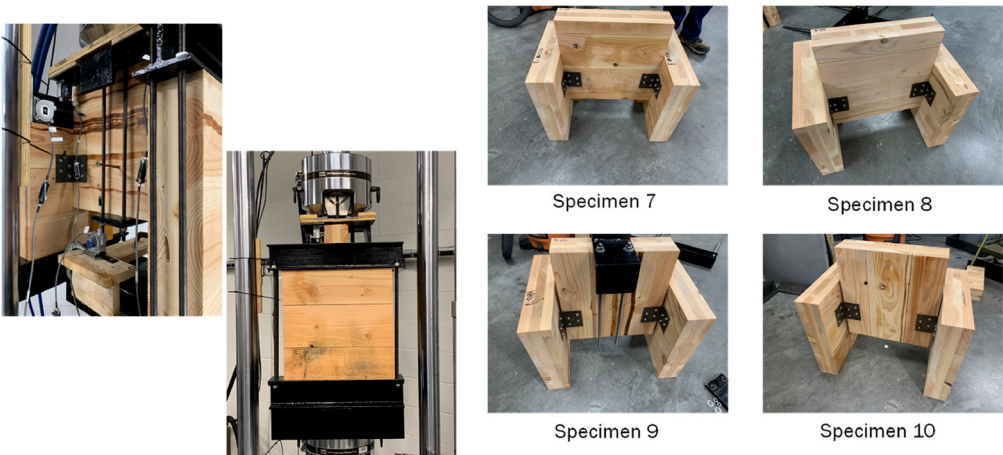

Source: Hayes (2021)

Exhibit 5

Photos of Full-Scale Specimens and Setup: (a) Tests With Floor Diaphragm, (b) Tests Without Floor Diaphragm

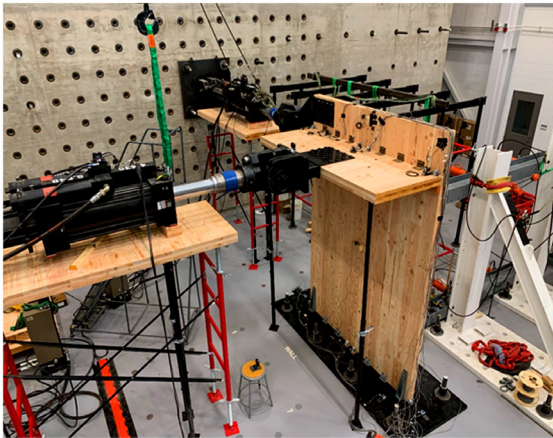

(a)



(b)

Source: Hayes (2021)

The connection-level and full-scale wall tests conducted as part of this study revealed that all connection configurations (including half-lap and surface spine) tested are viable methods of construction for use in balloon-style CLT construction. All configurations outperformed their design code predictions. The design code provides a significant factor of safety for designers, and nearly all test configurations had a safety factor of greater than 2, with some test configurations exhibiting a safety factor of nearly 6.

The results of this experimental program were then used to provide modeling parameters for the typical CLT balloon frame connection at the building-level modeling efforts.

Archetype Buildings and Seismic Response Modification Factors

Structures can behave in two ways when subjected to lateral loads. Some structures deflect and deform under the load, but they do not experience any damage during the application of load or have any residual deformation after the load is removed. This behavior is called *linear-elastic response*. In linear-elastic structures, all the work done to deform the structure is recoverable, and no energy dissipates in the loading and unloading process. On the other hand, some structures can experience various levels of damage when subjected to load and will have residual deformation after they have been fully unloaded. In those structures, the work done to deform the structure is not fully recoverable; some part of the work permanently deforms the structure (i.e., residual deformation). Those structures are called *nonlinear-inelastic structures*. During an earthquake, many buildings behave inelastically and experience some level of damage. At first, that behavior may be seen as a disadvantage for structures to experience damage during a high-intensity earthquake, but that phenomenon can help the structure resist the seismic load better and prevent catastrophic collapse. Small and localized damage throughout can dissipate a lot of seismic energy imposed on the structure; hence, it reduces the overall

deformation of the structure to a safe range. The job of structural engineers and researchers is to find a way to design connections and members to dissipate and damp the seismic energy throughout the building without compromising the safety of the structure.

Designing a linear-elastic structure that does not undergo any damage is not economical and cannot be justified (except for some facilities in which avoidance of damage is essential, such as nuclear power plants). The return period for a high-intensity earthquake is 500 to 2,500 years (i.e., one such earthquake is not likely to occur for at least 500 years), depending on the seismic region where the building is being built. So, the probability of having such an earthquake during the lifetime of the structure would be very low; therefore, designing a building that can tolerate some level of damage during a high-intensity seismic event without comprising the safety of its residents is justifiable.

As mentioned previously, a *linear-elastic* structure does not dissipate energy and does not have the capability to reduce the seismic forces due to lack of damping the seismic energy, leading to uneconomical design. On the other hand, if a building can undergo some level of inelasticity (e.g., small cracks in concrete buildings or small deformations in timber buildings), the seismic energy imposed on the building will be reduced significantly and will result in far lower forces than if the building were designed to remain undamaged. Exhibit 6 presents the reduction of forces induced due to a seismic event in a structure from a linear-elastic response to a nonlinear-elastic response. The exhibit shows that if structures are designed to undergo some level of inelasticity, the forces can be reduced by at least a factor of R (in some structures, that reduction is on the order of 2 to 8).

Exhibit 6

The True Inelastic (Solid Line) Versus Elastic (Dashed Line) Response of a Structure Subjected to Seismic Loading

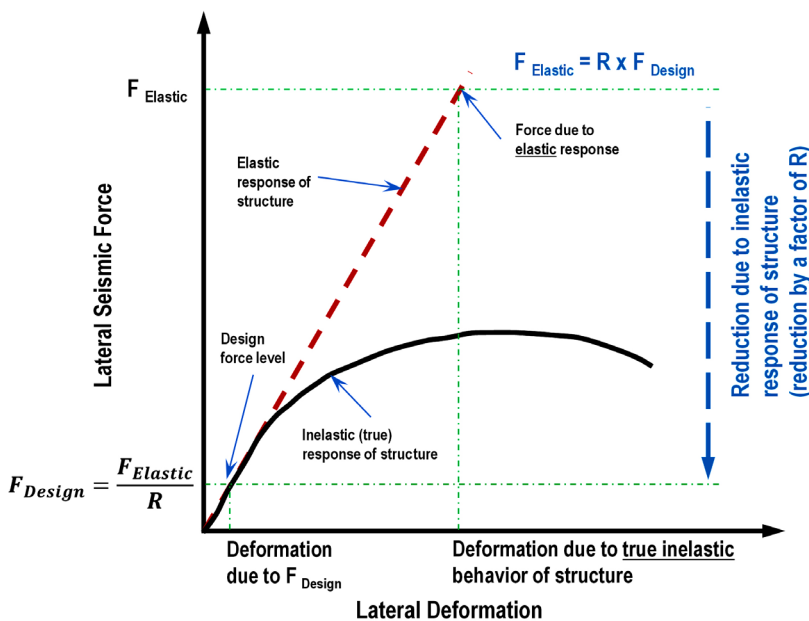

Source: Drawing by contributing author, Pouria Bahmani

The inelastic response of members and connections is mostly due to the material properties and the nature and behavior of members and connections of the structure. To take advantage of inelasticity in material, which leads to lower internal forces in a structure and more affordable houses, the inelasticity in material must be modeled correctly using programming software. Such modeling will allow engineers to understand the “true” behavior of structures under seismic loading. The process of modeling each member and connection in a software program to represent its true inelastic behavior is very cumbersome and time-intensive and requires several days—even months—of analysis and high computational power. That process increases the design time and leads to a very expensive and time-consuming design procedure that ultimately increases the construction cost of buildings and structures, which defeats the purpose of using inelastic design of structures: more affordable buildings and structures. To address the inelasticity and nonlinear behavior of a structure during a seismic event and, at the same time, simplify the analysis and design procedure, response modification factors (i.e., R-factors) are used in building codes and standards. As shown in exhibit 6, if the R-factor for a specific lateral load resisting system is known, all members can be designed for a reduced load of $F_{\text{Design}} = F_{\text{Elastic}}/R$ by considering the inelastic behavior of the structure and without going through a time-consuming analysis and design process. In summary, the R-factors can be considered shortcuts that allow practitioners and engineers to consider the true behavior of structures and take advantage of reduced forces to establish a safe and economical design. The level of inelasticity and damage in structures that leads to the definition of R-factors must be in an acceptable range and must be investigated very carefully through a research program. In this study, the procedure described in the FEMA P695 guidelines, developed by FEMA in collaboration with Applied Technology Council (ATC) (FEMA, 2009), is used to determine the R-factor and margin against collapse of buildings.

FEMA P695 Procedure

To determine the R-factor and margin against collapse for balloon-type structures, the authors designed several building archetypes using current building code provisions in *Minimum Design Loads and Associated Criteria for Buildings and Other Structures*, ASC/SEI 7-22 (ASCE, 2022). The archetypes were subjected to a suite of ground motions (from the FEMA P695 far-field ensemble) with increasing intensities. To determine the R-factor for balloon-type structures, the authors considered all possible configurations of traditional residential and open-floor office buildings. Doing so allows generalization of the seismic modification and gives practitioners and structural engineers flexibility in using those factors to design more affordable houses. Per FEMA P695, archetype buildings should first be grouped based on building use, aspect ratios (height-to-width ratio) of shear walls, and design parameters. Exhibit 7 presents typical three- and eight-story balloon-type buildings used in this study, and exhibit 8 presents the performance groups considered in applying the FEMA P695 collapse assessment methodology for the proposed R-factor.

Exhibit 7

Building Archetypes: Three- and Eight-Story Buildings



Source: Drawing by contributing author, Pouria Bahmani

Exhibit 8

Building Archetypes and Performance Groups

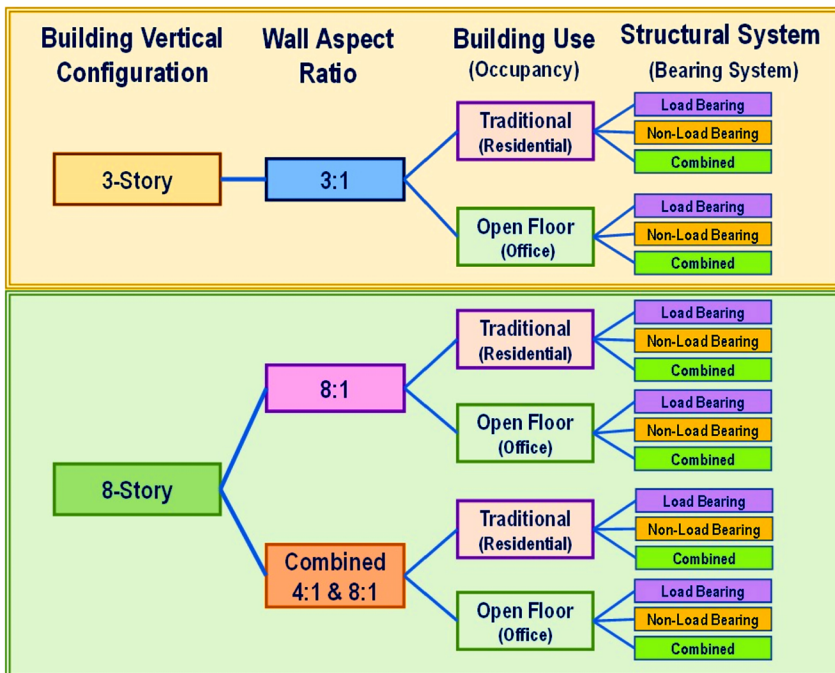

Source: Drawing by contributing author, Pouria Bahmani

In the next step, each archetype was designed in accordance with the Equivalent Lateral Force (ELF) procedure described in ASCE 7-22 for a range of response modification coefficients (i.e., R-factors) and was subjected to a suite of ground motions consisting of 22 earthquake records with increasing intensity. This task, as mentioned previously, requires thousands of nonlinear analyses to monitor the responses of all archetypes and, hence, is computationally intensive. Maximum displacements at each story and, consequently, maximum displacement for the overall structure, can then be monitored for each ground motion. This process allows one to determine the maximum displacement responses of all archetypes, and margin against collapse can be determined using statistical methods per the FEMA P695 guideline. Exhibit 9 depicts the FEMA P695 procedure to determine the R-factors.

Exhibit 9

Schematic of the FEMA P695 Process to Determine R-Factors for Balloon-Type Structures

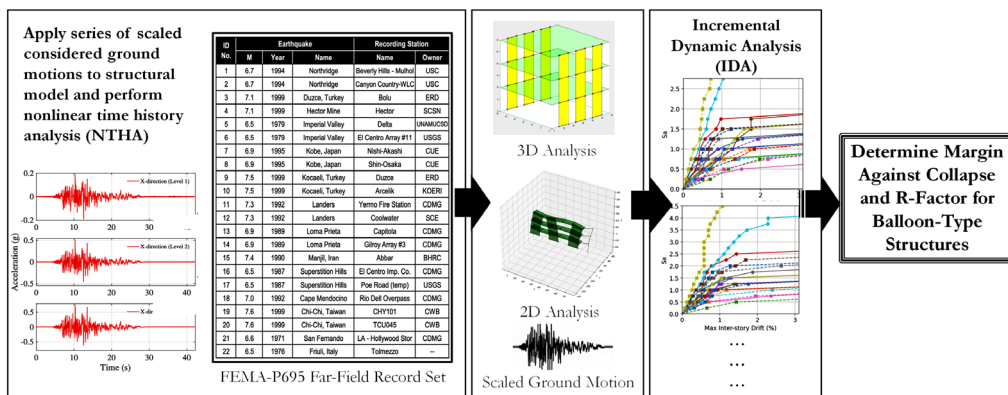

Source: This exhibit developed by the authors

Exhibit 10 shows the number of possible nonlinear analyses that must be completed to determine the R-factor for balloon-type structures. The first column in the exhibit shows a range of R-factors that are considered in this study. Each R-factor can be considered a “trial” R-factor that can be used to design a balloon-type building if the margin against collapse is in an acceptable range based on the FEMA P695 guideline. The second column presents a list of archetype buildings (total of 36) that are used in this study. The third column presents the increase in intensity of ground motions. Ground motion records can be scaled to spectral acceleration to have higher or lower intensities. Therefore, if a wide range of spectral acceleration is used, all possible ground motion intensities can be studied, and the response of the archetype building to each ground motion can be investigated. The last column shows the 22 far-field ground motions from the FEMA P695 guideline. These ground motions were selected such that they include all possible types of ground motions, with different durations and maximum ground acceleration. Therefore, by going through column 1 to column 4 of exhibit 10, all possible balloon-type structures and possible ground motions with different intensities were investigated. An estimated half a million nonlinear analyses must be conducted as part of this study, which require high computational power to complete. Supercomputers are used to reduce the analysis time. The analyses will be conducted in this study to determine the R-factor so that practicing engineers do not need to run nonlinear analysis to design

balloon-type structures, which will save a lot of time and effort during the design of multifamily residential or office buildings. This process ultimately reduces the cost of designing and constructing mass timber balloon-type structures and leads to more affordable housing in the United States.

Exhibit 10

Estimated Number of Nonlinear Analyses Required to Determine R-Factor

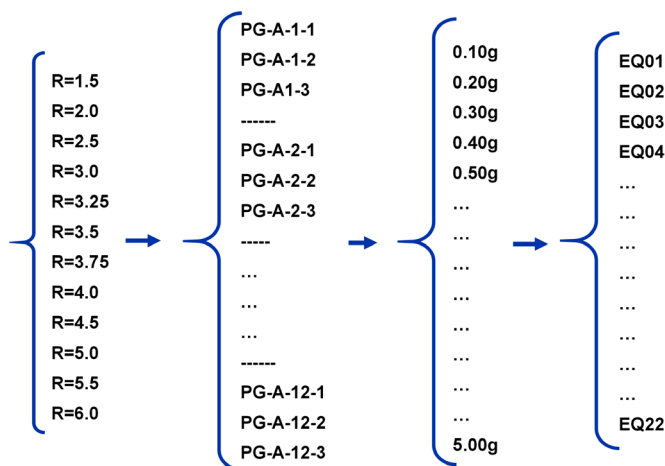

$$\sim 12 \text{ R-Factors} \times 36 \text{ Archetype Buildings} \times \sim 50 \text{ Spectral Accelerations} \times 22 \text{ Ground Motions} = \sim 500,000 \text{ Analyses}$$

Source: This exhibit developed by the authors

U.S. Design Code Adoption Process

Based on the work of the authors, a best practices document for balloon-type CLT construction will be developed and will serve directly as the design code proposal to the Provisions Update Committee (PUC) of the Building Seismic Safety Council (BSSC) and eventually be used to add the design procedure to ASCE 7 in 2028. Before full adoption, the process document will be available to local engineers and architects to adopt, with the approval of their local building officials. The adoption process is time-consuming and relies on a proposal and then a balloting process and finally a public comment period to ensure the safety of all housing and buildings in the United States. However, mass timber—in this case, cross-laminated timber—will ultimately provide a cost-effective, sustainable alternative for multifamily housing far into the future. After all, wood is the most sustainable construction material on Earth.

Conclusions

Cross-laminated timber balloon-style multifamily construction is on the cusp of becoming a mainstream reality, provided it can be made more cost effective. This HUD-supported project is providing the technical support, evidence, and guidance to make that reality possible through a rigorous testing and analysis program, which will work its way through the U.S. design code

process. This process is, at times, cumbersome but nonetheless ensures that U.S. building codes are some of the safest and regulated standards in the world.

Acknowledgments

This project is funded by the U.S. Department of Housing and Urban Development (HUD)—Project Award No. H-21682 CA, and the authors gratefully acknowledge that funding. The content in this article reflects the views of the authors and does not necessarily reflect the views of HUD. The authors also acknowledge contributions from Benjamin Hayes and Milad Roohi and thank Jagruti Rekhi for managing and coordinating this work on HUD's behalf. Finally, the authors thank the editors and two referees for their helpful comments.

Authors

John W. van de Lindt is the Harold H. Short Endowed Chair Professor at the Department of Civil and Environmental Engineering at Colorado State University. Maria Koliou is an assistant professor at the Zachry Department of Civil and Environmental Engineering at Texas A&M University. Pouria Bahmani is an assistant professor at the Department of Civil and Environmental Engineering at Washington State University.

References

- Alig, Ralph J., Jeffrey D. Kline, and Mark Lichtenstein. 2004. "Urbanization on the US Landscape: Looking Ahead in the 21st Century," *Landscape and Urban Planning* 69 (2): 219–234.
- American Society of Civil Engineers (ASCE). 2022. *Minimum Design Loads for Buildings and Other Structures (ASCE Standard ASC/SEI 7-22)*. Reston, VA: ASCE.
- Ceccotti, Ario. 2008. "New Technologies for Construction of Medium-Rise Buildings in Seismic Regions: The XLAM Case," *Structural Engineering International* 18 (2): 156–165.
- Dujic, Bruno, Simon Aicher, and Roko Zarni. 2006. "Racking Behavior of Light Prefabricated Cross-Laminated Massive Timber Wall Diaphragms Subjected to Horizontal Actions," *Otto Graf Journal* 17: 125–142.
- Federal Emergency Management Agency (FEMA). 2009. *Quantification of Building Seismic Performance Factors (FEMA P695)*. Washington, DC: FEMA.
- Hayes, B. N. 2021. *Experimental and Analytical Assessment of Internal and Panel-to-Floor Connectors for Cross Laminated Timber (CLT) Balloon-Style Construction*, Master of Science Thesis, Texas A&M University, College Station, TX.

Hristovski, Viktor, Bruno Dujic, Marta Stojmanovska, and Violeta Mircevska. 2012. "Full-Scale Shaking-Table Tests of XLam Panel Systems and Numerical Verification: Specimen 1," *Journal of Structural Engineering* 198 (11): 2010–2018.

Okabe, Minoru, Motoi Yasumura, Kenji Kobayashi, Takeshi Haramiishi, Yo Nakashima, and Kazuhiko Fujita. 2012. "Effect of Vertical Load Under Cyclic Lateral Load Test for Evaluating Sugi CLT Wall Panel." Paper presented at World Conference on Timber Engineering, New Zealand Timber Design Society, Auckland, New Zealand, July 16–19.

Pei, Shiling, John W. van De Lindt, Marjan Popovski, Jeffrey W. Berman, J. Daniel Dolan, James Ricles, R. Sause, Hans-Erik Blomgren, and Douglas R. Rammer. 2016. "Cross-Laminated Timber for Seismic Regions: Progress and Challenges for Research and Implementation," *Journal of Structural Engineering* 142 (4): E2514001.

Popovski, Marjan, and Igor Gavric. 2015. "Performance of a 2-Story CLT House Subjected to Lateral Loads," *Journal of Structural Engineering* 142 (4): E4015006.

Popovski, Marjan, Johannes Schneider, and Matthias Schweinsteiger. 2010. "Lateral Load Resistance of Cross-Laminated Wood Panels." Paper presented at World Conference on Timber Engineering, Auckland, New Zealand, July 16–19.

Tsuchimoto, Takahiro, Naohito Kawai, Motoi Yasumura, Tatsuya Miyake, Hiroshi Isoda, Chihiro Tsuda, Sota Miura, Satoshi Murakami, and Takafumi Nakagawa. 2014. "Dynamic and Static Lateral Load Tests on Full-Sized 3-Story CLT Construction for Seismic Design." In *World Conference on Timber Engineering (WCTE 2014)*, edited by A. Salenikovich. Red Hook, NY: Curran Associates.

United Nations Economic Commission for Europe/Food and Agriculture Organization of the United Nations (UNECE/FAO). 2017. "Forest Products Annual Market Review 2009–2010." Geneva Timber and Forest Study Paper 25. Geneva: UNECE/FAO Forestry and Timber Section.

van de Lindt, John W., M. Omar Amini, Douglas Rammer, Philip Line, Shiling Pei, and Marjan Popovski. 2020. "Seismic Performance Factors for Cross-Laminated Timber Shear Wall Systems in the United States," *Journal of Structural Engineering* 146 (9): 04020172. doi.org/10.1061/(ASCE)ST.1943541X.0002718.

Designing for Natural Hazards: Resilience Guides for Builders and Developers

John B. Peavey
Nay B. Shah
Chinedu Moneke
Kevin Kauffman
Elina Thapa
Home Innovation Research Labs

Abstract

Home Innovation Research Labs (Home Innovation) proposed to the U.S. Department of Housing and Urban Development a research project to create a set of practical, actionable guidelines for builders and developers to follow in the design and construction of residential buildings, neighborhoods, and accessory structures in a manner that could improve residential resilience and integrate resiliency throughout an entire community. The Designing for Natural Hazards guides accomplish that task by providing technical content in a straightforward manner that is easy for laypeople to understand. They also offer references so design professionals, builders, developers, and public officials can dive more deeply into the necessary details. The guides are segmented into five volumes, each focusing on a specific natural hazard type: wind, water, fire, earth, and auxiliary. The guides differ from other resiliency programs and resources because they do not constitute a prescriptive program or suggest lists of improvements. Instead, the resilience guides are designed to be flexible and thereby let a user focus on either a single resilient construction practice or multiple resilient construction practices, depending on the user's specific needs.

This article introduces the idea of prioritizing resilient construction practices based on the frequency of occurrence for any given natural hazard event. The authors also analyzed damage recorded in post-disaster field reports and insurance industry data (such as predictive modeling results).

Introduction

According to Munich Re, one of the world's largest multinational reinsurance companies, in 2021, natural disasters caused overall losses of \$280 billion in the United States, of which only \$120 billion was insured (Munich Re, 2022). Moreover, on the basis of analyses of 50 years of historical data, Munich Re estimates that losses related to natural disasters have been trending upward. As the frequency and severity of natural disasters increase, many insurance companies are leaving high-risk markets in Florida (Rozsa and Werner, 2022) and California (Scism, 2022), where property losses have greatly increased.

In 2021, the federal government declared 20 major natural disasters and allocated supplemental spending for disasters totaling approximately \$145 billion (Smith, 2022). The U.S. Department of Housing and Urban Development (HUD) plays a major role in disaster recovery efforts through the Community Development Block Grant program (CDBG—Disaster Recovery Assistance). HUD's interest in minimizing property losses is reflected in the size of its Federal Housing Authority-insured portfolio, which consists of “76 million single-family insured loans, 11,213 multifamily insured loans [1,405,260 units], 3,825 residential healthcare facilities, and 88 hospitals with \$1.2 trillion, \$111 billion, \$33 billion, and \$6.3 billion, respectively, of mortgage balances [as of June 30, 2021]” (HUD, 2021).

As the frequency and severity of natural disasters increase, the Federal Emergency Management Agency (FEMA) and the U.S. insurance industry have emphasized the importance of hazard-resistant building codes. FEMA's 2020 *Building Codes Save: A Nationwide Study* estimated that adopting “hazard-resistant building codes” minimizes property losses (FEMA, 2020). Nonetheless, local jurisdictions must adopt current building codes with hazard-resistant provisions to achieve those avoided losses. Verisk, a property and casualty insurance company, rates building code adoption across the country by using its Building Code Effectiveness Grading Schedule (BCEGS) to assess “the community's building codes and their enforcement, with special emphasis on mitigation of losses from natural hazards. Municipalities with well-enforced, up-to-date codes should demonstrate better loss experience, which can be reflected in lower insurance rates. The prospect of lessening catastrophe-related damage and ultimately lowering insurance costs provide an incentive for communities to enforce their building codes rigorously—especially as they relate to windstorm and earthquake damage” (Thomure, 2022).

The average BCEGS rating countrywide is 4 out of 10 (with 1 being the best grade and 10 being the worst; see exhibit 1) (Verisk, n.d.). The data are available for most states but not all because some do not participate in the program.

Exhibit 1

BCEGS Rating Countrywide (USA)

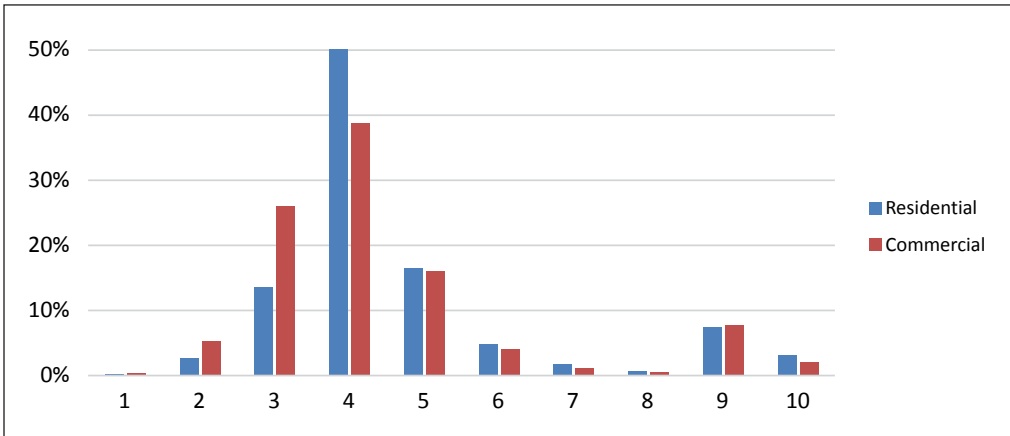

Source: Verisk, n.d.

Building codes generally establish minimum construction requirements for reasonable levels of safety, public health, and general welfare for property and its occupants. Building codes get improved at various times on the basis of damage data from natural disasters or other building performance data, such as structural failures and fires. For example, after Hurricane Michael in 2018, the American Society of Civil Engineers (ASCE) updated its *ASCE/SEI 7-22 Minimum Design Loads and Associated Criteria for Buildings and Other Structures* (ASCE, 2021) to reflect new structural design requirements. The new minimum design requirements are typically referenced by the next version of the building code.

Two challenges remain with regard to building codes. First, rates of adoption of building codes vary across the country, with many states and local jurisdictions lagging behind the most current versions of model building codes. FEMA tracks building code adoption across the country and identifies through its interactive portal the versions of the building code that are in use (FEMA, 2022b). Verisk publishes its BCEGS rating, which captures code adoption, plan review, and inspection practices for a given jurisdiction. Both metrics show that certain areas of the country lag far behind in adopting the most current building codes. Second, many experts say that construction practices must be above minimum building code requirements to improve building resilience. The National Institute of Building Sciences and the Insurance Institute for Business & Home Safety have recommended using code-plus programs (IIBHS, 2016) for disaster resistance in buildings. HUD created the Disaster Recovery Tool Kit (HUD PD&R, n.d.), which is designed for property owners that are rebuilding after a disaster.

HUD has a Climate Action Plan, with increasing climate resilience as its first goal (HUD, 2021). The current Home Innovation research project contributes to that goal by developing design guides that builders and developers can consult before a natural disaster or in response to a major rebuilding effort after a natural disaster. The *Designing for Natural Hazards* guides focus on new construction and major reconstruction after natural disasters—especially reconstruction in areas

where entire communities must be rebuilt after catastrophic events. The guides are not intended for minor repairs or renovations that are common after typical natural disaster events, and they do not cover commercial buildings, although many of the identified construction practices are also applicable to multifamily mixed-use buildings with wood framing.

To make the resilience guides as practical as possible, with as much input and buy-in as possible, Home Innovation assembled a Technical Advisory Group (TAG) by recruiting a balanced number of stakeholders—approximately the same numbers of users, producers, and public interest participants—to reach consensus on an approach to the development of content for the guides. The TAG was organized into five task groups based on the five natural hazard categories: wind, water, fire, earth, and auxiliary. The task groups met monthly to develop the content of the guides. In addition, all task group meetings were open to the public, and input was solicited beyond the members of the TAG and its task groups.

The *Designing for Natural Hazards* guides provide comprehensive information on a broad range of natural hazard types. Exhibit 2 shows the diversity of natural hazard events in the United States in 2021 (Smith, 2022) below. Note that each guide within the *Designing for Natural Hazards* series provides specific construction details to minimize property loss.

Exhibit 2

U.S. 2021 Billion-Dollar Weather and Climate Disasters

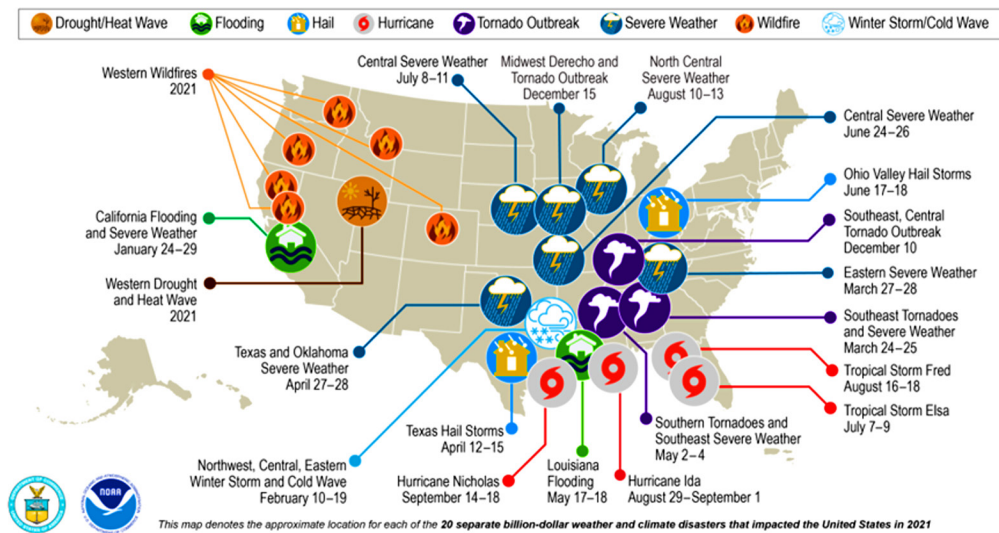

Source: National Oceanic and Atmospheric Administration, National Centers for Environmental Information. NOAA National Centers for Environmental Information (NCEI) U.S. Billion-Dollar Weather and Climate Disasters (2022). <https://www.ncei.noaa.gov/access/billions/>; DOI: 10.25921/stkw-7w73

For local jurisdictions that have not adopted the most current building codes, the guides are valuable because they can be used to improve construction practices beyond what older building codes require. For builders and developers seeking above-code guidance, the *Designing for Natural*

Hazards guides identify ways to design above requirements even for current building codes—similar to a code-plus approach.

The TAG used damage data from natural hazard reports and risk assessment data from companies that compile such information for the insurance industry so it could prioritize construction practices within the *Designing for Natural Hazards* guides. The TAG understood that funding to improve construction resilience may be limited, so the group prioritized construction practices on the basis of high-frequency damage observed after events. Such an approach encourages users of the guides to select and implement construction practices that minimize the kinds of damage that are most common and costly to repair.

The resilience guides are not intended to substitute for engineering or architectural project design work; instead, the technical guidance within them identifies the kinds of components that builders can enhance or improve to achieve above-code performance. When those enhancements and improvements get implemented, the resiliency of residential buildings and other community assets, such as utilities and defensible spaces, should also improve.

How to Use the Resilience Guides

At the start of the project, Home Innovation asked builders that wanted to participate in the Technical Advisory Group whether they were familiar with existing resilience resources and whether they used those resources. Builders familiar with resilience resources—such as technical reports, resilient-building programs, and resilience tool kits for residential buildings—said that the resources were difficult to use because they lacked construction details and descriptions of the kinds of damage they would minimize. Those missing components then became a primary objective of the project: to deliver technical guidance in an easy-to-use manner that is accessible to a wide range of stakeholders.

The *Designing for Natural Hazards* guides are meant to be used by that wide range of stakeholders: design professionals, builders, developers, realtors, and even prospective homebuyers. The *Designing for Natural Hazards* guides differ from other resiliency programs and resources because they are not prescriptive programs and do not contain lists of improvements. Instead, the resilience guides are designed to be flexible and to let a user focus on either a single resilient-construction practice or multiple resilient-construction practices depending on the user's specific needs.

Each one-pager contains key information about the specific natural hazard and resilient construction practices that would minimize or eliminate potential damage. The front of each document (1) identifies the damage expected by the hazard, as shown in a photo; (2) gives the frequency with which a specific type of damage occurs; (3) shows a description of the resilient-construction practice that can minimize damage; (4) describes the mitigation strategy; and (5) offers a summary of the costs and benefits of implementing the resilient-construction practice (exhibit 3).

Exhibit 3

Sample Front Page

VOLUME 3: FIRE

DESIGNING FOR NATURAL HAZARDS
A RESILIENCE GUIDE FOR BUILDERS & DEVELOPERS



Wildfire damage to a housing development.

DEFENSIBLE SPACE

The proximity of fire-ready fuels—including landscaping, fencing, and other combustible materials—close to the home creates a vulnerability to ignition during wildfire events. A defensible space is an area around a building in which vegetation, debris, and other types of combustible fuels have been treated, cleared, or reduced to slow or stop the spread of wildfire and help protect the home from catching fire (either from embers, direct flame contact, or radiant heat). Embers can travel long distances from burning forested areas into developments. If those embers ignite fuels close to the home, the danger of total loss is high, and the danger of wildfire for the neighborhood is also high. Creating a defensible space is one of the most cost-effective ways to protect a building from wildfire and often can be created. Good defensible space also provides firefighters a safe area in which to work to defend homes.

Damage Frequency
HIGH

Construction Practice
Establishing defensible space by reducing fire-ready fuels near the home can be part of the initial build or a remodeling project.

Mitigation Strategy
Remove combustibles from around the building. Use hardscapes and succulents in the first 5 ft. Plan landscaping to decrease the density of trees and shrubs near structures.

Cost & Benefit
Cost range to implement: \$–\$\$
Benefit: Defensible space reduces fire-ready fuels close to the building and can prevent ignition. Newer research shows that the first 5 ft. around the perimeter is critical.

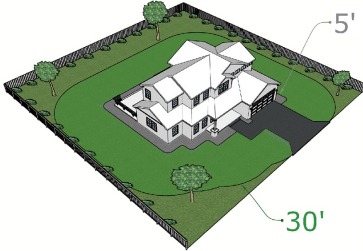

FIRE | 5

Source: Home Innovation Research Labs, forthcoming

The document provides additional design guidance details: (1) multiple design variations and supplemental resilient-construction practices, (2) the corresponding level of difficulty associated with the implementation of alternative resilient-construction practices, (3) the relative costs of implementation of the various options, and (4) technical references that have more information for each design option.

Exhibit 4

Sample Back Page

GUIDANCE	DIFFICULTY	COST
Use hardscapes and succulents for the landscaping within the first 5 ft. of the building. [1,2]	Easy	\$
For forested areas, when developing a community: thin trees and shrubbery within the community to provide 30 ft. of defensible space for each structure. [1,2]	Moderate	\$\$
Establish a means of annual landscaping maintenance within the neighborhood association to refresh defensible space. [1,2]	Complex	\$\$\$
Use noncombustible fencing within the first 30 ft. of the building, and include provisions in the neighborhood association covenants stating this requirement for future fencing installations. [3,4]	Easy	\$
Ensure that accessory buildings are more than 30 ft. away from the main structure, and incorporate separation distance provisions in the neighborhood association covenants. [5,6]	Easy	\$
Zoning can be used to cluster development into defensible areas and keep development away from fire hazards, such as steep slopes, where fires are difficult to contain. Develop green zones, parks, water retention, or roadway infrastructure as fire breaks. Incorporate multiple ingress and egress planning as part of evacuation planning. [7]	Complex	\$\$\$

RESOURCES

1. [Chapter 7A, 201A-5 Materials and Construction Methods for Exterior Wildfire Exposure, 2019 California Building Code.](#)
2. [Section 603, Defensible Space, 2021 International Wildland-Urban Interface Code \(IWUIC\).](#)
3. [Preparing Homes for Wildfire \(NFPA.org\), National Fire Protection Association.](#)
4. [How to Prepare Your Home for Wildfires, National Fire Protection Association.](#)
5. [Wildfire Ready \(Disaster.org\).](#)
6. [Wildfire Ready: Home Preparedness Guide \(Disaster.org\).](#)
7. [Protect Your Home & Property from Wildfire \(cfs.colostate.edu\), Colorado State Forest Service.](#)

6 | FIRE HUD.GOV

Source: Home Innovation Research Labs, forthcoming

Because the resilient-construction practices summarized in the guides are intended to be implemented in areas where building codes do not specify such practices, builders cannot rely on a building code official to verify that the practices have been followed. Therefore, builders that undertake those resilient-construction practices will have to either incorporate the practices into their internal quality assurance processes or hire third-party organizations to confirm that the resilient-construction practices were appropriately included in the design and constructed per their specifications, which requires additional detail beyond the one-pagers.

Identifying Resilient Construction Based on Natural Hazard Types

Each task group was assigned to develop a specific volume of the *Designing for Natural Hazards* series. The task group's first undertaking was to identify typical damage that results when natural hazard events occur. To that end, each task group reviewed technical reports related to major natural disaster events so it could identify the most relevant resilient construction content to be included in its one-pager.

Wind

The Wind Task Group identified damage that occurs from various windstorms, including the most common types: thunderstorms, microbursts, tornadoes, hurricanes, cyclones, haboobs, and derechos. The National Oceanic and Atmospheric Administration (NOAA) defines damaging winds as those that exceed 50 to 60 miles per hour, which includes thunderstorm, straight-line, and tornado winds. The Wind Task Group did not distinguish the cause of wind damage because wind damage can occur from a wide range of weather phenomena, and insurance companies generally handle claims the same way.

Water

The Water Task Group considered the damage that occurs from flooding or wind-driven rain. FEMA defines flooding as “a temporary overflow of water onto land that is normally dry. It is the most common natural disaster in the United States. [Floods] result from rain, snow, coastal storms, storm surge, and overflows of dams and other water systems.” FEMA defines wind-driven rain as “rain [that] is propelled into a covered structure by wind, that is considered wind-driven rain and is not covered under your flood insurance policy.” The group focused on both flooding and wind-driven rain as natural hazards. The practices in the water-resilient construction guide improve construction in moderate- to low-risk flood zones and can be implemented incrementally by adding one or more flood-resilient features to a building. Because hurricanes and other major storms may lead to damage caused by wind-driven rain, the Water Task Group identified construction practices that improve the performance of roofs, windows, and doors.

Fire

The Fire Task Group studied damage that occurs from wildfires, defined by FEMA as “an unplanned, unwanted fire burning in a natural area, such as a forest, grassland, or prairie. Wildfires can start from natural causes, such as lightning, but most are caused by humans, either accidentally or intentionally.” The Fire Task Group focused on wildfires that occur as natural hazards, not accidental fires—such as from cooking, equipment, and smoking—and not on arson inside a residential building. Wildfires generally burn the exterior of a building due to direct contact with flames, wind-blown embers landing on the building, or extreme radiant heat that causes flammable chemicals or materials to combust. Resilient-construction practices that minimize damage from wildfires focus primarily on removing fuel around a building using fire-resistant landscape design and using fire-resistant building materials for both the building envelope and outdoor living features, such as decks and fencing.

Earth

The Earth Task Group analyzed typical damage that happens when earthquakes or other ground disturbances occur. Such disasters can occur from various events, including the most common types: earthquakes, landslides, mudslides, soil dynamics, sinkholes, and freeze and thaw heaving. FEMA defines an earthquake as “a sudden release of energy that creates a movement in the Earth’s crust.” The group reviewed case studies and field reports of earthquake events, such as the Alaska Earthquake of November 30, 2018, published by FEMA, and the Northridge, California,

Earthquake of January 17, 1994, published by HUD. The group discussed the damage described in the reports and then reviewed a wide range of technical resources to identify resilient-construction methods that could minimize earth-related damage. Per FEMA, “Most earthquake-related property damage and deaths are caused by the failure and collapse of structures due to ground shaking. The level of damage depends upon the extent and duration of the shaking. Other damaging earthquake effects include landslides, the down-slope movement of soil and rock (in mountain regions and along hillsides), and liquefaction.” The Earth Task Group focused primarily on damage caused by earthquakes and considered other earth-related hazards secondary because many are driven by other natural hazards. For example, a mudslide can occur after an extended drought followed by a period of heavy rain or after an earthquake.

Auxiliary

The Auxiliary Task Group focused on hazards that do not fit within the wind-, water-, fire-, or earth-related categories. The major auxiliary hazard covered in the guide is volcano-related damage, but extreme cold, extreme heat, and hail are also included because they were not covered in the wind or water guides. The United States Geological Survey (USGS) says, “[Volcanic] eruptions often force people living near volcanoes to abandon their land and homes, sometimes forever. Those living farther away are likely to avoid complete destruction, but their cities and towns, crops, industrial plants, transportation systems, and electrical grids can still be damaged by tephra, ash, lahars, and flooding.” FEMA has provided mitigation and prevention guidance for damage from cold waves in the form of freezing pipes and snow loads; heat waves in the form of pressure on the power grid and loss of power; and hail, which damages roofs and sidings. The Auxiliary Task Group identified the typical damage that results when volcanoes, cold waves, heat waves, and hail occur. The task group reviewed case studies of volcano hazard events, such as the recent eruption of Kilauea in Hawaii on May 3, 2018, published by FEMA. The task group then discussed the damage described in the report and reviewed a wide range of technical resources to identify the most relevant resilient-construction content.

Identifying the Frequency of Damage Types

After familiarizing themselves with the specific kinds of damage caused by various natural hazards, each task group was asked to determine the type of damage most likely to occur when one considers all possible kinds of damage. That task proved challenging because damage data are difficult to collect for three reasons: (1) Insurance-related claims data are proprietary, and a portion of the damage is covered by the building owner’s insurance. (2) Forensic field reports are generally available only for major natural hazard events; they are not compiled for every natural hazard event that occurs. (3) Only limited data are available for natural hazard events that rarely occur.

Wind

The Wind Task Group was fortunate to have several sources of data, such as information from Auburn University’s Structural Extreme Events Reconnaissance (StEER) program. StEER focuses on collecting representative datasets for each hazard event by sampling from clusters of similar structure types—such as single-family residential and commercial—across the hazard gradient and

by sampling at regularly spaced intervals within the clusters, such as every other or every third structure. StEER provided the damage frequency data in exhibit 5, which focuses on the primary building components with visible exterior damage, stratified by hazard intensity and structure occupancy. Damage to large door openings was calculated using only structures that contained large door openings; as a result, the sample size was smaller.

StEER evaluates structural damage caused by hurricanes, tornadoes, other wind events, earthquakes, and tsunamis. StEER does not investigate wildfires or flood-related damage.

Exhibit 5

Sample Frequency of Wind Damage Data to Single-Family Homes

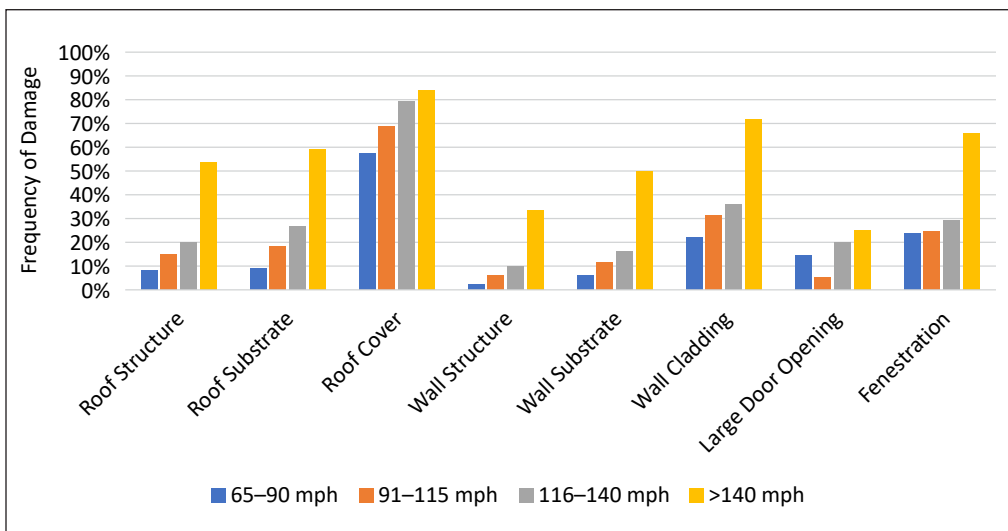

Source: Structural Extreme Events Reconnaissance (StEER) program compiled for Home Innovation

Water

The Water Task Group did not have access to damage data, but the group reviewed various tools provided by FEMA that estimate the costs of water damage caused by flooding. The risk of flooding is generally based on flood zones and maps, but predicting where a flooding event will occur is impossible. FEMA states, “Flood hazards change over time. Updated flood maps provide a more accurate picture of a property’s flood risk. To better reflect your current flood risk, the National Flood Insurance Program (NFIP) and the Federal Emergency Management Agency (FEMA) use the latest technology and data to update flood maps nationwide.” USGS “provides information about the magnitude and frequency of floods based on records of annual maximum instantaneous peak discharges. The information is in the form of a list of current USGS flood frequency reports published by state” (USGS, 2021). The Water Task Group gathered reports and discussed the water damage described therein; then, it reviewed a wide range of technical resources—for example, resources from FEMA, HUD, ASCE, the International Code Council, and the Insurance Institute for Business & Home Safety. Using that information, the task group identified damage types and estimated frequencies of occurrence.

Fire

The Fire Task Group considered wildfire hazards limited to low-density developments. Areas with medium- and high-density developments—which typically add fuel once a wildfire spreads—were not considered. Neither did the group consider how firefighting can mitigate the spread of wildfire. Instead, the guidance focuses strictly on methods of improving the fire resistance of individual homes.

Determining the frequency and type of fire damage is difficult because, unlike other natural hazards, when fire damage occurs due to wildfires, the structure is generally a total loss. The dynamics of wildfires are complex because they depend on many factors, such as wind, terrain, fuel ignition potential, the density of vegetation, building structures, the size and intensity of the fire, and firefighting. Historically, insurance companies have modeled risk for many natural hazards, including wildfires, but they have found that many historical models no longer capture the current risks of wildfires or the resulting damage or losses. That realization has led risk management companies such as Risk Management Solutions, Verisk Analytics, and Zesty.ai to develop new predictive wildfire-modeling tools. In some cases, insurance companies are partnering with those companies to develop improved models.

During the project, the Fire Task Group received fire-modeling data from Zesty.ai, a company specializing in data analytics for natural hazards that has developed new, predictive fire-modeling tools for the insurance industry, including its Z-FIRE modeling and scoring tool (Zesty.ai, 2022). Zesty.ai collects satellite data for determining the defensible space, vegetation types, and roofing types for buildings in an area that may be at risk of wildfires. Such metrics can help insurers build better predictive fire models and better assess the risk of houses being damaged or lost during a wildfire. Modeling based on post-event fire data may not fully capture structural-fire behavior because the models lack the influence of defensive firefighting activities. Fire propagation is further confounded by the fact that buildings themselves add to the fuel, and such a consideration is not captured in the predictive models.

With those limitations in mind, the Fire Task Group reviewed the data provided by Zesty.ai along with other guidance from FEMA, the California Department of Forestry and Fire Protection, and the U.S. Department of Agriculture's Forest Service to determine that defensible space and fuel management was well correlated with better outcomes for low-density developments. From the data available, the Fire Task Group could not determine which elements of the building envelope—roof, gutters, decking, and the like—were more vulnerable to embers than other elements. However, the Insurance Institute for Business & Home Safety research has shown that vented roofs and soffits can be improved with ember-resistant features. On the basis of a review of available post-wildfire damage data and judgment by the Fire Task Group, those data were used to identify the frequency of each specific type of damage from wildfires. More detailed wildfire forensics could lead to the use of better metrics to identify which house components are more likely to contribute to the loss of a building structure.

Earth

The Earth Task Group had to infer the frequency of damage from technical reports, FEMA's *Homebuilder's Guide to Earthquake-Resistant Design and Construction*, and mitigation programs.

Although the StEER network investigates and publishes technical reports after earthquake events, the damage data available are not as extensive as the network's wind hazard data because earthquakes do not often occur in the United States.

After the Ridgecrest, California, earthquakes of July 4 to 5, 2019, StEER published a preliminary virtual reconnaissance report documenting the damage observed. The executive summary of the report states, "The impact of the two earthquakes on the city of Ridgecrest demonstrated its resiliency as it recovered rapidly where many restaurants and gas stations are back up and running. There was very little structural damage, even from the second, stronger (M 7.1) earthquake, except for the typically vulnerable buildings (e.g., unreinforced masonry structures and mobile homes). However, there were substantial non-structural and content losses. The other city that was impacted the most is Trona, which did not perform as resiliently as Ridgecrest, where the city remained dysfunctional up to the time of writing this report. There were more damaged structures, mostly from the effects of ground failure and possibly strong site response related to soft sediments. The town suffered from significant loss of water where its main water pipes fractured due to fault rupture and lateral spreads." The complexity of damage, as illustrated in the StEER report, varied on the basis of soil type, age of the building, type of construction, and magnitude of the earthquake.

Auxiliary

The Auxiliary Task Group had to infer from technical reports, FEMA's disaster preparedness documents, and other mitigation programs to establish the frequency-of-damage metric for volcanoes. The United States has five observatories—in Alaska, California, the Cascades, Hawaii, and Yellowstone—that monitor volcanic activities. USGS says that "scientists [at the observatories] also assess volcano hazards and work with communities to prepare for volcanic eruptions."

The areas in the United States with active volcanoes include California, Oregon, Washington, Alaska, Hawaii, American Samoa, and the Mariana Islands. Notable recent eruptions have threatened the health and safety of residents and have damaged property and infrastructure, according to USGS. For instance, in 2018, more than 700 structures were destroyed when swift-flowing lava erupted from fissures in Kilauea's lower East Rift Zone. Lava covered 35.5 square kilometers (13.7 square miles), which included houses, farms, wild spaces, roads, highways, and critical infrastructure. Kilauea is ranked the U.S. volcano with the highest threat score in the very-high-threat category.

In 2009, more than 300 airline flights were canceled and Anchorage International Airport shut down when Redoubt Volcano in southern Alaska erupted clouds of volcanic rock and ash. Redoubt ranks in the very-high-threat category.

Observatories can usually give surrounding areas notice before major volcanic eruptions occur. The damage would be catastrophic to buildings in the immediate vicinity of a volcanic eruption.

Prioritizing High-Frequency Damage for Resilience

The Technical Advisory Group recommended prioritizing high-frequency-damage areas of a building as the most practical mitigation strategy for resilience. Many worried that if hazard mitigation funding for above-code practices and strategies were limited or if a builder wanted to invest in one specific resilient-construction practice instead of others, knowing what was most important to do would be difficult without some level of prioritization.

Data about the frequency of damage type are necessary for builders and developers so they can prioritize the resilient-construction practices that would yield the greatest benefit—or the least amount of damage—to buildings. Damage-frequency metrics on the one-pagers are intended to provide builders and developers with a general idea of the frequency and severity of possible damage so that cost alone does not drive the mitigation strategy.

Assessment or reconnaissance reports provide some guidance, but given the complexity of the damage observed after different types of natural hazards, additional, detailed forensics data after events are needed to develop a more accurate method of prioritizing damage types. During the project, task groups relied on their collective judgment and expertise when determining how to classify high-, moderate-, and low-frequency damage.

Implementing Resilient-Construction Practices

The task groups believed that licensed design professionals and subject matter experts would be able to prioritize resilient-construction practices without much guidance. However, given the myriad options and design alternatives on the one-pagers, they recommended that bundling multiple one-pagers would be valuable so that a builder or developer could offer a prepackaged system of resilient-construction practices, similar to other resiliency programs.

The most basic prepackaged system of resilient-construction practices could be as simple as selecting all the high-frequency one-pagers to improve the areas where damage is most likely to occur. Each task group explored a good-better-best approach to grouping the one-pagers, whereby basic levels of resilience would be branded as good; more advanced practices could be combined with those basics to offer a better option; and the most comprehensively resilient practices could be considered the best level of resilience.

A builder or developer could also focus on implementing just one or two resilient-construction practices and could provide customers with the one-pager. Certain resilient-construction practices may be considered alternatives, whereas others may be additional practices to be implemented. By emphasizing the unique possibility of customization, the *Designing for Natural Hazards* resilience guides offer a wide range of solutions—from the good-better-best approach to a single area of improvement that a builder or developer could consider.

Next Steps: The Future of Resilience

As resilient-construction practices evolve, the one-pagers in the series' various guides should be updated to reflect improvements or modifications. For damage-frequency metrics to improve, additional data are needed from post-disaster forensic reports, FEMA's National Flood Insurance Program, and the insurance industry's proprietary claims data. The aggregation and anonymization of insurance claims data could help improve building codes and identify where damage occurs the most. Moreover, organizations like the StEER network should expand their work in post-disaster field assessment and consider including other disaster events in the areas of investigation. For instance, StEER network wind damage data should serve as a model for ways to capture and catalog damage-frequency information.

Damage data should be shared widely with the building products industry to spur improvements in building materials and construction methods. The authors did not study new products and whether they improved resilience because such a study was beyond the scope of work, but new and better products are potential resilience solutions. For example, paying a premium up front for a better wall-sheathing product could avoid the added cost of major renovation and replacement of water-damaged building materials in the future.

Better predictive-modeling tools are essential for estimating the locations and risks of flooding and wildfire hazards. FEMA maintains flood maps and related cost modeling to estimate the costs of repairing flood damage (FEMA, 2022a). The Wildland Urban Interface (WUI) maps are important for determining areas at risk of wildfire damage (U.S. Fire Administration, n.d.). The maps and risk areas can change over time with regard to both flooding and wildfire hazards. Therefore, builders and developers should consider resilience as above-code construction practices that minimize damage from natural hazards in areas where the risk is low or moderate.

The Fire Task Group discussed methods of preventing smoke damage and improving indoor air quality during a wildfire by employing a special clean room designated within a building, but those methods were not included in the resilient guide because they require further research or field validation. Although the techniques discussed seemed technically sound, the group was reluctant to recommend one-pagers on resilient-construction practices that have not yet proven effective. However, most buildings that have survived wildfires with little fire damage have suffered major smoke damage.

Although this research project focused on new construction, the existing housing stock is at greater risk of damage than new buildings because of greater numbers and more inventory. In a few reconnaissance reports, StEER has discussed correlating damage data and year of construction to illustrate whether a building code has improved house performance over time. The data for earthquake events are not as comprehensive as for wind events, and the data do not identify specifically whether an existing building was retrofitted to improve earthquake performance before an earthquake event occurred. Such data should be collected and analyzed to demonstrate the efficacy of retrofit programs and to learn whether the above-code construction practices improve building outcomes after natural hazard events occur.

The Auxiliary Task Group recommended that the definition of resilience be expanded to include the health and safety of the building occupants—beyond the structure of the building itself. Because the research project was conducted during the COVID-19 pandemic, the task group felt compelled to consider safety in terms of biohazards, such as airborne viruses, and how they can be circulated through a heating, ventilation, and air-conditioning system. Although the scope of this research project did not allow an opportunity to address biohazards, biohazard is a valid area for future research. Either the topic could be included within the auxiliary guide, or a new biohazard guide could be created for occupant resilience in buildings.

Conclusion

As climate change drives more extreme weather events and the severity of damage to housing increases, many communities will want to rebuild using the above-code construction practices that are resilient and easy to implement. The *Designing for Natural Hazards* series offers solutions that residential designers, builders, and developers can readily incorporate into their business practices, focusing on minimizing high-frequency damage while providing a wide range of solutions. The guide can also be integrated into existing sustainability programs by offering new resilience options to complement green building practices. *Designing for Natural Hazards* can be a precursor to developing a new resilience standard focused on residential buildings. The standard would be an above-code program shaped by insurance data, damage assessments, and better modeling of natural hazards.

Acknowledgments

The authors gratefully acknowledge the financial support provided by the U.S. Department of Housing and Urban Development (HUD) for this research under grant number H-21673 CA. Further, we thank Mike Blanford for managing and coordinating this work on HUD's behalf. Finally, the authors thank the editors and two referees for their helpful comments.

The *Designing for Natural Hazards* resilience series was developed by a group of dedicated subject matter experts, who provided their time and expertise for 2 years. We thank the Technical Advisory Group for leadership, commitment, and contributions to the project—even as we weathered the challenges of a pandemic.

The Technical Advisory Group includes *GUIDE USERS* Randy Noel, MIRM, chair of the Technical Advisory Group; Anne Anderson, SE; Heather Anesta, PE, SE; Illya Azaroff, FAIA; Dr. Henry Burton, SE; Matthew Cooper, PE; Andrew Kollar, AIA; Darlene Rini, PE; James Williams, AIA, PE, SE; *PRODUCERS OF BUILDINGS AND SUBJECT MATTER EXPERTS* Francis Babineau, PE; Daniel Buckley; Michael Chandler; Julia Donoho, AIA, Esq.; Michael Funk; Maria Hernandez; Elizabeth Miller; William Sanderson; Lisa Stephens; Frank Thompson; Dr. Theresa Weston; and *PUBLIC INTEREST STAKEHOLDERS* Dana Bres, PE; Nicholas Crossley; Melissa Deas; Greg Grew, AIA, CBO; Dr. Therese P. McAllister, PE; Amanda Siok; Dana Sjostrom, CFM; Nancy Springer, CBO; Kristopher Stenger, AIA; Russell Strickland; and Meghan Walsh, AIA.

Authors

John B. Peavey, PE, is the director of building science at Home Innovation Research Labs. Nay B. Shah, PE, is a research engineer at Home Innovation Research Labs. Chinedu Moneke, PE, is a research engineer at Home Innovation Research Labs. Kevin Kauffman is a research engineer at Home Innovation Research Labs. Elina Thapa is a research engineer at Home Innovation Research Labs.

References

- American Society of Civil Engineers (ASCE). 2021. "Newly Updated Minimum Design Loads and Associated Criteria for Building and Other Structures, ASCE/SEI 7-22 Standard Now Available." News release. Reston, VA: ASCE.
- Federal Emergency Management Agency (FEMA). 2022a. My Flood Zone. Washington, DC: FEMA.
- . 2022b. National Building Code Adoption Tracking Portal: Third-Quarter 2022 Combined Hazards. Washington, DC: FEMA.
- . 2020. *Building Codes Save: A Nationwide Study*, November 2020. Washington, DC: FEMA.
- Home Innovation Research Labs. Forthcoming. *Designing for Natural Hazards a Resilience Guide for Builders & Developers, Volume 3: Fire*. Washington, DC: U.S. Department of Housing and Urban Development.
- Insurance Institute for Business & Home Safety (IIBHS). 2016. *Code-Plus Programs for Disaster Resistance*. August 2, 2016. Washington, DC: National Institute of Building Sciences.
- Munich Re. 2022. *Hurricanes, Cold Waves, Tornadoes: Weather Disasters in USA Dominate Natural Disaster Losses in 2021*. Munich: Munich Re.
- Rozsa, Lori, and Erica Werner. 2022. "Florida's Insurance Woes Could Make Ian's Economic Wrath Even Worse," *Washington Post*, September 30, 2022.
- Scism, Leslie. 2022. "Wildfire Risk in California Drives Insurers to Pull Policies for Pricy Homes," *Wall Street Journal*, January 19, 2022.
- Smith, Adam B. 2022. "2021 U.S. Billion-Dollar Weather and Climate Disasters in Historical Context." Silver Spring, MD: NOAA.
- Thomure, Dale. 2022. *Building Code Effectiveness Grading Schedule*. Jersey City, NJ: Verisk.
- U.S. Department of Housing and Urban Development (HUD). 2021. Climate Action Plan. Washington, DC: HUD.
- U.S. Department of Housing and Urban Development (HUD) Office of Policy Development and Research (PD&R). n.d. PD&R Disaster Recovery Tool Kit. Washington, DC: HUD PD&R.

U.S. Fire Administration. n.d. Wildfire and the Wildland Urban Interface (WUI). Featured Resources. Emmitsburg, MD: U.S. Fire Administration.

U.S. Geological Survey (USGS). 2021. *Flood Frequency Reports*. Washington, DC: USGS.

Verisk Analytics, Inc. n.d. Facts and Figures About BCEGS Grades Around the Country. Jersey City, NJ: Verisk. <https://www.isomitigation.com/bcegs/facts-and-figures/>.

Zesty.ai. 2022. "Leading Insurers Assess Wildfire Risk at the Property Level." San Francisco: Zesty.ai.

Modeling and Analyzing Distributed Heat Pump Domestic Water Heating in Modular Multifamily Buildings

Victor Braciszewski
Stet Sanborn
Justin Tholen
Harshana Thimmanna
SmithGroup

Tyler Pullen
Carol Galante
University of California, Berkeley
Turner Center for Housing Innovation

Jamie Hiteshew
Factory_OS

Abstract

The University of California (UC), Berkeley, Turner Center for Housing Innovation; SmithGroup; and Factory_OS examined the integration of a distributed 120-volt, shared circuit heat pump domestic water heating system in multifamily modular construction. The research team focused on hot water systems because of the high proportion of building energy used for water heating in multifamily apartment buildings in the United States (EIA, 2015); the distributed system focus was chosen for its potential to simplify standardized installation within volumetric modular housing construction practices. The study focused on two primary factors: (1) the energy performance of the distributed heat pump system relative to centralized natural gas and heat pump domestic water heating systems, and (2) the installation cost comparison between a centralized versus distributed heat pump domestic water heating system using modular construction methods. The energy modeling and analysis revealed that centralized heat pump domestic water heating systems in multifamily housing projects could offer 29-percent energy savings compared with traditional, natural gas-fired systems; furthermore, distributed heat pump water heater systems can save an additional 3 percent in energy use compared with centralized equivalents. Built using offsite modular construction techniques, the distributed heat pump hot water system adds an anticipated \$1,800 in per-unit installation costs compared with centralized systems without factoring in rebates and incentive programs. In-factory installation also provides potential benefits not captured in this estimate, including faster installation times and higher quality control to minimize onsite rework and maintenance (a common issue with traditional onsite installation), alongside electricity savings throughout a project's life cycle.

Introduction

The sustained rise in housing costs in many metropolitan areas across the United States reflects the severe shortage in housing production relative to the growing demand for more affordable housing options (Kingsella and MacArthur, 2022; Woetzel et al., 2014). Simultaneously meeting the demand for new housing across the country necessitates changes to homebuilding processes that minimize detrimental environmental impacts of new home construction over a building's life cycle, including embodied carbon and energy-efficient operation. Growing legislative momentum at local, state, and federal levels reflects this necessity, including the recent Inflation Reduction Act, which provides more than \$50 billion through various programs for sweeping building decarbonization across the United States (Jenkins et al., 2022). This research focuses on two primary design constraints for new housing: environmental impact reduction through energy efficient operations and affordable construction. The more acceptance of technologies, products, and processes that reduce the time, cost, and environmental impact of new housing, the more effectively the United States can address the dual challenges of housing affordability and climate change.

Without cost-saving processes and mechanisms to manage upfront construction costs, previous Turner Center analysis revealed that existing sustainability-focused building codes in California may inadvertently increase the cost of new housing construction by up to 4 percent (Reid, 2020). Without targeted intervention, continued expansion of well-intentioned, environmentally progressive codes pushing for further energy efficiency or full decarbonization (for example, net-zero buildings) may inadvertently increase the already-high costs of new housing construction (Raetz et al., 2020; Reid, 2020). Modular and other offsite construction methods respond to the urgent need to lower the cost and time required for housing development, especially in the multifamily market in dense metropolitan cores, where housing demand and construction costs are high (Bertram et al., 2019; Pullen, 2022). Several recent, overlapping studies from the National Renewable Energy Laboratory (NREL) and funded by the U.S. Department of Energy (DOE) found that modular construction is also uniquely positioned to incorporate resilient and energy-efficient design at reduced costs and with higher quality control, potentially providing more reliable performance over the life cycle of the building (Klammer et al., 2021; Pless et al., 2022; Podder et al., 2020).

This research builds on those and other studies to demonstrate the impact of incorporating distributed heat pump water heater (HPWH) technology into modular construction practices to meet the urgent, intersecting demands of future U.S. housing stock. Both technologies are relatively new or re-emerging in U.S. markets, according to existing studies (Pullen, 2022; Pullen, Hall, and Lessing, 2019) and the research team's interviews with housing industry professionals. Providing real expectations of the energy savings and cost impact of this integration helps developers and architects make informed decisions while balancing construction costs with increasingly ambitious building emissions targets.

The support of the U.S. Department of Housing and Urban Development (HUD) is instrumental for this research because HPWH and modular construction techniques have relatively low (but growing) adoption in the U.S. housing market, according to more than 20 person-hours of

interviews conducted by the research team. Although both technologies have higher adoption in other countries, such as Japan, Finland, and Sweden (Bertram et al., 2019; Manley and Widén, 2019), the U.S. context introduces novel risks, opportunities, and challenges (Pullen, Hall, and Lessing, 2019). Thus, government-funded research can assess the viability and potential of coordinated technological interventions such as modular construction and distributed HPWHs to encourage and mitigate the risk of early adopters. That support further improves confidence among industry practitioners and investors—including many of those interviewed—spreading familiarity, adoption, and knowledge sharing, which can ultimately accelerate the production of high-quality housing, built affordably and with minimal environmental footprint.

Research Design

To conduct the analysis, research collaborator SmithGroup provided several prototypical floor plans—for studio, one-bedroom, two-bedroom, and three-bedroom unit layouts—each with local 120-volt shared circuit HPWHs and drain water heat recovery (DWHR) units. The researchers developed the layouts, including plumbing piping and equipment, in the 3D building information modeling software Revit. Detailed energy models evaluated the relative energy performance of natural gas versus HPWH systems and centralized versus distributed HPWH systems. To test the results' sensitivity to climate, the researchers ran energy models using DOE's representative cities for the nine major climate zones in the United States.

Modular housing collaborator Factory_OS provided construction cost estimates for the domestic water heating schemes based on the detailed Revit models and current factory operational information. The distributed system costs were compared against a standard design for a centralized hot water system requiring field installation of the supply and recirculation piping. Future research steps will combine the construction cost information and energy cost data from the whole building energy modeling to provide a combined life-cycle cost assessment. Further analysis will include differences in expected construction duration between onsite and offsite methods and the expected development cost savings.

Technology and Product Review

This section introduces the construction method, mechanical systems, and design used in the study.

Modular Construction

Volumetric modular construction is a specific method of offsite and industrialized construction that brings a substantial portion of construction work (as much as 90 percent of total construction value in some cases) into a controlled factory environment. This method often consists of major structural, mechanical, plumbing, and electrical work, incorporated into a full 3D “box” that is then transported to and placed on site. The module can be self-contained to comprise an entire apartment unit (such as a small studio), or several modules can be connected on site to create larger apartment units. See exhibits 1–6 for examples of modular construction processes in Factory_OS's facilities in Vallejo, California, and exhibit 7 for an example of how multiple modules combine to form a two-bedroom unit.

Exhibit 1

Factory_OS Assembly Line

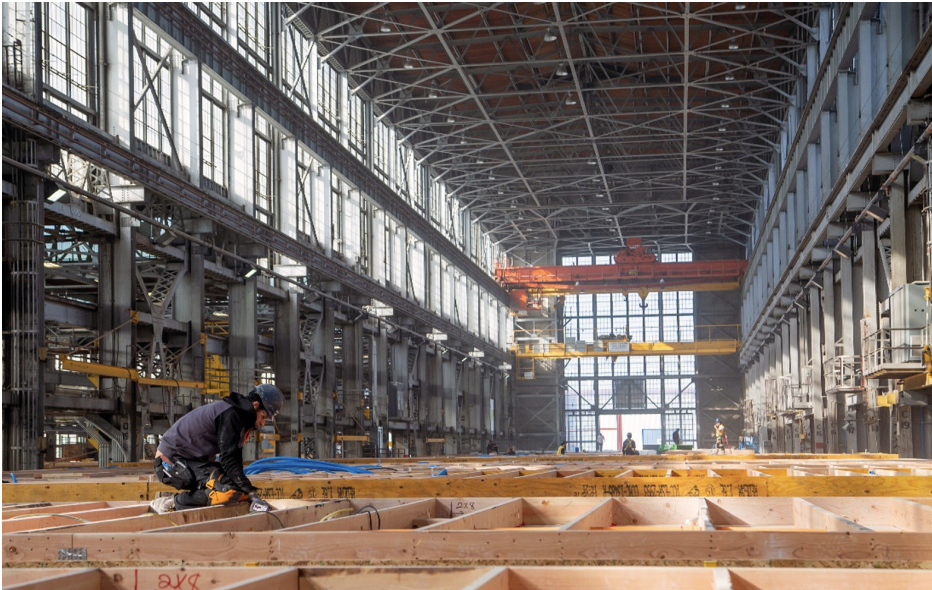

Overview of modules moving through the assembly line. Image courtesy of Autodesk.

Exhibit 2

Factory_OS Assembly Line

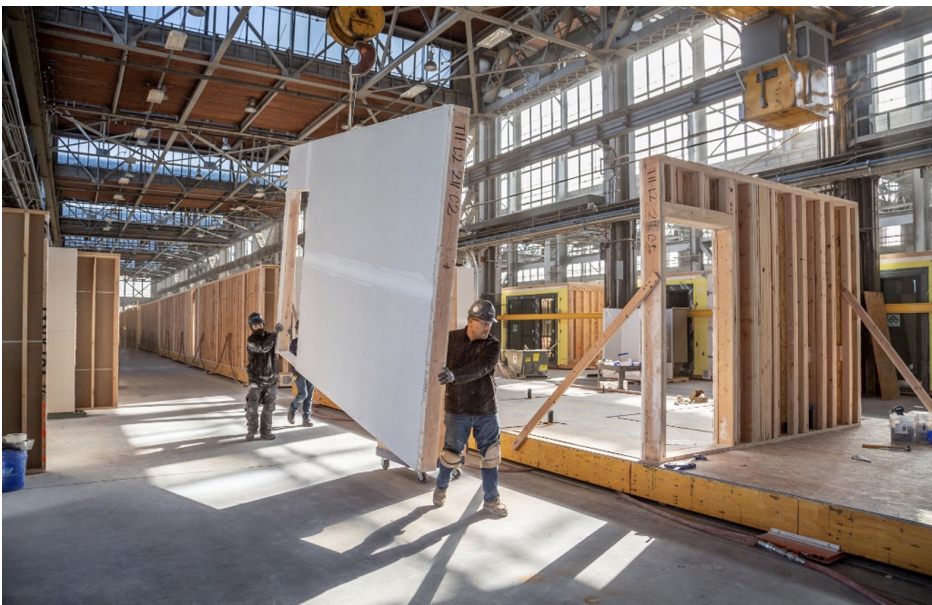

Wall assembly on the factory floor using gantry cranes. Image courtesy of Autodesk.

Exhibit 3

Factory_OS Onsite Module Installation



Hallway photo showing site-built connections planned for corridors. Image courtesy of Factory_OS.

Exhibit 4

Interior of Module at Factory_OS



Modules can be shipped with full interiors, including interior finishes and appliances. Image courtesy of Factory_OS.

Exhibit 5

Factory_OS Module Onsite Placement



Setting factory-built modules on site-built concrete podium. Image courtesy of Factory_OS.

Exhibit 6

Factory_OS Module Onsite Placement



Modular construction in progress on site. Image courtesy of Factory_OS.

Exhibit 7

Two-Bed Apartment Consisting of Two Factory-Built Modules

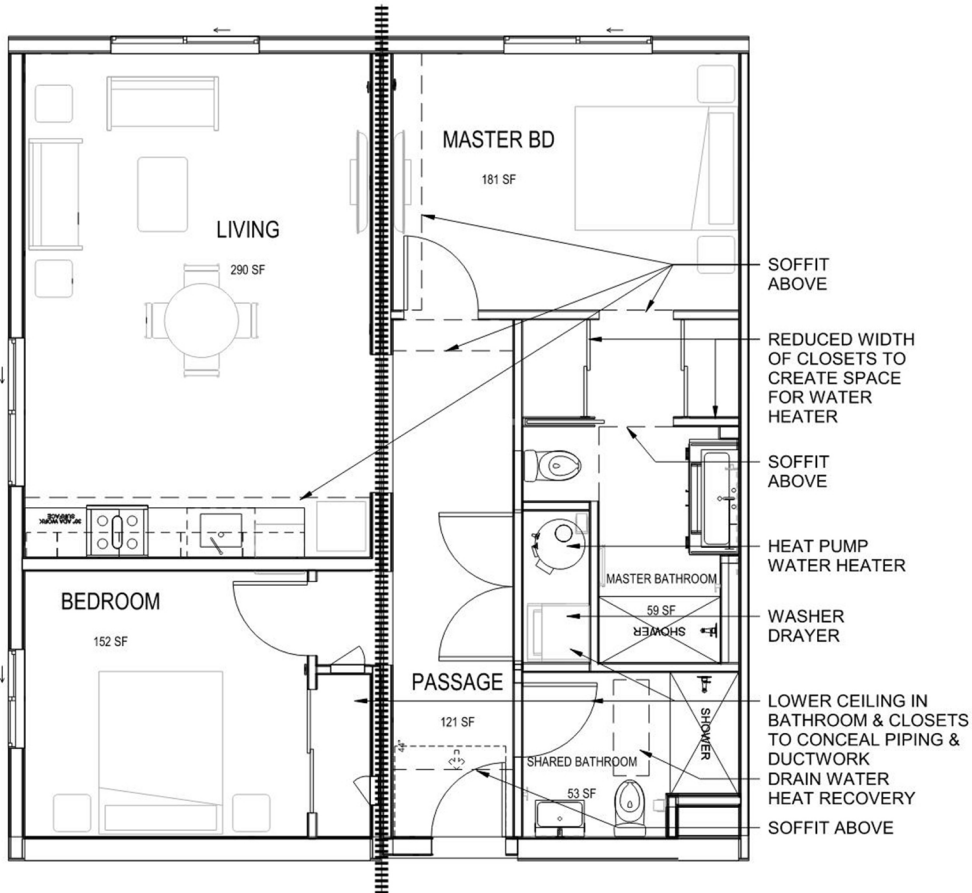

*Note: Example of two-bedroom unit using two modules, with module mate line dashed at the center.
Source: Factory_OS*

The major motivation for pursuing modular techniques is often the promise of time and cost savings, along with better building quality (Bertram et al., 2019; Pullen, 2022). Time savings largely result from the parallel onsite and offsite work streams; for example, onsite crews can begin excavation and foundation work while in-factory crews assemble apartment units—two work streams that would otherwise need to happen in sequence. Cost savings may occur as a direct result of the time savings and from increases in labor productivity and material efficiency through optimized factory production (Pullen, 2022). Better quality control practices using manufacturing principles and practices may also improve building quality and ultimate project performance (Pless et al., 2022). Finally, factory production can simplify construction processes to be more accessible and ergonomic, lowering the barrier to entry for unskilled workers and increasing diversity in the workforce (Pullen, 2022).

In proven performance toward those potential benefits, a growing body of evidence suggests that offsite construction offers total time savings in the range of 10 to 40 percent and cost savings in the range of 5 to 25 percent compared with traditional onsite construction (Decker, 2021; Pullen, 2022; Smith and Rice, 2015). However, recent research from the Turner Center found that housing industry stakeholders in California only see the *time* savings to be relatively consistent across projects, while cost savings are less predictable and more difficult to measure precisely (Pullen, 2022). Other benefits, including as-built quality and workforce development benefits, show the promising but inconclusive potential that will likely improve as industry familiarity and adoption increase (Pullen, 2022; Smith and Rice, 2015). Nonetheless, interest and investment in offsite and industrialized construction practices continue to grow across the United States, particularly in areas with high housing demand and skilled labor costs (Bertram et al., 2019; Pullen, Hall, and Lessing, 2019).

Exhibit 8

2121 Wood Street First-Level Mechanical Room

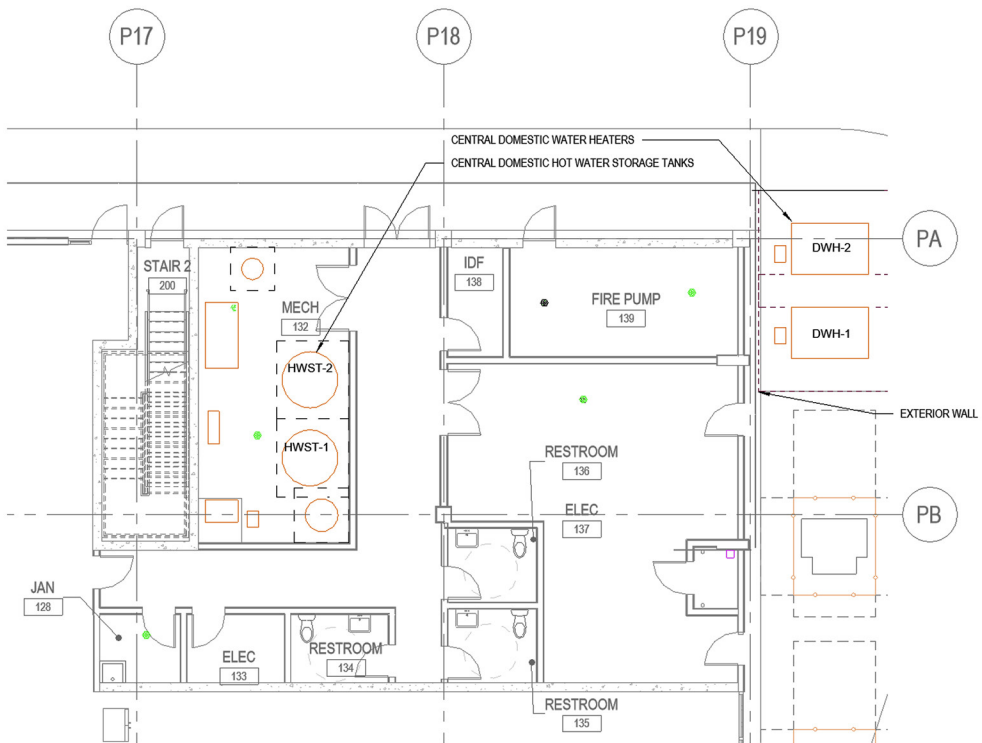

DWH = domestic water heater. HWST = hot water storage tank.

Notes: Centralized heat pump water heating system indicated as DWH-1 and DWH-2 (outside building) and HWST-1 and HWST-2 (inside mechanical room). Distribution piping is hidden for clarity. PA, PB, P17, etc. are architectural notation to distinguish building sections.

Source: Factory_OS

Domestic Hot Water Heat Pump Water Heaters

Heat pump systems are commonly used in heating, ventilation, and air-conditioning (HVAC) systems as an all-electric option to heat or cool the air in residential and commercial buildings. However, this technology can also be applied to heating water and is a substitute for fossil fuel-based domestic water heating systems, such as natural gas-fired water heaters or less efficient electric resistance water heaters.

Centralized Domestic Hot Water Heat Pump Water Heaters

In conventional stick-built construction, domestic hot water HPWHs used in large commercial buildings are typically centralized in a mechanical room, which includes a large air-sourced heat pump and storage tank (exhibit 8). In addition, a centralized heat pump design requires a lot of field-installed supply and recirculation piping with associated insulation. The vast amount of domestic hot water piping leads to energy losses as hot water is pumped through the building and transfers heat to its surroundings. A centralized HPWH system used as the reference case for this research project is based on a modular construction project in Oakland, California. The design includes two air-sourced heat pumps that sit outside the building (example in exhibit 9), extract heat from outdoor air, and send it to hot water storage tanks inside the mechanical room. Domestic hot water is then distributed throughout the building from the storage tanks. Although the individual apartment modules are constructed off site, the central water heating system requires field installation and connections to each apartment, which increases construction coordination complexity and field construction time.

Exhibit 9

Typical Example of Central Domestic Hot Water System (Before Insulation of Piping)



Large installations on roof are most common. Used with permission of Colmac WaterHeat.

Distributed Domestic Hot Water Heat Pump Water Heaters

This system leverages the advantages of prefabricated modular construction by allowing full installation of HPWH and domestic hot water (DHW) piping in the factory, with reduced onsite connections required (for example, for potable water, sanitary waste, and vent connection). Prefabrication requires an all-in-one heat pump (that is, storage tank plus heat pump) rather than the split (tank separate from heat pump) centralized unit used in the reference case. For this study, the all-in-one heat pump (with an example diagram in exhibit 10) is located inside an enlarged closet in the prefabricated apartment modules and extracts heat from inside the occupied space.

Exhibit 10

Representative All-in-One Heat Pump

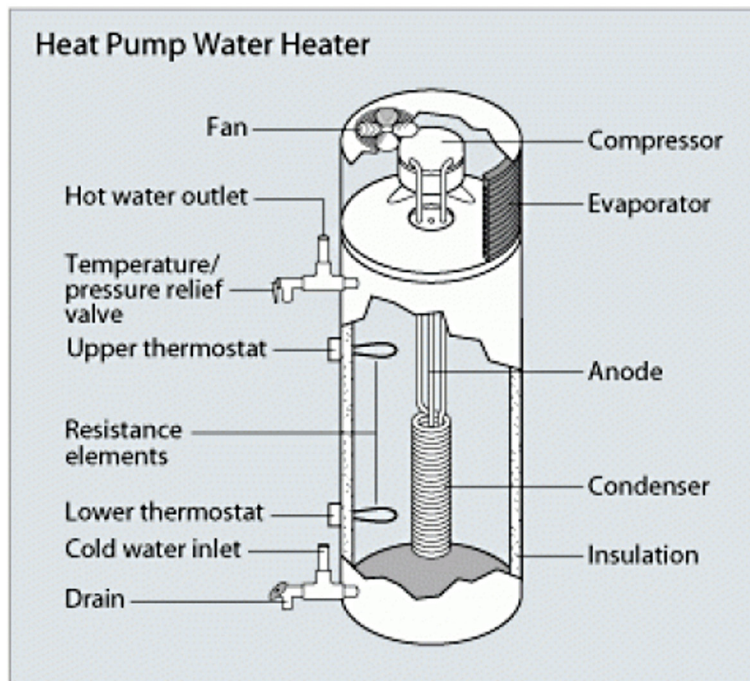

Note: Compressor, evaporator, condenser, and water storage all provided as single unit.
Source: U.S. DOE

The research team studied off-the-shelf, readily available HPWHs on the market for feasibility. A recent development in the distributed HPWH market is the shared circuit unit, which was used as the basis of design for this research. The shared circuit unit has a smaller electrical load than other products (which frequently offer hybrid operation with a less efficient electrical resistance backup mode) and is designed to plug into a standard 120-volt, single-phase outlet, sharing a 15-amp circuit with other electrical loads. This product targets the retrofit market to simplify natural gas water heater replacement without requiring upgraded electrical service, but the all-in-one installation also aligns well with modular housing methods.

A Note on Distributed HPWH Tank Sizing

Although the hot water demand profile varies between a studio, one-bedroom, two-bedroom, and three-bedroom apartment, cost advantages to scale exist in real-life projects. Instead of varying the heat pump tank size for each apartment type, the team designed each apartment with the same 50-gallon model. In addition to being sufficient to meet peak hot water demand and recovery rates for all apartment sizes and occupancies on the reference project, using a standard model size for the entire project provides additional cost savings and ease of coordination within the factory. However, tank sizing should be decided on a project-by-project basis.

Drain Water Heat Recovery

DWHR devices exchange heat between warm shower drain water and incoming domestic cold water. As shown in exhibit 11, flow streams do not directly mix: heat is conducted through a metal heat exchanger. The device recovers some of the energy spent heating the shower water after going down the drain to raise the temperature of incoming water without additional electricity use.

Exhibit 11

Horizontal Drain Water Heat Recovery

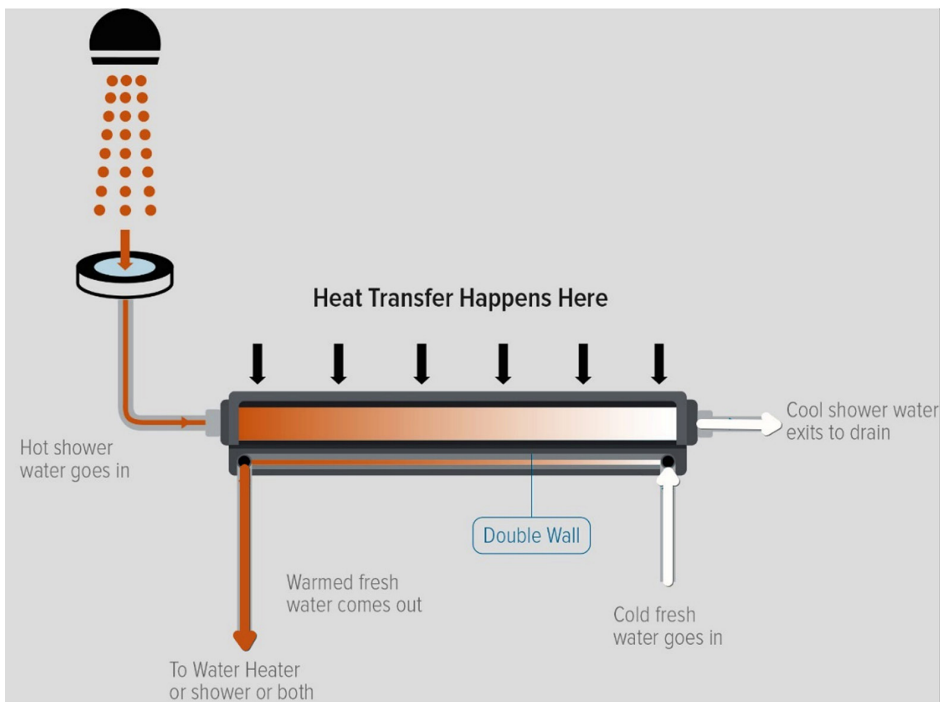

Source: Ecodrain

Minor design adjustments included using a horizontal DWHR (rather than a vertical one), which improves in-factory assembly and reduces distribution heat loss due to proximity to the water heater and shower fixture, but it also slightly increases the risk of clogging (exhibit 12).

Exhibit 12

Diagrams of HPWH and DWHR used in Research Model

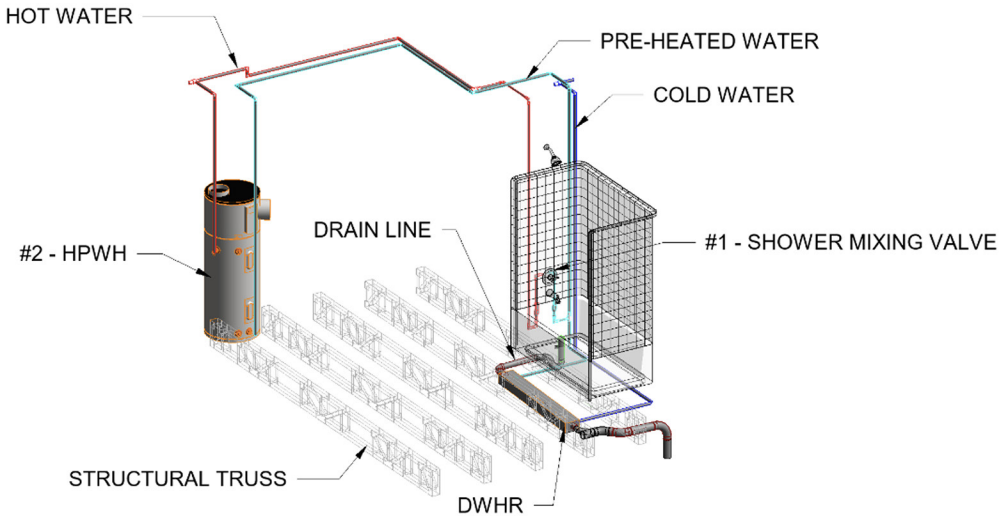

DWHR = drain water heat recovery unit. HPWH = heat pump water heater.

Notes: The horizontal drain water heat recovery device pre-heats incoming cold water that is then sent to the shower mixing valve (#1) and heat pump water heater (#2). DWHR coordination from Revit model showing slim profile of heat exchanger allows it to fit between structural framing, with other building elements hidden for clarity.

Overview of Reference Project Used for Analysis

To provide applicable and representative cost and energy use comparison, the research for this project focused on a comparison to a prefabricated 235-unit multifamily building under construction in Oakland, California, for which SmithGroup provided the full engineering design for the mechanical, plumbing, and electrical systems (exhibit 13). This project, 2121 Wood Street, included a centralized HPWH system that directly informed model assumptions and acted as a real-life reference point for energy use and construction cost comparison.

The layouts used as the “base case” for the studio, one-bedroom, and two-bedroom units were designed for the Wood Street project. Each unit type originally included a washer/dryer closet that was enlarged to accommodate the in-unit HPWH for the distributed system. Additional adjustments were made to the layout to accommodate accessibility standards frequently attached to affordable housing funds—a consideration independently recommended by several industry professionals with experience in modular construction and affordable housing projects. In the following sections, the authors use the studio unit to illustrate the changes made for the distributed water heating system (exhibit 14). Similar changes have also been documented for the one- and two-bedroom units in the base case, and a three-bedroom unit was designed with similar intent (although it did not exist in the base case).

Exhibit 13

Reference Project, 2121 Wood Street Architectural Rendering



Source: MBH Architects

Exhibit 14

Architectural Floor Plans of Studio Unit



DWHR = drain water heat recovery, HPWH = heat pump water heater.
Note: Architectural floor plans of studio unit comparing base case (left) to revised design with heat pump water heater and drain water heat recovery (right).

The HVAC system was also modified to accommodate the HPWH, which requires two ductwork connections, a source-air inlet, and a discharge air outlet. To minimize the duct runs and to keep the plumbing design compact, the team elected to have the HPWHs use the room air as the source air. The cool air is ducted to mix with neutral temperature air from the central ventilation system to lower the impact of cool discharge air dumped directly from the HPWH into occupied space. Additional design adjustments mitigated the risk of nuisance sound from the HPWH compressor and fan operation. Exhibit 15 highlights the HVAC system layout, and exhibit 16 diagrams the warm air inlet and cool air outlet.

Exhibit 15

HVAC Floor Plans

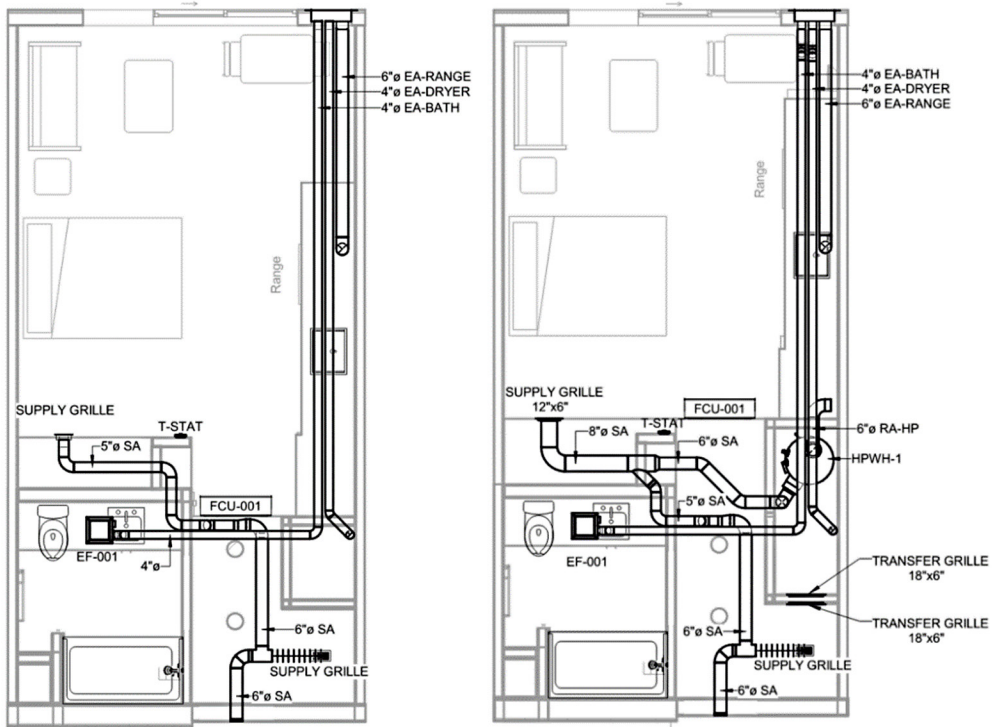

EA = exhaust air. EF = exhaust fan. FCU=fan coil unit. HPWH = heat pump water heater. RA = return air. SA = supply air. T-stat = thermostat.

Notes: HVAC floor plans highlighting changes between reference building, shown on the left, and modified building, shown on the right. Recirculation hoods are not allowed in California, so the kitchen hood ("range" on plan) is exhausted directly outdoors.

Exhibit 16

Warm Air Inlet and Cool Air Outlet

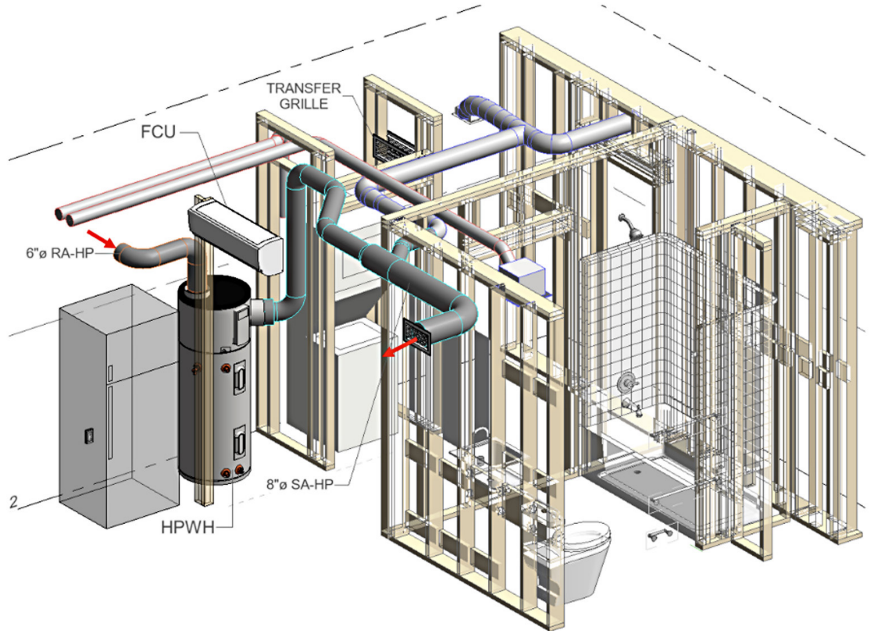

*FCU = fan coil unit. HPWH = heat pump water heater. RA-HP = return air to heat pump. SA-HP = supply air from heat pump. Transfer Grille = opening to transfer air into closet.
Note: View showing warm air inlet (arrow in background) and cool air outlet of HPWH (arrow in foreground).*

Mechanical piping and plumbing-related modifications were the most extensive changes. Specifically, the entire centralized domestic water heating distribution system was removed. For reference, 2121 Wood Street is a six-story building with approximately 5,000 linear feet of domestic hot water recirculation piping. Exhibits 17 highlights the extensive piping for the central domestic water heating system that can be removed with the distributed system, and exhibit 18 shows the in-unit piping that replaces it.

Exhibit 17

Plumbing Plan

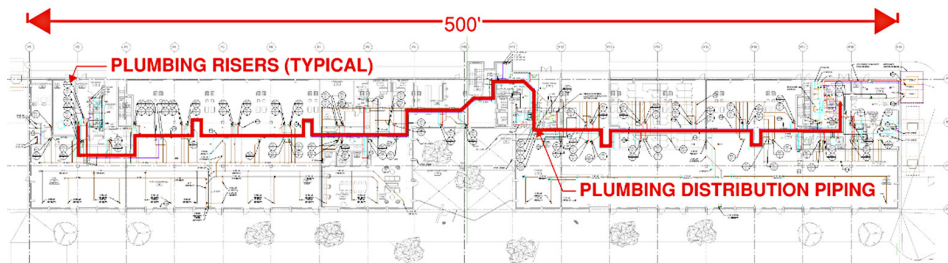

DHW = domestic hot water.

Notes: Ground level plumbing plan highlighting the domestic water heating distribution and recirculation piping that serves vertical risers through each apartment unit. This scope was removed in the modified building with distributed heat pump water heaters.

Exhibit 18

Plumbing and Mechanical Piping Plans

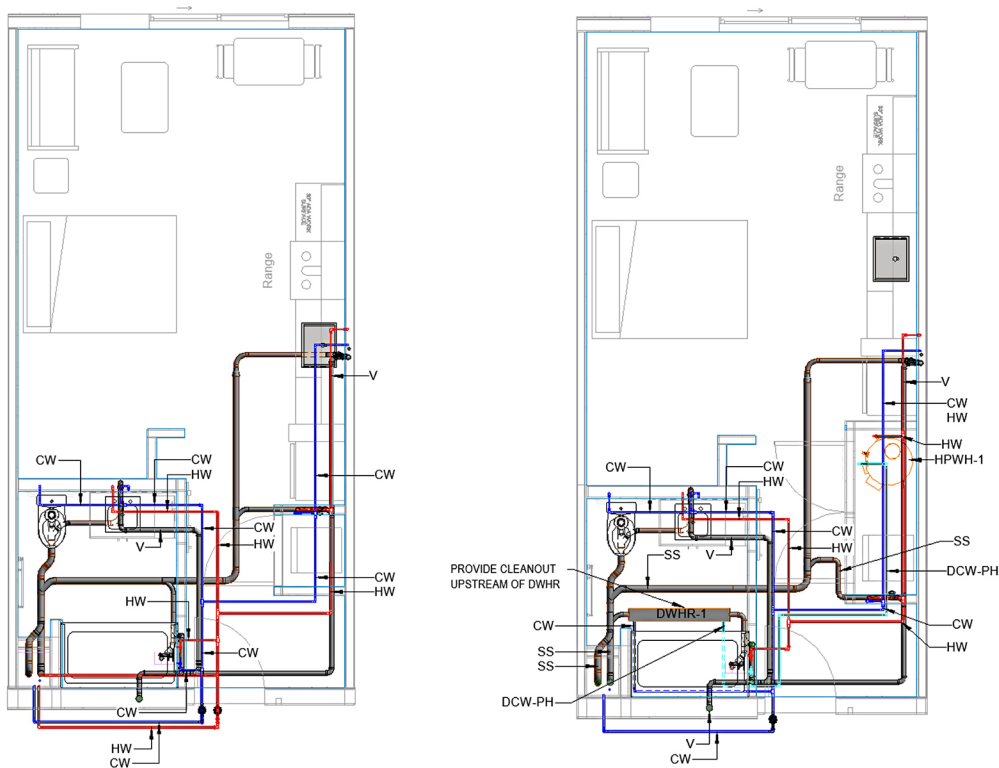

CW = cold water. DCW-PH = pre-heated domestic cold water. DWHR = drain water heat recovery. HW = hot water. V = vent. HPWH = heat pump water heater. SS = sanitary.

Notes: Plumbing and mechanical piping plans show the reference case on the left and the modified plan on the right. The hot water piping in the corridor from the centralized system (bottom of reference case plan) has been removed in the modified plan. Also, the modified plan shows the addition of the pre-heated domestic cold-water piping from the DWHR device.

Findings

Energy Analysis Findings

The annual simulation results of the whole building energy model from the reference case 2121 Wood Street building demonstrate that a distributed heat pump domestic water heating system uses less energy annually than a centralized heat pump water heating system in Oakland, California (exhibit 19). Both heat pump water heating options, centralized and distributed, outperform a traditional gas-fired central water heater-based domestic hot water system. The distributed HPWH design, which included free cooling and drain water heat recovery, further reduced energy use. Compared with centralized HPWHs, most of the energy savings for the distributed HPWHs came from removing the hot water distribution recirculation system. Even when insulated to current code requirements, a centralized DHW distribution network results in significant heat loss from the hot water to the interior of the building because the circulating hot water acts as a radiator along the full piping system (on the interior of the building). A centralized HPWH resulted in 29-percent annual energy savings over the gas-fired domestic water heating system. The distributed HPWHs, accounting for impacts to heating and cooling loads (for example, free cooling) during DHW generation, resulted in 3-percent total energy savings compared with a central HPWH. The DWHR system provided an additional 2- to 2.5-percent savings. If all measures were combined, the distributed HPWHs with the free cooling and DWHR produced 31-percent savings—and up to 35-percent savings in cool climates—compared with the centralized gas-fired water heating system. For this analysis, the cool climate was assumed to be Rochester, Minnesota.

Exhibit 19

Baseline Versus Proposed Water Heater Systems

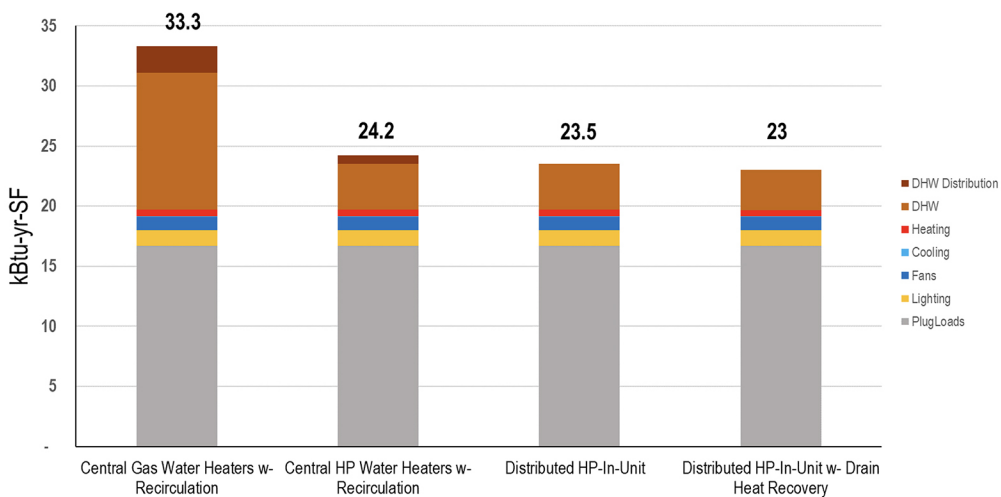

DHW = domestic hot water. HP = heat pump. kBtu-yr-SF = kilo-British thermal units per year per square foot, a measure of energy use normalized for time and building size.

Note: Example energy modeling results from a project located in Oakland, California.

The team expanded the energy modeling analysis to explore if the results found in Oakland, California, would be replicated in other climate zones. The primary impact in different climate zones is whether the “free cooling” produced by cool discharge air from the distributed HPWHs is beneficial or harmful to annual energy use. This relationship is quite complex to model, as it requires an understanding of hourly cooling and heating demands and the behavioral impacts of when an occupant uses domestic hot water. The research team altered DHW fixture draw profiles to represent a realistic day-to-day operation in reference to the research paper from Big Ladder Software (Kruis et al., 2017). Using the above draw profiles, the team was able to perform parametric runs in each climate zone to understand the impacts of the free cooling and the impacts from storage tank heat losses into the space.

The results are somewhat intuitive. In hot, warm, and mild climates, the free cooling provides a benefit to total annual energy use. However, in mixed, cold, and very cold climates, the free cooling is detrimental to overall annual energy use, as the distributed HPWH effectively steals heat from the interior space which must be made up by the space heating system. Exhibit 20 shows the total annual energy impact of the free cooling for a typical one-bedroom unit. The percentage of total energy offset with free cooling is the percentage difference in annual energy with HPWH being inside the unit (free cooling included) versus being located outdoors (free cooling excluded).

Exhibit 20

Impact of Free Cooling from Heat Pump Water Heater on Annual Energy Use

ASHRAE Climate Zone	Climate Condition	Representative City	% Total Energy Offset with Free Cooling
0A	Extremely Hot Humid	Ho Chi Minh City	-0.05%
0B	Extremely Hot Dry	Abu Dhabi	0.12%
1A	Very Hot Humid	Honolulu	0.13%
1B	Very Hot Dry	New Delhi	0.03%
2A	Hot Humid	Tampa	-0.02%
2B	Hot Dry	Tucson	0.06%
3A	Warm Humid	Atlanta	-0.20%
3B	Warm Dry	El Paso	-0.05%
3C	Warm Marine	San Diego	0.04%
4A	Mixed Humid	New York City	-0.44%
4B	Mixed Dry	Albuquerque	-0.37%
4C	Mixed Marine	Seattle	-0.07%
5A	Cool Humid	Buffalo	-1.23%
5B	Cool Dry	Denver	-1.14%
5C	Cool Marine	Port Angeles	-0.11%
6A	Cool Humid	Rochester	-1.88%
6B	Cool Dry	Great Falls	-1.42%
7	Very Cold	International Falls	-2.35%
8	Subarctic/Arctic	Fairbanks	-2.80%

ASHRAE = American Society of Heating, Refrigerating, and Air-Conditioning Engineers.

Note: Positive percentages reflect beneficial free cooling from heat pump water heater, whereas negative percentages indicate that cool air from heat pump water heater increases energy use.

The distributed HPWH outperforms a centralized HPWH system regardless of the climate zone. Even in the extremely cold climate zone 8, locating the heat pump within the unit results in less than a 3-percent penalty on annual energy use. In all climate zones in which distributed HPWHs had detrimental impacts on annual energy use, it was still less in magnitude than the increase in energy associated with a centralized system's recirculation loop.

Construction Cost Findings

In modular construction, having an in-unit HPWH will necessarily increase the material and labor cost of the individual prefabricated module compared with a centralized system with only a whole-building HPWH system and no in-unit DWHR (as with the reference project). The cost premium of the distributed system relative to the centralized system reflects an estimate from Factory_OS in the summer of 2022, noted because of product pricing fluctuations due to continued supply chain variability and uncertain impacts of ongoing inflation. The net cost-per-unit premium was calculated by determining each module's cost increase associated with the distributed system relative to the module's base scope with a centralized system, then subtracting the per unit site-built deduction cost. The per unit site built deduction was calculated by dividing the cost of the centralized system's site-built scope by the total number of units in the 2121 Wood Street building. The site-built scope deduction included the plumbing and electrical scope associated with the centralized domestic water heating system, including large central heat pump water heaters, storage tanks, distribution piping, and the recirculation pump. The site-built deduction is based on Oakland, California, labor rates as of 2022 and will vary greatly on the basis of region and year. In the distributed system, domestic cold water piping to the apartments will need to accommodate the additional makeup water flow to the individual HPWHs. However, the flow increase was insufficient to increase the domestic cold water piping size and thus was not considered a cost addition.

The research team compared the electrical system impact of centralized and distributed domestic water heating systems using the reference project for cost differences. The building at 2121 Wood Street has two centralized heat pumps, and each heat pump has a larger compressor and electrical load than an individual distributed HPWH. If applying a shared circuit HPWH distributed system, approximately 235 HPWHs would be distributed across the building's apartment units. The HPWHs would be on a general-purpose receptacle circuit; the kitchen equipment has dedicated circuits. The latter approach offers increased electrical load diversity and resulted in approximately 130 amps less in site electrical load when compared with the centralized system. In the case of 2121 Wood Street, this electrical load reduction was not enough to reduce service size (for example, the size or quantity of required transformers or both); however, having a potential reduction—or at least being electrical load neutral—is a benefit of the distributed approach and could allow for service reductions on projects with a different electrical load profile. Exhibit 21 reflects the final result of the estimated cost comparison across system types.

Exhibit 21

Distributed System Cost Premium After Site Work Deductions

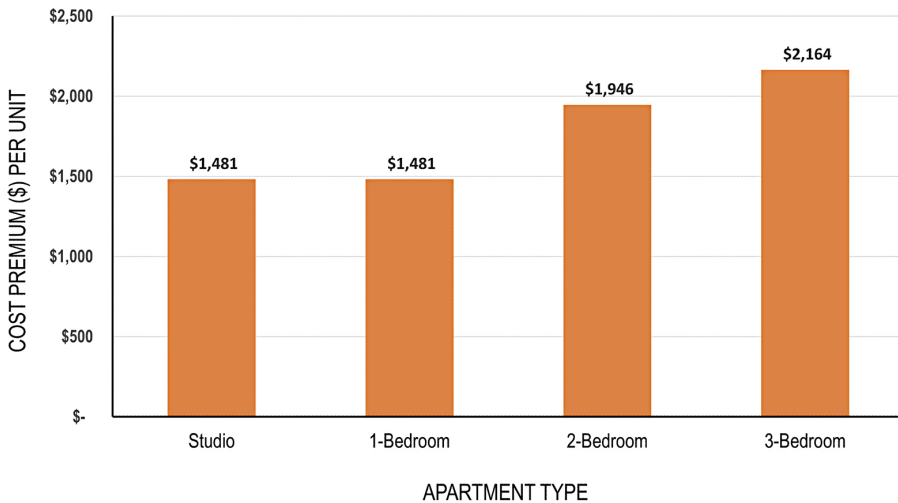

Note: Graph shows cost premium broken out by apartment unit type.

After factoring in the site-built scope deduction, the cost premium of the distributed system varied from approximately \$1,500 to \$2,200, increasing with the number of bedrooms. For 2121 Wood Street, that would result in approximately \$370,000 premium to the project, an approximate 0.5 percent increase in total project cost. These costs do not factor in potential rebate and incentive programs that may be available, given the passage of the Inflation Reduction Act, or through other state and local programs, which could ultimately reduce the cost premium of the distributed system.

Whereas the research team found a material and labor cost premium to the distributed system, prefabricated modules with distributed HPWH systems offer potential time savings to the project by reducing onsite construction scope. However, this factor is difficult to precisely measure due to multiple overlapping onsite trades and subcontractors involved with centralized system installations and, thus, is outside the scope of these estimates.

Factory-built housing may also provide potential quality control improvements that are of particular interest for distributed HPWH systems: the research team's industry interview feedback and the team's experience are that installation problems can frequently undermine the performance (and promised energy savings) of those systems. Modular construction techniques, however, can incorporate an optimal design and installation procedure for HPWHs within each enclosed module, ensuring consistent and reliable installation and inspection practices. Doing so can also integrate in-unit space and water heating capabilities in a standardized set of apartment units offered on multiple projects, which could dramatically reduce the upfront design scope compared with centralized heating systems for multifamily housing projects (which must be designed project to project).

Conclusion

The research findings are promising. Both centralized and distributed HPWH can dramatically reduce domestic water heating and overall building energy use compared with natural gas systems. Although the distributed HPWH system has a per-unit cost premium, modular construction approaches provide benefits to project schedule and installation quality that are not yet captured in this preliminary research. However, integrating distributed HPWH systems into modular building methods is not without unique challenges and opportunities to consider when translating research toward industry adoption:

Building codes: Prescriptive building codes across the United States may not be amenable to innovation in the built environment, including offsite construction processes and HPWH systems. Building codes are often written with onsite construction in mind (Colker et al., 2022), and even minor improvements such as the horizontal DWHR device may require amendments or exceptions to existing local codes. Such adjustments for specific products or technologies can be made, but increased adoption of performance-based codes could more broadly improve the viability and application of innovative, cost-saving, and energy-efficient technologies.

Permitting and inspection processes: Around the country, administratively complicated, unpredictable, and inconsistent permitting and inspection processes can challenge any procedural or technological innovation in construction, including offsite methods. Efforts to streamline and improve the consistency of local permitting procedures allow effective solutions to grow and provide their maximum potential benefit toward affordability and sustainability goals. This statement is especially true for strategies, such as modular construction, that depend on consistent outputs for factory-produced units. Procedural improvements to permitting could include the following:

- Single-agency review, in which developers submit plans through only one local government agency rather than separate submissions and sequential review by planning, fire, building, and public works departments.
- Limits on discretionary review (which can be time-consuming and assess projects based on subjective review standards), such as the adoption of objective review standards in the zoning code.
- Regional or state government interventions that limit local jurisdictions' ability to limit new housing construction, particularly jurisdictions failing to meet housing production needs. Massachusetts 40B, a state law passed in 1969, does exactly this, and Turner Center researchers found several tangible benefits that include lowering the cost of affordable housing construction and making housing delivery more efficient (Reid, Galante, and Weinstein-Carnes, 2016).

Sustainability-focused policies: New and existing tax credits to encourage advanced energy efficiency could cover all or part of the upfront installation cost of distributed domestic hot water heating systems. Early analyses of the Inflation Reduction Act found more than \$50 billion dedicated to building electrification and energy efficiency in buildings, primarily through tax credits and rebate programs, for which new multifamily housing construction should be eligible

(Jenkins et al., 2022). Products such as HPWHs (distributed and otherwise) should be eligible for many of these programs, but limited eligibility and administrative constraints may present new challenges. Those challenges may be especially true for aligning incentives with builders and owners of rental properties, many of whom do not see the bulk of the cost savings from upfront investments in energy efficiency. To support the uptake of progressive energy efficiency funding, existing subsidies for affordable housing at multiple levels of government could also add scoring criteria to encourage and reward highly energy- and cost-efficient designs and construction methods. Such scoring systems would tangibly incentivize the adoption of cost-effective, high-quality new construction and send an important signal to researchers and practitioners that could improve and proliferate processes and products to accelerate the trend further.

Learning curves: Professionals across the diverse housing industry—from architects to general contractors to skilled laborers and beyond—will require exposure to and training for any new technology or process in housing construction. These barriers require coordinated engagement across historically fragmented stakeholder networks (including multi-scalar government agencies). Early efforts to accelerate the adoption of technologies such as these include the Advanced Building Construction Collaborative, a DOE-funded initiative to connect and grow viable solutions to many of the challenges facing the built environment industry. The team’s broader research initiative will elaborate on potential barriers and opportunities for policy and industry interventions to unlock and encourage the proposed gains from the dual innovations analyzed. The research team will continue to work with industry trade associations, other academic institutions, the press, and government agencies at multiple levels to ensure wide dissemination and amplification of this work. The goal is to remove obstacles to make standard practice out of quality design and construction at affordable costs.

Glossary

centralized water heating system—system for heating water, driven by a large, centralized unit that stores and distributes water, with interconnected piping throughout the entire building. Typically, the water heaters and storage are located on the ground level and can be electric or gas fired.

distributed or decentralized water heating system—system that includes a series of independently operating water storage and heating units in each housing unit in an apartment building, typically located inside a closet.

drain water heat recovery (DWHR)—system that recovers heat from warm shower water going down the drain to preheat cold, incoming water before entering the water heater, saving energy.

electric heat pump—equipment that sources ambient heat from indoor or outdoor air to warm or cool a space, using electricity rather than onsite fossil fuels. Heat pump performance is directly proportional to its coefficient of performance, a metric representing the ratio of useful work output (for example, heating) to input energy required. Typically, heat pumps have coefficients of performance higher than 1, meaning that they produce more energy in heat than they use in electricity.

factory-built or modular housing—housing in which each apartment unit is built to substantive completion in an offsite manufacturing facility, including structural (floors, walls, and ceilings), mechanical, electrical, and plumbing systems. Elements are assembled in the factory to produce the modular “boxes” that are then transported to a project site, with potential savings in project time and cost.

free cooling—the ability of a heat pump water heater to cool the air around it during operation. Free cooling is a result of the heat pump operation that takes warm source air from the room and uses it to generate domestic hot water. The source air then discharges from the heat pump and returns to the room as cool air. This cooling effect is considered free cooling because it is a byproduct of the heat pump water heater’s primary goal, which is to generate hot water.

heat pump water heater (HPWH)—equipment option for generating hot water in centralized or distributed systems using electric heat pumps. Typically, these devices source ambient heat from outdoor or indoor air. Heat pump water heaters are not typically considered part of the full-building space heating or cooling system, but they provide free cooling during operation to the individual unit in which they are installed.

shared circuit heat pump water heater—120-volt single-phase distributed heat pump water heater with low current draw that does not require a dedicated electrical circuit. In other words, it can plug into a standard U.S. electrical outlet on a 15 A circuit and share that circuit with other electrical loads in a residential setting.

site-built construction—conventional style of construction, in which raw materials are ordered and shipped separately to be assembled and erected primarily on site.

Acknowledgments

The authors gratefully acknowledge the financial support provided by HUD for this research under grant number H-21687 CA. Further, the authors thank Mike Blanford and Luis Borray for managing this project on HUD’s behalf and Blaythe Ayala and Katina L. Jordan for their additional help in coordinating the work. Several industry experts in energy-efficient design, environmental policy, and offsite construction (who prefer to remain anonymous) also provided key insight that guided the team and the work. Finally, the authors thank the editors and two referees for their helpful suggestions.

Authors

Victor Braciszewski is a mechanical engineer for SmithGroup based in San Francisco. He has expertise in building performance analysis, focusing on HVAC system design and modeling. Stet Sanborn is a principal and engineering discipline leader in SmithGroup’s San Francisco office. His work in and outside professional practice centers on building decarbonization and electrification. Justin Tholen is an architectural project manager in SmithGroup’s San Francisco office, with

experience managing projects and research throughout all phases of predevelopment and construction. Harshana Thimmanna works out of SmithGroup's San Francisco office as a senior building performance analyst, conducting energy modeling and simulations for HVAC system design and construction. Tyler Pullen is a doctoral student in the Department of City and Regional Planning at UC Berkeley and a graduate student researcher for the Turner Center for Housing Innovation. Tyler has extensive experience researching innovative and industrialized construction, with an emphasis on its intersection with housing market and policy dynamics, particularly in California. Carol Galante is the founder of and advisor for the Turner Center for Housing Innovation at UC Berkeley and The Housing Lab (<https://www.housinglab.co/housing-lab>), an accelerator program working with early-stage ventures on housing affordability. She is the emeritus faculty director of the Turner Center and held the I. Donald Turner Professorship in Affordable Housing and Urban Policy at UC Berkeley from 2015 through 2021. She previously served in the Obama Administration in the U.S. Department of Housing and Urban Development. Before her appointment at HUD, she served for more than 10 years as president and CEO of BRIDGE Housing Corporation. Jamie Hiteshew is the vice president of development at Factory_OS, leading Factory_OS's housing development efforts and helping to manage the factory's project and research pipeline.

References

- Bertram, Nick, Steffen Fuchs, Jan Mischke, Robert Palter, Gernot Strube, and Jonathan Woetzel. 2019. *Modular Construction: From Projects to Products*. McKinsey & Company. <https://www.mckinsey.com/capabilities/operations/our-insights/modular-construction-from-projects-to-products>.
- Colker, Ryan, Diana Fisler, Lucas Toffoli, Alyssa Watson, Ian Blanding, Martha Campbell, Ankur Dobriyal, et al. 2022. *New Off-Site Construction Standards: Potential & Implications of ICC/MBI 1200 and 1205 for Advanced Building Construction*. Advanced Building Construction Collaborative.
- Decker, Nathaniel. 2021. *Strategies to Lower Cost and Speed Housing Production: A Case Study of San Francisco's 833 Bryant Street Project*. Turner Center for Housing Innovation. <https://turnercenter.berkeley.edu/research-and-policy/833-bryant-street-sf/>.
- Jenkins, Jesse D., Erin N. Mayfield, Jamil Farbes, Ryan Jones, Neha Patankar, Qingyu Xu, and Greg Schivley. 2022. *Preliminary Report: The Climate and Energy Impacts of the Inflation Reduction Act of 2022*. Princeton, NJ: REPEAT Project.
- Kingsella, Mike, and Leah MacArthur, eds. 2022. *2022 Housing Underproduction™ in the U.S.* Washington, DC: Up for Growth. <https://upforgrowth.org/apply-the-vision/housing-underproduction/>.
- Klammer, Noah, Zoe Kaufman, Ankur Podder, Shanti Pless, David Celano, and Stacey Rothgeb. 2021. *Decarbonization During Predevelopment of Modular Building Solutions*. Golden, CO: National Renewable Energy Laboratory. <https://www.osti.gov/biblio/1837021>.

Kruis, Neal, Bruce Wilcox, Jim Lutz, and Chip Barnaby. 2017. *Development of Realistic Water Draw Profiles for California Residential Water Heating Energy Estimation*. San Francisco, CA: International Building Performance Simulation Association. http://www.ibpsa.org/proceedings/BS2017/BS2017_237.pdf.

Manley, Karen, and Kristian Widén. 2019. "Prefabricated Housing Firms in Japan and Sweden: Learning from Leading Countries." In *Offsite Production and Manufacturing for Innovative Construction*, edited by Jack S. Goulding and Farzad Pour Rahimian. London: Routledge. <https://www.taylorfrancis.com/chapters/edit/10.1201/9781315147321-17/prefabricated-housing-firms-japan-sweden-karen-manley-kristian-wid%C3%A9n>.

Pless, Shanti, Ankur Podder, Zoe Kaufman, Noah Klammer, Conor Dennehy, Naveen Kumar Muthumanickam, Stacey Rothgeb, Joseph Louis, Colby Swanson, Heather Wallace, and Cedar Blazek. 2022. *The Energy in Modular (EMOD) Buildings Method: A Guide to Energy-Efficient Design for Industrialized Construction of Modular Buildings*. Golden, CO: National Renewable Energy Laboratory. <https://doi.org/10.2172/1875070>.

Podder, Ankur, Shanti Pless, Stacey Rothgeb, Noah Klammer, Cedar Blazek, Joseph Louis, and Khandakar Mamunur Rashid. 2020. *Integrating Energy Efficiency Strategies with Industrialized Construction for Our Clean Energy Future*. Golden, CO: National Renewable Energy Laboratory. https://www.researchgate.net/publication/345753308_Integrating_Energy_Efficiency_Strategies_with_Industrialized_Construction_for_our_Clean_Energy_Future.

Pullen, Tyler. 2022. *Scaling Up Off-Site Construction in Southern California: Streamlining Production of Affordable and Supportive Housing*. UC Berkeley, Turner Center for Housing Innovation. <https://turnercenter.berkeley.edu/research-and-policy/off-site-construction-southern-california/>.

Pullen, Tyler, Daniel Hall, and Jerker Lessing. 2019. A Preliminary Overview of Emerging Trends for Industrialized Construction in the United States. White paper. <https://doi.org/10.3929/ethz-b-000331901>.

Raetz, Hayley, Teddy Forscher, Elizabeth Kneebone, and Carolina Reid. 2020. *The Hard Costs of Construction: Recent Trends in Labor and Materials Costs for Apartment Buildings in California*. UC Berkeley, Turner Center for Housing Innovation. <https://turnercenter.berkeley.edu/research-and-policy/hard-construction-costs-apartments-california/>.

Reid, Carolina. 2020. *The Costs of Affordable Housing Production: Insights from California's 9% Low-Income Housing Tax Credit Program*. UC Berkeley, Turner Center for Housing Innovation. <https://turnercenter.berkeley.edu/research-and-policy/development-costs-lihtc-9-percent-california/>.

Reid, Carolina K., Carol Galante, and Ashley F. Weinstein-Carnes. 2016. *Borrowing Innovation, Achieving Affordability: What We Can Learn from Massachusetts Chapter 40B*. UC Berkeley, Turner Center for Housing Innovation. <https://turnercenter.berkeley.edu/research-and-policy/california-40b/>.

Smith, Ryan E., and Talbot Rice. 2015. *Permanent Modular Construction: Process, Practice, Performance*. Modular Building Institute Foundations. <https://www.bdcuniversity.com/permanent-modular-construction-process-practice-performance>.

U.S. Energy Information Administration (EIA). 2015. *Residential Energy Consumption Survey*. Washington, DC: U.S. Energy Information Administration. <https://www.eia.gov/consumption/residential/>.

Woetzel, Jonathan, Sangeeth Ram, Jan Mischke, Nicklas Garemo, Shirish Sankhe. 2014. *A Blueprint for Addressing the Global Affordable Housing Challenge*. McKinsey Global Institute. <https://www.mckinsey.com/featured-insights/urbanization/tackling-the-worlds-affordable-housing-challenge>.

Factory Complete Heating and Cooling Solutions for Manufactured Homes

Emanuel Levy

Jordan Dentz

Yi-Jia Liao

Systems Building Research Alliance

Abstract

The manufactured housing industry could benefit from plant-installed, commercially competitive, and fully integrated heating and cooling solutions. This study explores two hardware integration and product configuration options that improve home performance and quality. It also explores changes to commercial arrangements, including the equipment distribution, inventory, and servicing necessary to align commercial interests. A production facility in southern Georgia integrated two system options into newly constructed manufactured homes: a packaged unitary system and a ducted mini-split heat pump. The findings demonstrate that both systems can be successfully implemented in the home production facility and operated as intended after transport. The packaged unitary system can be installed without additional work and skills. The ducted mini-split system requires more training and labor to install, but it costs less and has other benefits. By piloting these alternative heating and cooling systems, this study is a stepping stone for manufacturers looking for options to improve energy performance while reducing upfront cost.

Introduction

A defining characteristic of the manufactured housing industry is the consistency in construction method, design, and approach to sales among the 143 plants producing about 105,000 homes per year nationwide (MHI, 2022). Furthermore, many building and design practices that typify the industry have changed little in decades. One explanation for the lack of change is that the Manufactured Home Construction and Safety Standards (MHCSS), commonly referred to as the U.S. Department of Housing and Urban Development “HUD Code,” has changed little for many years and mandates energy standards less stringent than the state codes (Talbot, 2012). In some cases, these practices have stymied innovation and resulted in system inefficiencies. One of the most glaring examples of an antiquated practice that systemically degrades performance is installing the components of the heating and cooling system in two stages, with the home

manufacturer installing some parts, such as heating and some distribution components, in the factory and a technician installing other parts, such as cooling and parts of the distribution system, in the field (Dentz and Zhu, 2021). According to interviews with multiple industry experts, this bifurcation can result in reduced system operating efficiency, service issues, poor comfort, and increased homeownership costs. This article reports on a project that reimagines and reengineers the design and fabrication of the heating and cooling system, with all components installed in the plant under the existing regulated quality control regime.

The project concept evolved from discussions among industry experts asked to identify meaningful research that addresses the complex challenge of improving performance and affordability at the same time. The solutions and innovations are built on existing industry practices and promising technologies not currently used in the industry. The authors conducted a vetting process that required collaboration and partnerships with stakeholders, resulting in a list of “best” solutions. The project also builds on recent advances in heat pump technology that were not available previously.

The project aims to accomplish two core industry goals—making homes more affordable on a sustainable basis by lowering energy costs and improving quality. The work will drive down the cost of installing heat pumps, an important energy-efficient technology. Key aspects of the current heating and cooling selection, design, and installation process will likely change as project results are deployed. In the future, the manufacturer will take on most of the equipment installation responsibilities, such as installing the outdoor unit (whether air conditioning or heat pump) and refrigerant line connections, thereby revamping and replacing steps currently under the purview of the HVAC distributor and site technician.¹ Heating and cooling systems pre-installed in the manufactured home plant could also provide opportunities for quality assurance on duct leakage and airflow testing in homes before shipment, ensuring system quality and functionality. Plant-installed heating and cooling systems could also provide a more standardized set of operation instructions, helping to educate occupants on operations and maintenance needs and recognize the value of heat pumps.

Given the range of options, it is anticipated that regulators will accommodate technology changes in the short term through Alternate Construction letters. If the MHCSS, or HUD Code, restricts the use of a proposed heating and cooling system change, a process will be initiated to propose changes in the regulations through the normal Standards update process. To identify and address such issues preemptively, staff in the HUD Office of Manufactured Housing Standards will be kept abreast of project advances.

These research efforts, led by a team of engineers and marketing professionals and guided by a group of manufactured housing stakeholders, was based on applying an integrated and multidisciplinary approach to heating and cooling system design. The team sought to change deeply ingrained practices in the methods of home production, delivery, and installation. The recommendation included technical changes and new marketing, sales, and service approaches. HUD was the catalyst for bringing together otherwise competing industry members to cooperate to accomplish a common set of goals and to provide publicly available, independently verified results and data. The results provide the basis for improving home quality and energy efficiency.

¹ HVAC = heating, ventilation, and air conditioning.

Problem Statement

It is not uncommon in any industry for best practices to be set as a standard without evolution over time, even when those practices are, in the current environment, ineffective, inefficient, or even counterproductive. Homebuilding is no exception. A glaring example of a practice that has outlived its utility is the installation of the heating and cooling system in manufactured homes. By far, the most common scenario for heating and cooling design (about 90 percent of the roughly 105,000 manufactured homes produced each year) begins with the home manufacturers selecting inventory and installing components of the heating, distribution (typically air ducts), and ventilation systems in the plant. The second step is for a separate, unaffiliated, and independent entity—an HVAC distributor and installer—to design, select, and install other major system components (typically the cooling system) at the home site. Even though system efficiency and operating effectiveness require heating and cooling components to be integrated, the manufactured housing industry has made this bifurcated arrangement work. Experience has shown that fragmenting heating and cooling system decisions and outsourcing installation of important components to contractors outside the quality control reach of the plant (for manufactured homes, the quality control process is under HUD's purview) has a corrosive effect on system operational efficiency and durability, with corresponding negative impacts on affordability (that is, energy costs) and equipment service life.

Performance degradation that results from a fragmented heating and cooling system is neither modest nor uncommon. The following is a partial list of flaws and faults in heating and cooling system performance stemming from a split design and installation process that this article addresses.

- **Oversized Cooling Equipment.** Typically, the HVAC distributor working for the retailer selects cooling capacity, with no input from the manufacturer. The negative consequences of this disconnect are legion—manufacturers make decisions about other system components (for example, duct sizing) without knowing the capacity of the cooling equipment, and distributors tend to oversize cooling capacity, not knowing the efficiency of the envelope, wanting to avoid customer complaints about undercooling. Too often, antiquated rules of thumb are used in selecting cooling capacity. When cooling equipment is oversized, energy bills go up, and the system is less capable of controlling humidity levels, increasing the likelihood of moisture problems.
- **Mismatched Outdoor and Indoor Components.** Almost all manufactured homes are provided with cooling consisting of multiple site-assembled parts, including an evaporator “A” coil installed atop the furnace and an external compressor placed on a pad outside the home. The indoor and outdoor units must be matched to achieve the listed system efficiency (it is possible to physically combine indoor and outdoor products that are not meant to operate together). Mismatched products can lower operating efficiency (often significantly), create comfort issues, exacerbate indoor air quality-related moisture management issues from mismatched cooling products that cannot manage indoor humidity, especially in shoulder seasons,² or render the system unable to function, resulting in callbacks and costly equipment

² *Shoulder season* is a term referring to non-peak heating and cooling seasons. Spring and autumn are shoulder seasons.

replacements. Data collected from a utility-sponsored rebate program by Systems Building Research Alliance determined that about 10 percent of cooling system components are mismatched (Levy, 2022).

- **Incorrect Refrigerant Line Charge.** Achieving the listed efficiencies requires the technician to install and charge the refrigerant lines properly and the lines to be free of leaks. Lacking formal oversight, site installations may be under- or overcharged. Line charge issues will reduce operating efficiency and capacity, and leaks emit harmful greenhouse gases into the atmosphere.
- **Wrong Thermostat for Equipment Type.** The type of heating and cooling system will dictate the type of thermostat to be installed in the home. It is not uncommon for the manufacturer to install one type of thermostat and for the field technician to install one for a different product type (for example, the manufacturer expects an air conditioning system, but the technician installs a heat pump). The result is extra work, material cost, and, often, reduced functionality and energy waste.
- **Bottom Liner Tears.** Site installers may find it most convenient to run refrigerant lines through the flexible membrane covering the bottom of the home, creating tears. This damage happens late in the installation process, and the penetrations may never be discovered. If not repaired, the holes are pathways for air leakage and can create condensation inside the home. Leaks at penetrations between the floor decking and bottom liner can introduce contaminated air from crawlspaces into the home. Any condensation or associated mold in the belly or crawlspace can migrate into the home.
- **Misalignment of Service Responsibilities.** “Callbacks,” regardless of the cause, currently fall to the manufacturer to address. In the case of the heating and cooling system, the HVAC installer is not directly accountable. This lack of accountability is insidious in two respects. When failures occur, the feedback to the plant is, at best, indirect; as a result, systemic issues are difficult to pinpoint and resolve. Lacking commercial ties to the installer, manufacturers have few options for enforcing quality installation procedures. Fragmenting the installation process also creates consumer confusion when a repair is needed, as determining the responsible party whose warranty covers the repair work is often difficult.
- **Improper Configuration of Fresh Air Intake.** The fresh air intake duct is the ventilation system for many manufactured homes. Typically, the HVAC installer sets the intake position when the cooling coil is added in the field. Improper configuration compromises ventilation. Like other previous examples, the ventilation system is more prone to improper setup when performed outside the plant’s quality control process.

Factory-Complete Heating and Cooling Solutions

To explore the potential heating and cooling systems not currently used in the manufactured home industry, the authors surveyed industry stakeholders to identify options for factory-complete heating and cooling solutions, including associated advantages and barriers to their adoption (see appendix). In this first stage of the process, the focus was on identifying options and assessing

technical merits. The project's Technical Advisory Group, consisting mainly of senior engineering staff with leading home manufacturers, provided input for this phase. The authors assessed related market acceptance considerations in interviews with the Marketing and Commercialization Panel, emphasizing costs, servicing, and other business-related criteria.

Key technical considerations from the input of the project Technical Advisory Group follow.

- **Design Flexibility.** Most manufactured homes are either single-wides or double-wides (two sections joined together), and the heating and cooling system must work with both home types. Ductwork is also a key design consideration. Most manufactured home plants in the United States, especially in northern climates, use downflow ducts, whereas in the South, upflow ducts are sometimes used. Some heating and cooling equipment can accommodate both directions with a conversion kit. Restrictions on the placement of heating and cooling indoor and outdoor components, such as the need to be adjacent to an exterior wall, may limit floor plans for such solutions.
- **Sizing.** Manufactured homes range from less than 800 square feet to more than 2,500 square feet. The heating and cooling capacity range of a heating and cooling system will have to cover these different home sizes in a wide range of climate locations.
- **Efficiency.** Inefficient system operation is a major factor in high energy bills. Improving system efficiency can help homeowners save money.
- **Ease of Installation.** Speed of installation is critical to maintaining the factory production rate. A simpler installation process requires less time and labor. New skills might require additional investment in staff training and tools. The complexity and difficulty of the installation procedure may also increase the risk of system failure due to improper installation. The necessity of any onsite work will add expense.
- **Balanced Air Distribution.** The system must distribute conditioned air evenly across all bedrooms and main living areas.
- **Transportability.** The completed home might have to be shipped hundreds of miles without damage.
- **Testing and Commissioning Procedures for the System.** System testing and commissioning will fall under the plant's purview. The complexity and difficulty of the procedure may require training of new skills and added labor during production and, thus, can increase the cost to customers; however, the in-plant quality control process may reduce service calls. Savings from improved quality and operational efficiency may partially offset the added cost.
- **Associated Building Needs.** Some heating and cooling systems may have additional features that can satisfy other needs—for example, a built-in dedicated ventilation system.
- **Noise.** Noise from the indoor or outdoor unit should be tolerable for occupants.

- **Changes to the HUD Standards.** Given the range of technical options under current consideration, technology changes will likely be accommodated in the short term through the application for Alternative Construction letters. If the standards restrict the use of a proposed heating and cooling system change, a process must be initiated to propose changes in the regulations through the normal standards update process. In this study, only the Ephoca-made Packaged Terminal Heat Pump unit required an Alternative Construction letter because of abridged Air Conditioning, Heating, and Refrigeration Institute (AHRI) certifications.³
- **Aesthetics.** The appearance and location of the heating and cooling system must be acceptable to homeowners. The market prefers aesthetics comparable with site-built homes.

Current industry heating and cooling practices consist of installing a gas or electric furnace in manufactured home by the plant, with site-installed cooling components. Air distribution is typically accomplished by placing ducts in the attic or the conditioned floor cavity. For multisection homes, an externally installed crossover duct beneath the home usually connects the trunk ducts in each section. Cooling components are added at the site, usually consisting of an A-coil placed in the furnace cabinet connected with refrigerant lines running to an outside condensing unit (exhibit 1). A local contractor performs field installation. As noted previously, this configuration is susceptible to a rash of potential quality and performance failures.

Exhibit 1

Current Typical Heating and Air Conditioning Setup in Manufactured Homes

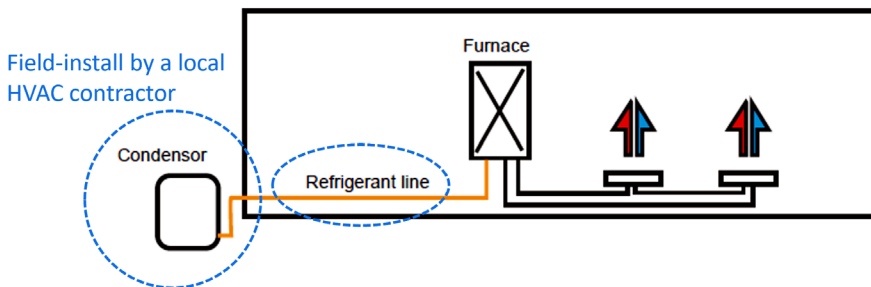

HVAC = heating, ventilation, and air conditioning.

Source: SBRA, Milestone Report: Identification and Selection of Factory Complete HVAC Solutions

In response, the industry has experimented with other approaches that put the installation of the key heating and cooling system components under the factory's auspices. As a first step in this project, to learn from previous efforts, the authors conducted a survey with industry experts and stakeholders to identify opportunities to advance the most promising practices and select the most promising ideas for further development. The survey and literature search identified the following options for in-plant completion of the heating and cooling system.

³ Ephoca is certified to AHRI 390 instead of HUD's requirement of AHRI Standard 210/240.

- **Type 1.** Split system with duct distribution; compressor mounted on frame.
- **Type 2.** Split system with duct distribution; compressor shipped loose, placed on pad at site.
- **Type 3.** Packaged unitary system (interior) with duct distribution.
- **Type 4.** Packaged unitary system (exterior) with duct distribution.
- **Type 5.** Ductless mini-split heat pump.⁴
- **Type 6.** Ducted mini-split heat pump.
- **Type 7.** Nonducted packaged heat pump.

Short List of Solutions

The Technical Advisory Group finalized the selection of the system options in a meeting that delved into the short-listed options, with the expectation that two to three of the options would be promoted for subsequent development. The discussion helped get every member on common ground and move toward consensus.

On the basis of the evaluation of the advantages and challenges of each of the seven options identified and with input from the project's Technical Advisory Group, the authors selected three options for continued consideration.

1. **Packaged Unitary System (Interior) with Duct Distribution (Type 3).** Type 3 is a fully self-contained unitary heat pump system inside the thermal envelope. These systems are popular in modular construction and hospitality buildings. Many years ago, a version of this concept was used in manufactured homes (the “insider” heat pump in exhibit 2). However, due to technical issues, low demand, and the amount of development needed to meet higher Seasonal Energy Efficiency Ratio (SEER) and Heating Seasonal Performance Factor (HSPF) ratings, that concept was abandoned (Lubliner, Hadley, and Parker, 2007). The Technical Advisory Group was interested in revisiting this approach with today's technology (exhibit 3).

⁴ *Mini-split system* here refers to a compact, high-efficiency heat pump with one or multiple indoor heads and one or more outdoor compressors.

Exhibit 2

The Insider Heat Pump

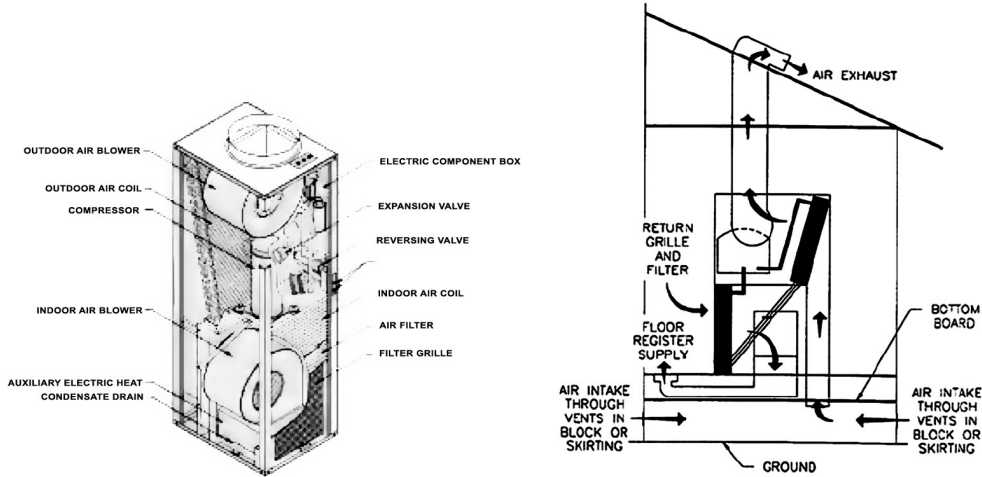

Source: Insider Service Manual (left); Lubliner, Hadley, and Parker, 2007 (right)

Exhibit 3

Packaged Unitary System (Interior) with Duct Distribution

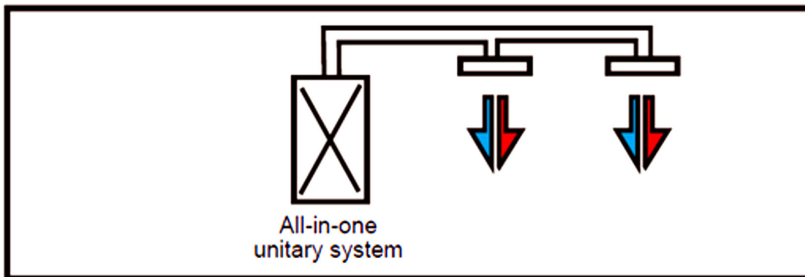

Source: SBRA, Milestone Report: Identification and Selection of Factory Complete HVAC Solutions

2. **Ducted Mini-Split Heat Pump; Compressor Mounted on Frame (Type 1 + 6).** This type is a combination of systems 1 and 6. The decision was made to use a ducted mini-split system instead of the conventional air conditioner or heat pump paired with an indoor electric or gas furnace. Mini-split systems are more energy efficient, and certain market segments in the industry already use them. Efficiency and industry usage made it more valuable to investigate. Ducted mini-split systems use inverter-driven compressors and variable-speed fans to optimize performance. The outdoor units are slimmer than conventional systems, which improves aesthetics (exhibit 4).

Exhibit 4

Ducted Mini-Split Heat Pump with Compressor Mounted on Frame

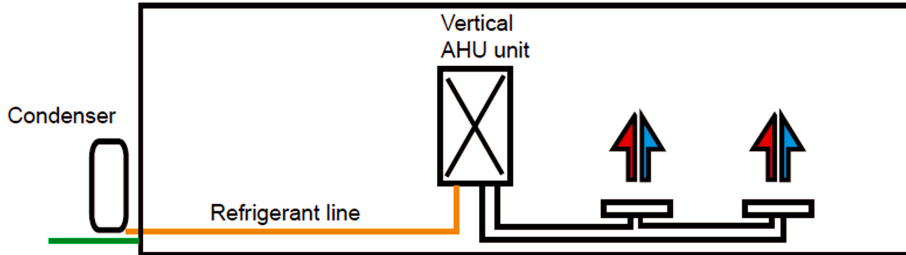

Source: SBRA, Milestone Report: Identification and Selection of Factory Complete HVAC Solutions

3. **Nonducted Packaged Heat Pump (Type 7).** Type 7 is a nonducted system that eliminates the design and installation of ductwork, which can be points of failure in current practice (exhibit 5). The unit to be demonstrated has high-energy efficiency due to its variable-speed, inverter-driven technology and, therefore, can provide lower monthly operating costs for homeowners. One unit is installed in each zone so the occupants can fully control which zone or room they would like to heat or cool.

Exhibit 5

Nonducted Packaged Heat Pump

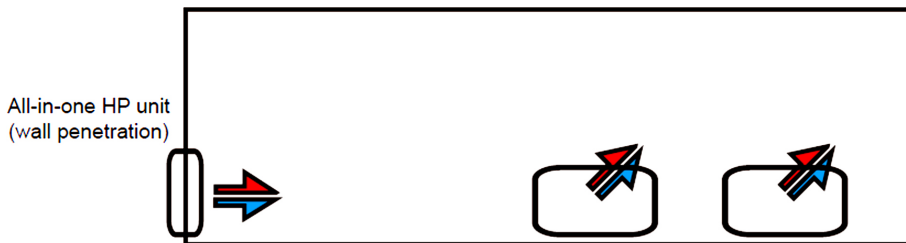

Source: SBRA, Milestone Report: Identification and Selection of Factory Complete HVAC Solutions

Each proposed system was incorporated into at least one home for testing purposes with industry partners.

Prototype Process and Findings

Integrating the full heating and cooling system installation in the manufactured home plant provides an opportunity to rethink current practice and potentially open new revenue opportunities for the factory.

The packaged unitary and ducted mini-split systems were prototyped in March 2022 in partnership with the Clayton Homes plant in Waycross, Georgia. The nonducted packaged system is scheduled to be prototyped in late 2022 at the Karsten-Clayton Homes plant in Sacramento, California; therefore, production processes and findings were not available at the time of this publication.

The heating and cooling systems used are listed as follows.

- Packaged unitary ducted system: Friedrich, model VRP36K10.
- Ducted mini-split heat pump: LG, model LUU249HV (outdoor) and LVN241HV4 (indoor).
- Nonducted packaged heat pump: Ephoca, model DP91HDSO.

The following section discusses, for each system, the added work to home production, ease of system installation, short-term performance evaluation, transport to a site, servicing arrangements, and cost.

Packaged Unitary System

A high-efficiency packaged unitary heat pump was installed in a double-section home with an air grille on an exterior wall (Friedrich VRP36K10) at the Clayton Homes plant in Waycross, Georgia.

Implementation Process

The packaged heat pump must be located at an exterior wall to exchange air and heat with the outdoors. The end wall of the home is preferable to a side wall to provide adequate clearance in the attic for connection to the attic trunk duct. A rough opening must be provided in the wall and a plenum sleeve and louver installed to trim out the opening (exhibit 6). The U_o value will slightly increase (0.3 percent) due to the home's louvered area (about 12 square feet).⁵

⁵ Per the Restoration Dictionary, "The 'U_o value' is the overall coefficient of heat transmission of the manufactured home based on the respective thermal zone location and an indoor design temperature of 70° F, and is defined in units of BTU/(hour)(square foot)(°F)."

Exhibit 6

Floor Plan of the Double-Section Home with Friedrich VRP Heat Pump

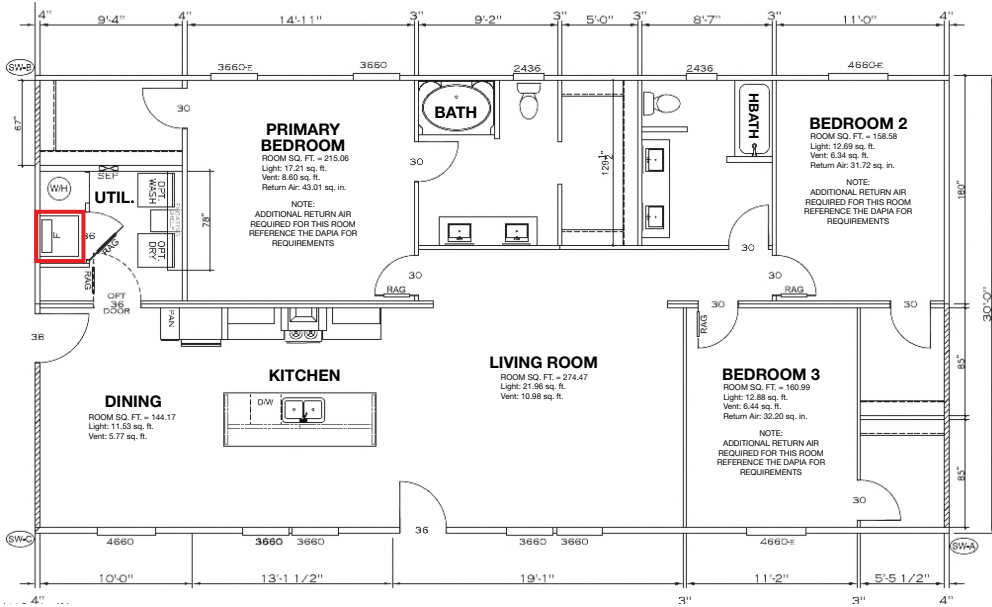

Source: Clayton Homes

The packaged unit is then connected to the overhead ductwork and wired to the electrical panel, the condensate line connected to the heat pump, and the unit connected to a wall-mounted thermostat (exhibit 7).⁶ No transport protection measures are needed because the unit is fully secured in place and inside the thermal envelope. The entire system is within the thermal envelope; thus, it is less prone to vandalism and floods (exhibit 8).

⁶ Currently, only upflow air configuration is available so this packaged unit can be used for homes with attic ducts but not under-floor ducts.

Exhibit 7

Construction of the Exterior Wall Opening



Source: SBRA, Milestone Report: Factory Construction Process and Results

Exhibit 8

Final Setup of the Friedrich Unit



Source: SBRA, Milestone Report: Factory Construction Process and Results

Benefits

1. **Little Additional Work Needed.** This packaged system requires little additional work because no separate outdoor unit is present. The entire system is mounted inside the home adjacent to an exterior wall, through which it exchanges air and heat with the outdoors. Thus, the only additional work required is to provide an exterior wall rough opening and install a sleeve and louver to cover the opening. A drain pan and drip ledge are equipped in the unit to plumb any excess water driven from wind, rain, and ice through the louver.

2. **Does Not Require an Alternative Construction Letter.** An Alternative Construction letter is not required. Per HUD Code 3280.703, the AHRI 210/240 listing (for the single-packaged air-source heat pump) held by this product is compliant. This system is mandated to use low-global warming potential refrigerants starting in 2025.
3. **Aesthetics.** This system will have a flat grilled louver on the end wall. It does not have an outdoor unit that is high up on the wall, which the customer disliked.

Challenges

1. **Floor Plan Design Inflexibility.** This system must be installed against an exterior wall to exchange air with the outdoors. The end wall of the home is preferable to a side wall because the attic has adequate clearance for connection to the attic trunk duct. At the Waycross plant, of their 10 floor plan designs, only 1 design could accommodate the packaged unit installation without significant modification.
2. **Limited Airflow Options.** The packaged system is limited to upflow configuration and, therefore, only suitable for overhead ducts. Future models may be available with side discharge, which may be suitable for in-floor duct systems.
3. **Narrow Capacity Range.** The maximum capacity is approximately 3 tons for the packaged system, which can be too small for homes larger than the prototyped double-wide home (1,800 square feet) or homes in cold climates. The average multisection home built in 2021 was 1,794 square feet. Assuming that roughly one-half of multisection manufactured homes exceed this size and no single-section homes do, then roughly 30 percent of the manufactured homes shipped in the United States in 2021 exceeded 1,800 square feet (MHI, 2022). About 20 percent of the manufactured homes shipped in the United States in 2021 were shipped to HUD climate zone 3—the coldest zone (MHI, 2022). Data cross-referencing size and location are unavailable, so this scenario is a worse-case estimate of homes unsuitable for a 3-ton system. Although an electric heat strip can be added to the system to compensate for the capacity limitation, it is not an ideal solution from an efficiency standpoint. Improving the thermal envelope U_o value might be a better way of mitigating the heating load.
4. **Higher Price.** Although easier installation means less labor, the equipment is more expensive than a standard split system (a roughly 40- to 50-percent increase in equipment cost).

Attic-Ducted Mini-Split Heat Pump

A high-efficiency split heat pump was installed in a single-section home with outdoor portion mounted on a home chassis extension and the air handler located in an interior closet (LG LV241HV4) at the Clayton Homes plant in Waycross, Georgia (exhibit 9).

Exhibit 9

Floor Plan of the Single-Wide Home with LG Ducted Mini-Split Heat Pump

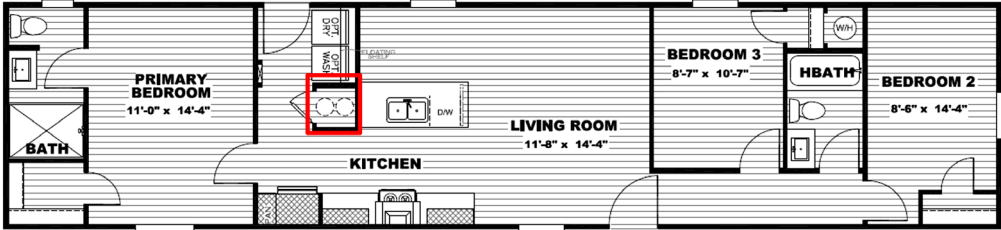

Source: Clayton Homes

Implementation Process

To securely mount the outdoor unit to the exterior of the home, a metal frame was welded to the home chassis. The design was based on Clayton's other mount-on-frame projects (mostly for mini-split systems) and adjusted to the dimensions of the LG system. This redesign had to be submitted to the Design Approval Primary Inspection Agency—Hilborn, Werner, Carter & Associates, Inc. (HWC)—for approval (exhibit 10).

Exhibit 10

Frame Extension Design Approval

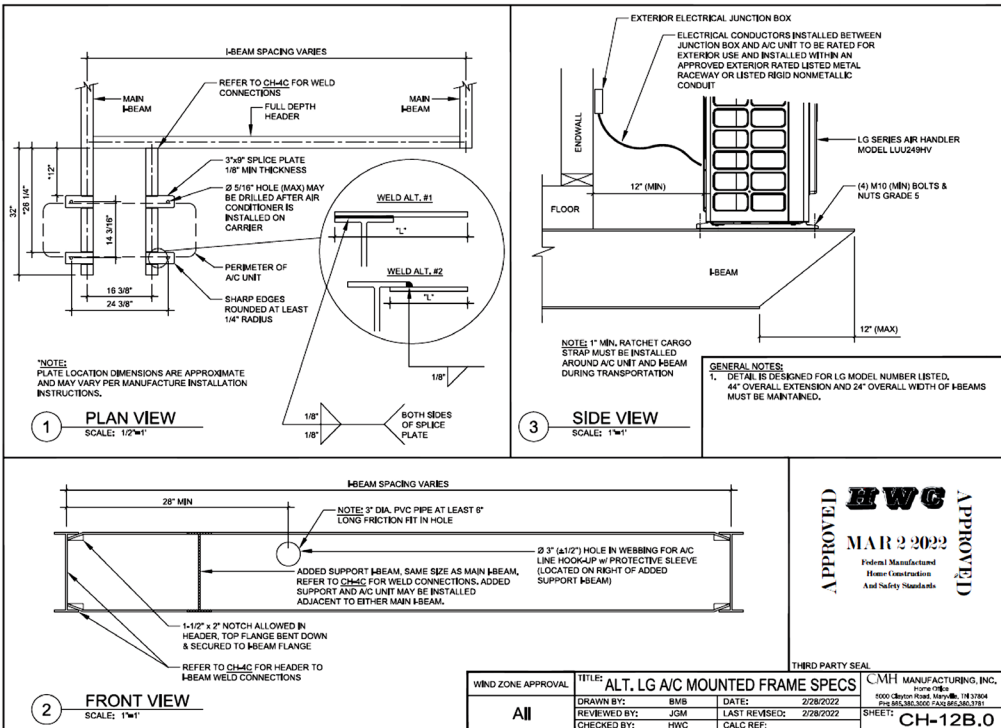

Source: Clayton Homes

An I-beam header was installed on the rear of the home spanning between the main I-beams, and two metal plates were welded to the header (exhibits 11 and 12). A 4-inch hole was punched through the rear header to run a polyvinyl chloride, or PVC, pipe to protect the refrigerant line. The pipe is 4 inches in diameter and runs from the floor under the indoor unit to the outdoor unit.

Exhibit 11

Welding Frame Extension to Rear Header for the LG Outdoor Unit

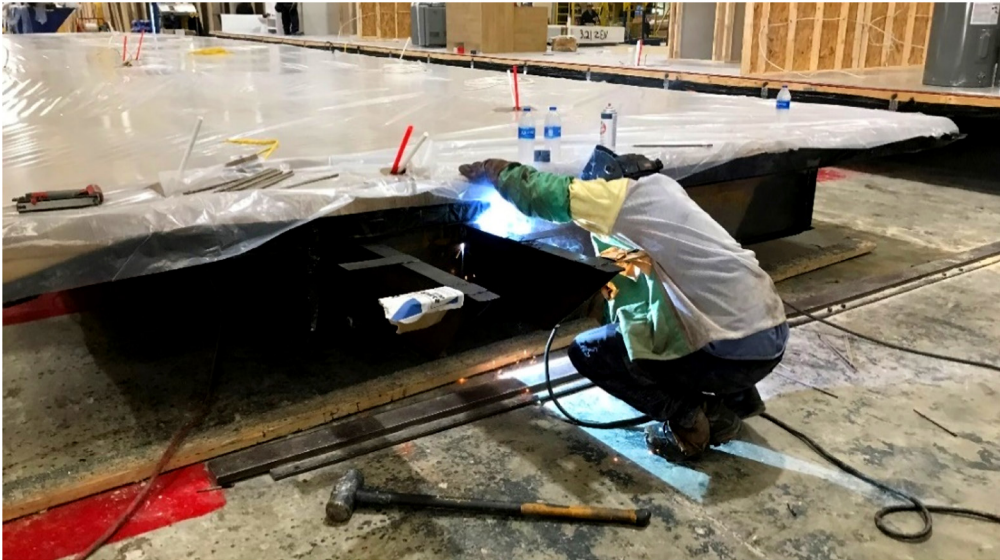

Source: SBRA, Milestone Report: Factory Construction Process and Results

Exhibit 12

Four-Inch PVC Pipe Protection for the Refrigerant Line Set for the LG System



Source: SBRA, Milestone Report: Factory Construction Process and Results

The indoor air-handling unit (AHU) was then connected to the overhead ductwork. The prototype home has upflow air ductwork, but the vertical AHU can also be converted to serve ducts under the floor (exhibit 13). The outdoor unit was then wired to the electrical panel. The indoor unit gets power from the outdoor unit. Finally, the condensate line was connected, and the AHU was wired to a wall-mounted thermostat. After securing the outdoor unit to the platform and connecting the refrigerant line set to the ports, a leakage and evacuation test was performed (exhibit 14). Because the line length exceeded the precharged refrigerant length maximum, a small amount of additional refrigerant was added.⁷

⁷ For the prototyped LG unit, the outdoor unit holds a precharged refrigerant volume enough to run up to 24.6 feet.

Exhibit 13

LG Heat Pump Air Handler Downflow Configuration and Conversion Kit

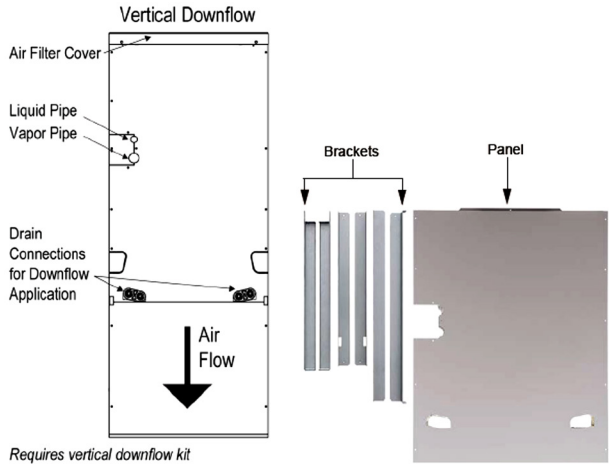

Source: LG Vertical Air Handling Unit Downflow Conversion Kit Installation Manual

Exhibit 14

Refrigerant Line Leakage Test of LG Heat Pump



Source: SBRA, Milestone Report: Factory Construction Process and Results

Benefits

1. **Great Energy Performance.** The efficiency of the ducted mini-split system is superior to the standard split system heat pump that the plant typically uses (SEER 14, HSPF 8.2). The variable-speed LG unit has a SEER of 18 and HSPF of 10 for a 3-ton unit, and a SEER of 19.5 and HSPF of 11 for a 2-ton unit. Ducted distribution, however, reduces efficiency and capacity somewhat compared with ductless units.
2. **Does Not Require an Alternative Construction Letter.** An Alternative Construction letter was not required for the LG unit. Per HUD Code 3280.703, the AHRI 210/240 listing is acceptable for the air-source heat pump. This system is mandated to use low-global warming potential refrigerants starting in 2025.
3. **Quiet.** The indoor AHU unit provides a very quiet operation of about 50 A-weighted decibels (dBA) compared with a traditional furnace air handler (61 to 68 dBA). The U.S. Environmental Protection Agency (EPA) identified an average 24-hour exposure limit of 45 dBA for indoor residential areas to provide comfort and protect the health of occupants (EPA, 1974).
4. **Floor Plan Design Flexibility.** The ducted mini-split unit offers more flexibility on floorplan designs. The indoor unit fits into the typical furnace closet. The indoor AHU can be anywhere on the floor plan if the refrigerant line does not exceed a certain limit.⁸ However, if additional refrigerant is not added to the system, the lines can only run a limited distance (about 25 feet).
5. **Airflow Configurations.** The indoor AHU can be converted to serve in-floor ducts—the most common duct configuration in the industry—with a downflow kit (\$150 to \$200). Attic ducts are more typical in the South. The downflow configuration does not affect floor location or space requirements.

Challenges

1. **New Skills and Additional Work Needed.** A split system, such as the ducted mini-split unit, requires that the installer hold an EPA refrigerant handling license, which the plant does not typically hold. Additional work includes connecting the lines, evacuation and vacuum testing, charging, and protecting the refrigerant lines. Plants would also have to track inventory for the additional parts and materials that are required. Additional tools are necessary to complete those tasks (for example, a pressure gauge and a vacuum pump).
2. **Adding Total Length to the Home.** Adding the frame extension to accommodate the outdoor unit increased the total home length by 32 inches. On a home already designed to the maximum length allowable by shipping regulations or factory constraints, this increase is a limitation.
3. **Aesthetic Issues.** The frame extension and outdoor unit affect aesthetics because they are positioned higher than the typical outdoor unit equipment pad mounted on the ground. The elevation can be especially high on a sloped site and could affect serviceability. However, higher outdoor units are typically less prone to floods, winds, and vandalism.

⁸ The LG outdoor unit that was installed can reach a maximum length of 164 feet.

Design and Commercial Practice Changes

Key players in the heating and cooling selection, design, and installation processes will likely change as the project results are deployed. In the future, the manufacturer will take on most of the responsibilities, revamping and replacing steps currently under the purview of the HVAC distributor or site technician.

Current Commercial Setup

The current commercial setup associated with heating and cooling selection, design, and installation in the manufactured housing industry has stayed the same for decades. The plant installs only the indoor furnace (electric or gas) and ductwork, whereas the retailer orders the outdoor unit (air conditioning only or heat pump) from the HVAC distributor. The distributor then sends a technician or contractor to the site to install the coil and outdoor unit. These affiliated contractors are also responsible for future servicing if the outdoor unit fails. Use of the alternative heating and cooling systems that are fully installed in the plant will require commercial arrangement and business relationship changes, as the following section describes.

Current State

Two major paths to selling a manufactured home exist: via retailers or via manufactured housing communities. In both scenarios, the HVAC distributor, retailer, or contractor plays a critical role in providing, installing, and servicing the outdoor equipment (and coil). For servicing, the homeowner or resident calls the retailer, and, depending on the type of system failure, the retailer finds the right party to service the system.⁹ The following is a list of parties responsible for different activities of the heating and cooling processes.

- Distribution of equipment: Original equipment manufacturer (OEM) (both indoor and outdoor); HVAC distributor (outdoor).
- Equipment stocking: Plant (indoor); HVAC distributor (outdoor).
- Installation: Plant (indoor); local HVAC contractor (outdoor).
- Service, warranty, and repair: Local HVAC contractor.

The diagram in exhibit 15 captures the current state of financial relationships in the heating and cooling processes for homes in scattered lots and communities. The OEM sells some equipment to the manufactured home plant and the balance to an HVAC distributor. These parallel streams recombine at the site when the retailer or community purchases them and they are delivered to the customer.

⁹ An indoor unit is the plant's responsibility, and an outdoor unit and coil are the HVAC distributor's responsibility.

Exhibit 15

Current State Model (Scattered Lot and Communities)

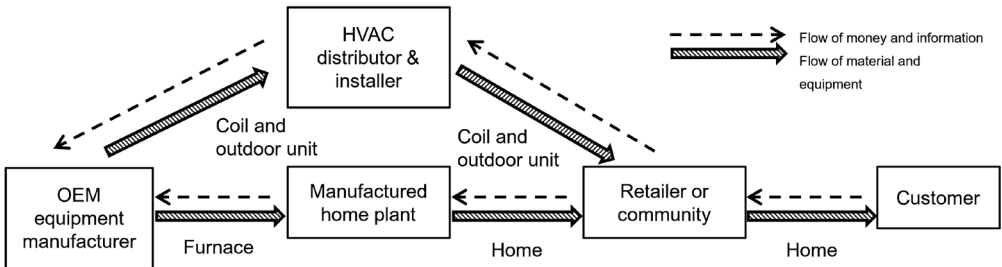

HVAC = heating, ventilation, and air conditioning. OEM = original equipment manufacturer.
 Source: SBRA, Milestone Report: Cost Assessment Report

Future State—Full Heating and Air Conditioning System Installed by the Plant

In the future, most of the responsibilities will be moved to the plant. All heating and cooling components would be provided directly to the plant. The in-plant quality control process may reduce service calls, and savings from improved quality and operational efficiency may partially offset the added cost. The following is a list of parties responsible for different activities of the heating and cooling processes.

- Distribution of equipment: OEM or HVAC distributor (indoor and outdoor).
- Equipment stocking: Plant or HVAC distributor.
- Installation: Plant.
- Service, warranty, and repair: Local HVAC contractor, plant, or HVAC distributor.

Exhibit 16 captures the financial relationships of the heating and cooling processes of the future state. The flow is streamlined, with all heating and cooling equipment passing from the OEM manufacturer to the manufactured home plant to the site.

Exhibit 16

Future State Model

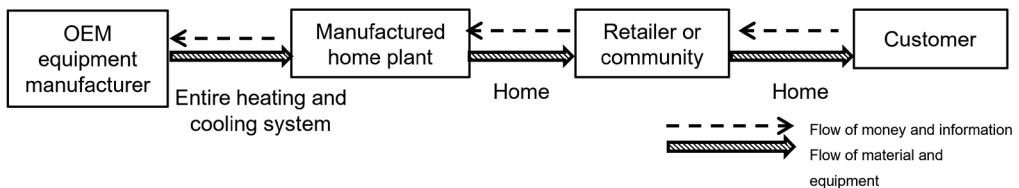

HVAC = heating, ventilation, and air conditioning. OEM = original equipment manufacturer.
 Source: SBRA, Milestone Report: Cost Assessment Report

To further understand the commercial benefits and liabilities of each system, a list of evaluation criteria was divided into the categories **More Critical** (exhibit 17) and **Less Critical** (exhibit 18) to the Industry on the basis of input from the Marketing and Commercialization Panel, which comprises manufactured home sales and marketing directors, home installation specialists, and HVAC sales representatives.

Exhibit 17

List of Evaluation Criteria—More Critical to the Industry

Market Considerations	Packaged Unitary, Ducted Unit	Mini-Split, Ducted Unit	Packaged Unitary, Nonducted Unit
Material and component costs	Approximately \$3,700–\$4,300 increase from current practice (cost to the retailer).	Approximately \$1,200–\$1,500 increase from current practice (cost to the retailer).	Approximately \$8,000–\$9,500 increase from current practice (cost to the retailer).
Service costs	Warranty is included but only up to 1 year. Labor included only for the first year.	Need to pay an upfront cost for a 10-year warranty (approximately \$400).	Warranty is included for up to 10 years (parts only). Labor included only for the first year.
New inventory procedure	Equipment stored in the plant.	Equipment stored in the plant.	Equipment stored in the plant.
Region marketability	Not flexible. Currently, available only in homes with upflow air ducts (mostly produced for HUD climate zone 1).	Flexible. The air handler can serve both up- and downflow air.	Flexible. Zonal system.
Impact on existing business relationships	Large impact—will need to change supplier and possibly cut out heating, ventilation, and air conditioning distributors from the value chain currently in close relationship with the retailers. See the previous section on business relationship change.	Current supplier (HVAC distributors or OEMs) might be able to provide a similar product. See the previous section on business relationship changes.	Large impact—will need to change supplier and possibly cut out HVAC distributors from the value chain, currently in close relationship with the retailers. See the previous section on business relationship changes.
Process for system maintenance and service at the site	National footprint might be limited because the system type is less common. Need skills and expertise to do maintenance.	Might not be an issue. However, if local HVAC contractors were to perform the servicing, they might be reluctant because of making less money: installation would be removed from their contract.	National footprint will be limited because the system type is very new, and currently, only a handful of manufacturers produce this type of system. Skills and expertise are needed to perform maintenance.

Source: SBRA, Milestone Report: Cost Assessment Report

Exhibit 18

List of Evaluation Criteria—Less Critical to the Industry

Market Considerations	Packaged Unitary, Ducted Unit	Mini-Split, Ducted Unit	Packaged Unitary, Nonducted Unit
Availability of component parts from multiple suppliers	Component parts from multiple suppliers might be limited because the system type is less common.	Not an issue.	Component parts from multiple suppliers might be limited because the system type is less common.

Source: SBRA, Milestone Report: Cost Assessment Report

The cost to the plant and to the retailer of the prototyped systems were compared with a baseline system, a traditional split heat pump unit, to highlight the system upgrade cost (exhibits 19 and 20).

Exhibit 19

Estimated Costs to the Plant of the Prototyped Heating and Air Conditioning Systems

System Description	Cost to Plant	
	Materials	Labor
Baseline—Traditional split system that includes indoor furnace, connection to ductwork, and thermostat. Procurement and installation of outdoor unit not included.	\$796 (not including outdoor unit)	\$105 (not including installation of outdoor unit)
Friedrich home that includes packaged heat pump, connection to ductwork, and thermostat.	\$5,952	\$135
LG home that includes indoor air-handling unit, outdoor unit, connection to ductwork, and thermostat.	\$4,109	\$210

Source: SBRA, Milestone Report: Cost Assessment Report

Exhibit 20

Estimated Costs to the Retailer of the Prototyped Heating and Air Conditioning Systems

System Description	Cost to Retailer
Baseline—Traditional split system that includes indoor furnace, outdoor heat pump, connection to ductwork, and thermostat.	\$5,050
Friedrich home that includes packaged heat pump, connection to ductwork, and thermostat.	\$9,345
LG home that includes indoor air-handling unit, outdoor unit, connection to ductwork, and thermostat.	\$6,452

Source: SBRA, Milestone Report: Cost Assessment Report

Technical Advisory Group members and the Marketing and Commercialization Panel believed that the first cost to the homeowner was an important consideration. The heating and cooling equipment cost, if included, can add \$2,000 to \$6,000 to the home's retail price, which is challenging for an affordable housing product.

Feedback from the Industry

On the basis of the findings, the Technical Advisory Group discussed improvements that could be made in the system designs and integration into the home. Exhibits 21 and 22 describe the design and commercial hurdles encountered and their corresponding solutions.

Exhibit 21

Design Hurdles and Solutions	
Hurdles	Solutions
1. Floor plan design inflexibility	<p>For the packaged unitary system, overcoming the hurdle of floor plan design flexibility will be difficult because it must be on an exterior wall. The best solution is to design the mechanical room at the end wall housing the packaged unit.</p> <p>To avoid adding refrigerant to the ducted mini-split unit, limit line length to 25 feet.</p>
2. Limited airflow options	<p>A side-discharge supply air configuration must be developed for the packaged unitary system to direct air down to ducts under the floor.</p>
3. System capacity limitation	<p>For the packaged unitary system, the heating and air conditioning manufacturer will need to increase the capacity range of the unit, especially for homes larger than 1,800 square feet (about 30 percent of the homes shipped in 2021) or homes in HUD climate zone 3 (about 20 percent of the homes shipped in 2021) (MHI, 2022).</p>
4. New skills and additional work needed	<p>For the ducted mini-split unit, an installer with the U.S. Environmental Protection Agency Section 608 Technician Certification (Type II for residential air conditioning and heat pump) is required to do the connecting, evacuation and vacuuming, and charging of refrigerant. The plant will have to provide a training program for staff to develop the required skillset.</p>
5. Mount-on-frame will add to the total length of the home	<p>If the home is already designed to the maximum length allowable by factory constraints, the length added to the end of the house may exceed the limitation of the production line. One solution is to weld the extension frame at the final station so the added length will not block the line. If the home is already designed to the maximum length allowable by factory constraints, the length added to the end of the house may exceed the limitation of the production line. One solution is to weld the extension frame at the final station so the added length will not block the line.</p>
6. Aesthetic issues	<p>For the ducted mini-split unit, the outdoor unit is hard to conceal because it is mounted on the frame. One possible solution to this dilemma is to use a bolt-on option and relocate the unit to the ground on site; one can build a shroud around the unit or adopt shade landscaping to hide the equipment from sight.</p>
7. Floods, other damage, and vandalism	<p>The packaged unit is within the thermal envelope; thus, it is less prone to floods, fire, wind damage, and vandalism. The mount-on-frame system is high off the ground, reducing the risk of flooding. Specific protection can be provided to prevent wind damage and vandalism of the outdoor unit, such as covering it with a tarp during strong wind and locking the disconnect box to prevent theft.</p>

Source: SBRA, Milestone Report: Factory Construction Process and Results

Exhibit 22

Commercial Hurdles and Solutions

Hurdles	Solutions
1. Higher equipment cost	The current baseline system cost results from a years-long negotiation to reach the current price. Bulk purchase and further negotiations may be able to drive down the cost of the new systems.
2. Servicing arrangement and cost	A service network affiliated with the HVAC manufacturers would provide servicing for the new proposed approach. National coverage is crucial because manufactured homes are shipped throughout the United States. To expand the existing network, partnership with other servicing programs may also be a solution. For example, LG has a partnership with JB Warranties that provides certified servicing.
3. Impact on existing business relationships	If HVAC manufacturers or HVAC OEMs provide the equipment, the HVAC distributors may be removed from the business relationship because home manufacturers could assume those responsibilities. However, the HVAC distributors could still sell the equipment to the home manufacturers, and the plant could install it. The retailers have an established relationship with the HVAC distributors, which they might be reluctant to change.
4. Availability of component parts from multiple suppliers	For reliability, having multiple suppliers to provide the components is always better than relying on a single supplier.

Source: SBRA, Milestone Report: Factory Construction Process and Results

Conclusions

Of the two systems, plant management appreciated the ease of installation of the packaged unit but noted that equipment cost might be a hindrance. The ducted mini-split system has superior energy performance and is competitive on cost, but the additional work associated with the installation and commissioning is a major drawback. Both systems showed that they could be fully integrated into the homes’ construction process, be soundly transported to the site, and meet the performance evaluation and operational expectations.

This study, however, has revealed some stumbling blocks—in the technical and commercial aspects—that require further effort to resolve. Those hurdles include higher equipment costs, limited airflow options, new skills and additional work needed, and changes to existing business relationships. Additional future research and fieldwork are needed to probe the technical hurdles. HVAC manufacturers and products also need to offer more competitive costs to incentivize the plants to adopt the factory-installed heating and cooling components concept. Future discussions should also be held with the HVAC distributors to explore collaboration possibilities further. Resolving those problems can help make manufactured homes more affordable on a sustained basis and improve quality and resilience.

Acknowledgments

The project team thanks the many people from the Clayton Homes family who built, hosted, and assisted with the design and installation of the prototyped units, including John Weldy, Scott Rainwater, Darlene Fesperman, and the staff of Clayton Homes. Special thanks to the committee of industry representatives who provided ideas for and feedback on approaches to developing advanced building techniques that have both commercial and energy savings potential. The team also thanks the product suppliers, who provided timely technical support and donated materials and products for the tests: Terrance Frisenda and Phillip Kriegbaum of LG and Jerad Adams and Bascom Cotner from Friedrich. Thanks also to Don Shiley of Electric Power Research Institute, who provided valuable support and performed monitoring of the test homes.

The authors gratefully acknowledge the financial support from HUD for this research under grant number H-21688 CA. Further thanks go to Mike Blanford for managing and coordinating this work on HUD's behalf. Finally, the authors thank the editors and two referees for their helpful comments.

Authors

Emanuel Levy, Executive Director; Jordan Dentz, Senior Program Manager; and Yi-Jia Liao, Project Manager are from System Building Research Alliance, a nonprofit organization with a mission of improving the performance and value of the nation's factory-built homes.

Appendix

Exhibit A1

Technical Panel Members	
Panel Member (Interviewee) Title	Expertise
Director of Engineering	Manufactured home systems design and engineering
Vice President of Engineering	Manufactured home systems design and engineering
Chief Engineer	Manufactured home systems design and engineering
Director of Production	Production flow, home manufacturing efficiency
Vice President of Engineering and Design	Manufactured housing heating, ventilation, and air conditioning systems and production

Source: SBRA, Project Narrative

Exhibit A2

Commercialization Panel Members

Panel Member (Interviewee) Title	Expertise
Retail Regional Director	Manufactured home sales and marketing
Vice President of Site Construction	Home installation specialist
Associate Director	Heating, ventilation, and air conditioning sales and marketing
Senior Manager of Product Management	Heating, ventilation, and air conditioning sales and marketing

Source: SBRA, Project Narrative

References

- Dentz, Jordan, and Shengming Zhu. 2021. *An Approach to High-Performance Affordable Housing Using Point-Source Space Conditioning*. New York, NY: U.S. Department of Energy, Office of Energy Efficiency and Renewable Energy.
- Levy, Emanuel. 2022. TVA Rebate Program, Systems Building Research Alliance.
- Lubliner, Michael, Adam Hadley, and Danny Parker. 2007. "HVAC Improvements in Manufactured Housing Crawlspace-Assisted Heat Pumps," *ASHRAE Transactions* 113 (2): 70–76.
- Manufacturing Housing Institute (MHI). 2022. "2022 Manufactured Housing Facts: Industry Overview." <https://www.manufacturedhousing.org/wp-content/uploads/2022/04/2022-MHI-Quick-Facts-updated-05-2022-2.pdf>.
- Talbot, Jacob. 2012. *Mobilizing Energy Efficiency in the Manufactured Housing Sector*. Washington, DC: American Council for an Energy-Efficient Economy.
- U.S. Environmental Protection Agency (EPA). 1974. *Information on Levels of Environmental Noise Requisite To Protect Public Health and Welfare with an Adequate Margin of Safety*. Washington, DC: U.S. Environmental Protection Agency.

Exploring the Potential of Factory Installed Solar + Storage for Homebuilding

Isabelina Nahmens
Ondřej Labík
Louisiana State University

Alison Donovan
Kalee Whitehouse
Damon Lane
Desmond Kirwan
Leslie Badger
VEIC

Ankur Podder
Shanti Pless
National Renewable Energy Laboratory

Abstract

In recent years, an increasing number of grid disruptions due to intense weather events, natural disasters, and high peak loads resulted in increased interest in energy-resilient homes. Solar + storage (S+S) as an energy resiliency solution can provide continuity, onsite generation, and backup power during critical events. This project explored factory-installed solar plus storage (FISS)¹ to overcome first cost and installation barriers and bring this resiliency solution to scale for single-family affordable and market-rate homebuyers. Guided by the principles of Lean manufacturing,² the team explored how factories building high-performance zero energy modular³ homes can incorporate S+S into their existing construction system while improving quality and productivity and reducing the costs of the resilient energy system.

¹ Factory-installed solar plus storage is the study approach of installing solar panels systems, including a battery in modular homes at the factory.

² Lean manufacturing is a production process based on maximizing productivity while minimizing waste.

³ Zero energy modular homes are homes that combine the cost savings of modular construction with the benefits of zero energy.

Abstract (continued)

The team identified both potential barriers (for example, first cost, permitting, utility interconnection, finished module transportation, and future battery replacement) and value (such as, resiliency benefits, opportunities for utilities, clean energy equity for affordable housing, and new markets for modular factories) of incorporating S+S into factory-built housing. Through a case study and factory information modeling, the team analyzed the FISS approach, which resulted in about 27 percent potential total cost reduction compared with onsite installation. Using the cost reduction results from the case study, the team evaluated the homeowner economics and duration of backup power using the National Renewable Energy Laboratory's (NREL) System Advisor Model (SAM)⁴ in six locations in the United States. Results showed that in five locations, homeowner net present value (NPV)⁵ is positive with long-term, low-interest financing through a mortgage. The SAM analysis showed in almost all cases, the S+S system could power 25 percent of the electricity needed in a home for 4 days, and under some scenarios, up to 100 percent of the load for 4 days. Findings from this study show S+S is a viable backup power source during grid outages and supports the creation of a high-performance factory to produce resilient homes that can be adopted at scale, with reduced cost by integrating S+S with prefabricated modules guided by lean manufacturing⁶ principles.

Introduction

The aim of this study was to create a resilient home product that can be adopted at scale, with reduced cost by integrating S+S with prefabricated modules guided by lean manufacturing principles.

Significance of the Work

In the past few decades, more frequent and intense weather events, higher peak loads, and natural disasters that create power outages have increasingly tested the electric grid in the United States. Without power, businesses, industry, and schools are disrupted, leading to economic losses and health and safety risks. To date, most aspects of resilient design have focused on construction methods that can withstand severe weather with high winds or flooding. Partnering with modular factories that already build high performance zero energy modular homes to incorporate solar + storage (S+S) into their existing construction system will provide energy resilience, continuity, and backup power during critical events (Green Mountain Power, 2018). In 2019, the U.S. Department of Housing and Urban Development (HUD) tasked Home Innovation Research Labs with creating a set of Residential Resilience Guidelines for Builders and Developers and identified the need to include onsite renewable power generation, grid independence, and grid interaction as resiliency measures (Home Innovation Research Labs, 2019). Factory-installed solar plus storage (FISS) has the potential for broad adoption if promoted by voluntary resiliency standards, such

⁴ System Advisor Model is a free technology-economic software developed by NREL to model performance and financial estimates of energy cost for grid-connected photovoltaic systems.

⁵ Net present value is a method to calculate the current value of a future stream of payments from an investment.

⁶ Lean manufacturing is a production process based on maximizing productivity while minimizing waste.

as FORTIFIED™⁷ and RELi.⁸ Shorter process for customers to research, financing, permitting, and lengthy applications. If factories included S+S as an option in standard home designs, FISS would reduce the decisionmaking complexity of the process from a customer perspective, help facilitate the integration of resiliency measures in home design under a controlled environment, while also reducing costs and providing continuity, onsite generation, and support during critical events.

How this Effort Will Change Homebuilding

Current research efforts show that inefficient construction processes are a major factor in the high cost of construction (Feldman et al., 2020). The homebuilding process needs to change, and factory-built homes are already well positioned to achieve more efficient processes by design and construction. Factory-built homes can also help facilitate the integration of resiliency measures (for example, S+S) under a controlled environment, leveraging integrated design, using assembly line techniques and factory employees (trained, scheduled, and managed by one employer). According to a recent report by McKinsey & Company, prefabricated assembly of modular buildings has demonstrated up to 20 percent cost savings and 50 percent construction time savings and is being looked to as a proven “affordability through innovation” method to increase productivity and significantly reduce construction costs (Bertram et al., 2019). Redesigning factory processes according to lean manufacturing principles while integrating S+S can reduce inefficiencies in the production process, minimizing those initial costs. Currently, modular factories, the solar industry, or storage providers do not widely understand knowledge on FISS and its lean benefits. New quality control methods can support FISS at the plant. As construction costs decrease, energy-efficient and resilient homes will become more desirable and widespread.

This project aims to analyze the economic benefits of FISS and explore the market to create a resilient home product that factories can adopt at scale, with reduced cost by integrating S+S with modular construction guided by lean manufacturing principles. Results from this project set forth a new strategy for resilient construction to all-electric zero energy modular homes and redesigning resilient power systems from backup diesel generators to S+S.

Anticipated Changes Needed To Bring FISS to Scale

Business as usual in the construction and homebuying processes will need to change to support the widespread adoption of FISS. Streamlining and standardizing building codes, inspection, and permitting processes will be crucial for the market adoption of S+S technologies. In addition, homeowners need access to mortgages that meet the payment schedules of modular housing and appraisals that recognize and understand the value of S+S. Utilities will need to support S+S with interconnection and net metering. The critical need is for existing and new factories to be willing to build a zero-energy standard and offer FISS as a standardized product to homebuyers.

⁷ FORTIFIED is a voluntary resilient standard that the Insurance Institute for Business & Home Safety developed and designed to be resilient to hurricanes, high winds, and hail.

⁸ RELi (Resilience Action List) is a voluntary resilient standard developed to increase adaptability and reduce sensitivity to hazards for building occupants.

Why HUD Funding Was Needed

This project builds on past HUD funding to further lean manufacturing principles in offsite construction, and more funding is required to explore expanding resilient homes to include resilient power systems. Unlike other federal agencies, HUD funding supports applied research in the cross section of housing, energy, affordability, resiliency, quality, and labor safety. Outcomes are actionable, and evidence-based recommendations to enable the homebuilding industry to work toward The HUD Offsite Construction Research Roadmap⁹ include S+S in voluntary resiliency standards financing to promote and support S+S in new homes. The study contributes to a better understanding of the usability of resilient technologies and eases the transition toward implementing resiliency criteria into every home builder company's culture. It also promotes more efficient and cost-effective operation within the factory homebuilding industry to incentivize integrating S+S within production while minimizing total costs and lead time. Overall, a new lean-centric strategy was established to manage and operate modular homebuilding and disseminate knowledge on lean pathways for integrating S+S into factory-built housing to home builders and the solar workforce.

Market Trends and Resiliency Benefit of FISS Homes

Through interviews and market research, the team identified several key value propositions for incorporating S+S into factory-built housing.

1. **Homeowner Resilience Benefits.** In many cases, if the first cost of the system is rolled into a mortgage, lower utility bills make it a cost-effective investment for the homeowner. The customer economic analysis did not include a value of the resilience benefit of backup power during outages. Insurers would generally be interested in opportunities to quantify the value of not losing power or restoring power quicker after severe disasters. Claims related to power outages could include food spoilage or damage from frozen pipes. Some insurers may consider homes still habitable even during power failures, but additional claims may arise for hotel stays while waiting for power and heat to return. Power continuity is important for reducing effects on the home, increasing habitability, and supporting claim reduction. Insurance companies, therefore, would likely be interested in learning how onsite energy production can drive down value of claims.
2. **Opportunities for Utility Companies.** There is potential value in deploying residential S+S for utility companies. Battery deployment can reduce peak demand, deferring or eliminating capacity investment; provide frequency regulation; and ease system integration of renewables.¹⁰ Having more utilities embrace S+S for the residential sector with incentives will be important to bring the solution to scale. More work should be done connecting factories to utility companies with existing programs, making them aware of incentives and standard

⁹ The HUD Offsite Construction Research Roadmap is at <https://www.huduser.gov/portal/pdredge/pdr-edge-trending-072622.html>.

¹⁰ For more information, see <https://www.mckinsey.com/industries/electric-power-and-natural-gas/our-insights/how-residential-energy-storage-could-help-support-the-power-grid>.

designs to island a home during outages. Vehicle-to-grid charging is another opportunity for utility companies to harness to provide power in post-disaster scenarios.

3. **Clean Energy Equity and Affordable Housing Applications.** Housing and energy advocates have a broad cross-sector interest in zero energy modular as a potential solution to the housing crisis, and FISS is a natural extension that would help support decarbonization and equity goals.
4. **Providing New Markets for Modular Factories.** Creating standardized, repeatable home designs with S+S that meet resiliency standards such as FORTIFIED and RELi could help support factories in demonstrating the high quality of the housing product and directly addressing misconceptions in the market. Because FORTIFIED requires third-party verification, it would be a selling point to potential customers and retailers. Modular housing lends well to incorporating resilient design features, such as roof deck sealing, protecting attachments, and paying attention to load paths, due to their protected environments and repeatable processes.

Key Markets for a FISS Solution

Locations with frequent power outages and a high risk of natural disasters are markets that would benefit from S+S. Modular factories conducting market research will want to consider resilient design elements to evaluate the appeal of these features to potential customers, while gaining insights into the needs for energy resilience in markets that they already serve.

Energy Resilience and Climate Risk

Although frameworks have been recently proposed, a metric that measures residential utility energy resilience has yet to be determined. The U.S. Energy Information Administration reports annual utility reliability data through metrics of interruption duration and frequency. The Customer Average Interruption Duration Index (CAIDI) takes the sum of all customer interruption durations divided by the total number of customer interruptions to determine the average restoration time for each utility. The National Risk Index that the Federal Emergency Management Agency (FEMA) developed incorporates natural hazards risk (measured as the annual expected loss of building value, population, or agricultural value), social vulnerability (measured by demographic characteristics to measure susceptibility of social groups to adverse effects of natural hazards), and community resilience (demographic characteristics as a measure of a community's ability to prepare for, adapt to, withstand, and recover from a disaster) to establish a baseline score for relative risk (FEMA, 2021). When the FEMA National Risk Index data are joined with CAIDI duration data from 2020, results reveal that a significant number of areas could benefit greatly from resilient power systems, as exhibit 1 shows.

Exhibit 1

Areas in 75th Percentile of CAIDI Outage Duration and National Risk Index Rating

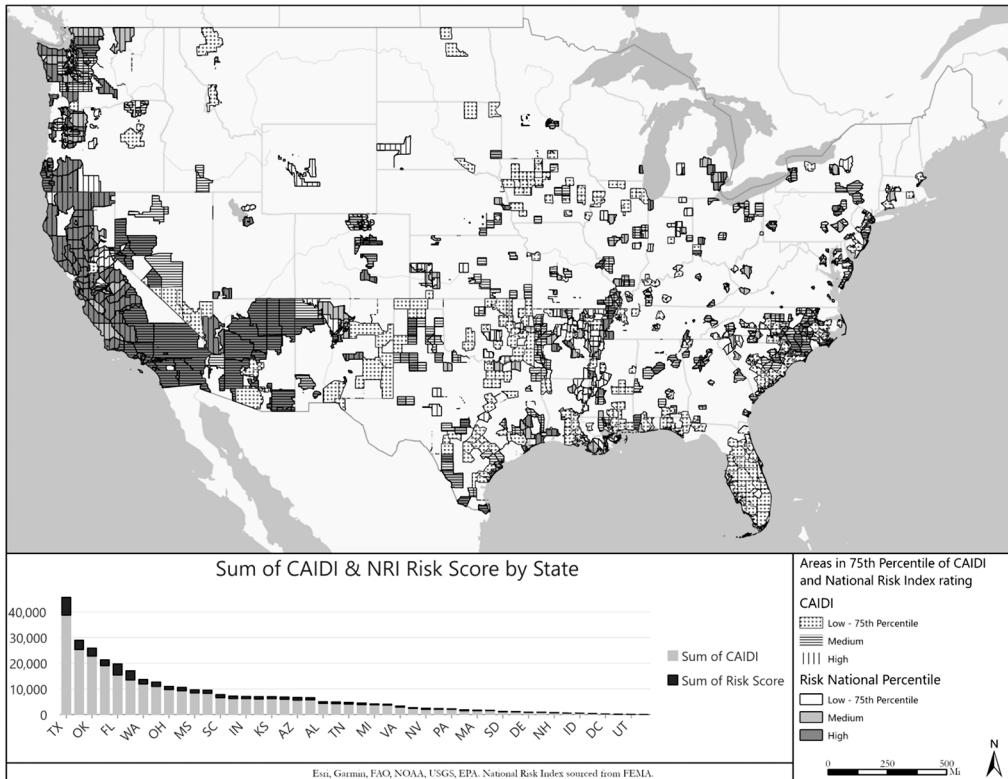

CAIDI = Customer Average Interruption Duration Index. NRI = National Risk Index.

Note: Graph shows combined totals of each metric by state.

Source: FEMA National Risk Index for National Hazards

Nearly every state in the continental United States has at least one county in the 75th percentile of risk and CAIDI outages. This number of outages is without the inclusion of major event days that are projected to increase as global temperatures rise. Areas that are at high risk in the National Risk Index and in outage duration are concentrated in coastal areas, mostly on the west coast and Pacific Northwest. These data indicate the need for energy power backup systems across the United States and potential for mitigating risk and supporting vulnerable populations through resilient design features.

Where Factory-Built Housing Needs To Scale

Even if current modular factories started incorporating S+S and other resilient design features into their products, gaps of service would be likely for the priority areas noted previously. Most residential modular factories are near the coasts; however, significant gaps are still in service territories. Although not a requirement for a modular home to be delivered in a day, costs may become prohibitively expensive as distance from factories increases. In addition, some factories may limit deliveries to locations within 100 miles (exhibit 2).

Exhibit 2

Driving Distance Between Modular Factories and Identified Priority Deployment Areas

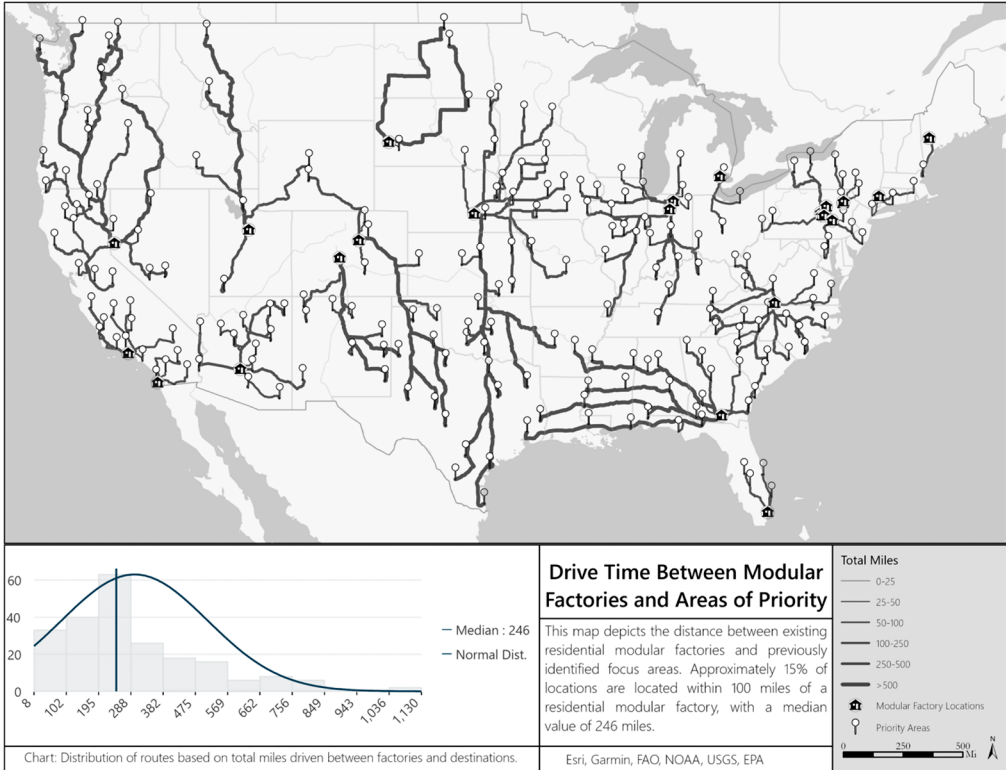

Source: Modular Building Institute

With this limitation, existing residential modular factories today could service less than 15 percent of identified priority areas. Notably, this limitation does not account for unrealistic delivery scenarios that geographic factors pose, such as deliveries crossing over mountain ranges. To bring FISS to scale, more factories will be needed, calling for a joint effort of investments from the housing, energy, and economic development sectors.

Economics of FISS Solution

Using the cost reduction results from the FISS Case Study section, the team evaluated single-family homeowner economics and duration of backup power in six locations in the United States. The locations were chosen to examine how different solar resources, electric consumption, and rates affect the financial results and performance during outages. The locations cover all regions and International Energy Conservation Code climate zones in the continental United States, and four of the five high-priority states called out in the Advanced Building Construction Collaborative *Market Opportunities and Challenges for Decarbonizing U.S. Buildings* report (Fisler et al., 2021). All the locations chosen are in the 75th percentile for outage risk, quantified with CAIDI scores and National Risk Index Risk Scores, as the Energy Resilience and Climate Risk sections discuss.

To estimate home energy consumption, the team used Open Studio’s Parametric Analysis Tool with Open Studio-HPXML measures to run Energy Plus simulations. The prototype home was modeled to an all-electric, high-performance specification in six different climate zones. Exhibit 3 shows the locations, climate zones, modeled electricity consumption, and modeled solar photovoltaic (PV) generation.

Exhibit 3

Locations Used for Customer Economic and Resiliency Analysis with Electric Consumption and Photovoltaic Generation Data

Location	IECC Climate Zone	Consumption (kWh)	PV Capacity (kWDC)	PV Generation (kWh)	PV Share of Use (%)
Houston, TX	2A	7,764	5.4	7,598	98
San Bernardino, CA	3B	7,172	4.3	6,357	89
Philadelphia, PA	4A	8,064	6.0	8,608	107
Bellevue, WA	4C	7,336	7.0	7,770	106
Wayne, MI	5A	9,320	7.3	9,887	106
Smallwood, NY	6A	8,695	7.0	9,713	112

IECC = International Energy Conservation Code. kWh = kilowatthour. kWdc = kilowatt direct current. PV = photovoltaic. Sources: Consumption—HPXML model and zero energy modular home; PV capacity—calculated for 100 percent of load; PV generation—National Renewable Energy Laboratory System Advisor Model; PV share of use—calculated by the authors

The team used the National Renewable Energy Laboratory’s (NREL) System Advisor Model (SAM) to size the batteries to meet the modeled energy use and to evaluate homeowner economics by running scenarios that tested the sensitivity of financing, first costs of S+S, effects of the climate zone on solar resources, electric consumption, and electric rates to understand the effect on financial results and performance during outages. Exhibit 4 shows the inputs to SAM.

Exhibit 4

Parametric Inputs

Input Variable	Values Used	
Installed cost (\$)	Average, average minus \$5,427, average minus \$10,126	
Location	Informed solar resource, consumption, electric rates	
Photovoltaic capacity (kW _{DC})	Varied by location 4.3 to 7.3	
Battery capacity	13.5 kWh _{AC} and 5 kWh _{AC}	
Critical load percent of total load	25%, 50%, 75%, 100% of total electric load	
Loan type	Personal Loan	Mortgage
Tax deductible interest	No	Yes
Loan term (years)	15	30
Loan rate (%)	5	3

kWh_{AC} = kilowatt alternate current. kW_{DC} = kilowatt direct current.

The analysis showed that the most significant driver of positive net present value (NPV) is long-term, low-interest financing through a mortgage. For homeowners, a positive NPV would be attained by rolling the first cost of FISS into a mortgage in California, Michigan, New York, Pennsylvania, and Texas. No cases of positive NPV were associated with 15-year personal loan

financing in any of the locations. Offsetting electricity with solar PV in states with high-cost electric rates increases NPV for the customer and provides a lower NPV for customers in states with low-cost electric rates. For example, in Washington, a state with low-cost electricity rates, homeowners would not have the benefit of positive NPV, even when rolling the first cost of the FISS into a mortgage. A final consideration is solar resources. Locations with higher solar resources and production can increase NPV even in states with lower utility costs, like Texas.

To evaluate how long the S+S system would support the electric loads during an outage, the team modeled a range of critical load percentages (exhibit 5). Under this scenario, the results show the probability of the battery being able to support the electric load for an outage at any time of year and time of day, as well as the mean hours the battery lasts across the simulated outages.

Exhibit 5

Resiliency Results from System Advisor Model Analysis: Likelihood of the Battery Lasting Through a 4-Day Outage and the Mean Hours of Autonomy for Four Scenarios of Regular Energy Consumption

State	IECC Climate Zone	Probability of Surviving 4-Day Grid Outage (by Percent of Load)				Mean Hours of Autonomy (by Percent of Load)			
		25%	50%	75%	100%	25%	50%	75%	100%
TX	2A	97%	76%	28%	5%	3,236	590	79	31
CA	3B	100%*	80%	33%	5%	8,760*	633	98	34
PA	4A	94%	69%	30%	10%	3,486	1,155	96	42
WA	4C	86%	59%	39%	13%	3,046	972	150	42
MI	5A	83%	57%	33%	14%	2,510	963	112	46
NY	6A	89%	64%	35%	13%	3,103	1,403	112	45

IECC = International Energy Conservation Code.

*SAM did not find an outage that the load would not be met when evaluated during a 14-year horizon.

Source: National Renewable Energy Laboratory SAM

The SAM analysis showed that in almost all cases, the S+S system could power 25 percent of the electricity needs in a home for 4 days, and under some scenarios, up to 100 percent of the load for 4 days.

FISS Case Study: KBS Builders’ Factory

A case study method was used to test the FISS approach, using data from the existing plan layout, material handling system, and operations of the project partner, KBS Builders, Inc. The team performed a comprehensive time study to help understand current productivity and identify opportunities to improve operations, reduce downtime at or in-between stations, and add new activities without undermining the current weekly productivity. The team used simulation modeling tools to replicate the flow of materials and discrete activities at and in-between stations (Podder et al., 2022). To study the current conditions in KBS Builders’ factory, the team followed a data collection strategy to include activity durations using a combination of expert interviews, manually documented time stamps from travelers, and data-collection methods using video data obtained from the factory. Key datasets included factory-built and onsite schedule, rough-in stage details, number of workers involved in each station, factory production rate (on

average), workforce composition (trades, labor, and other salary employees), factory photos and documentation of visual inspections, and information pertaining to spatial aspects of the construction progress. These datasets enabled the team to perform a comprehensive time study to help understand the existing conditions and identify early opportunities to improve weekly productivity, reduce downtime at or in-between stations and bays, and add new activities without undermining the current weekly productivity.

Onsite Solar + Storage Installation: Current Approach and Challenges

Most of onsite S+S installations are retrofits. In 2020, retrofitting accounted for 72.6 percent of all residential S+S systems installed (Grand View Research, 2021). Results of the study showed that retrofits are less efficient than when S+S is integrated into new construction, thus construction costs could be reduced (O’Shaughnessy et al., 2019). The team evaluated the onsite S+S installation approach via interviews from field professionals. Onsite S+S installation requires various trades and a solar subcontractor to coordinate material delivery and installation activities to each site. Typically, all equipment and materials are handled manually, thus reducing the efficiency of the installation and affecting the safety of workers. Ladders and ladder lifts are used to bring material on the roof and workers must wear safety harnesses. A need for solar-ready design houses exists (Labik et al., 2022). If the system is completely retrofitted, post-installation inspections are usually prolonged and can cause the inspectors to withhold the certificate of occupancy, due to the installations not meeting local code. Such issues lead to expensive onsite rework, decreases in efficiency, and prolonged lead time.

Offsite Solar + Storage Installation: FISS Approach

The offsite S+S installation moves most of the site work into the factory.

Baseline Process Simulation Model

KBS Builders’ weekly production target is eight modules; however, due to perceived bottlenecks and downtime, the factory has been able to achieve an average of five to seven modules. KBS Builders have expressed strong interest in identifying opportunities to consistently achieve at least eight modules per week, while adding the required activities related to S+S installation. In this study, the team chose the weekly production rate (that is, number of modules completed per work week) as the key performance indicator to evaluate different scenarios against the current market trend of onsite S+S installation. Based on the data collected from KBS Builders, the team created a baseline process simulation model in AnyLogic™ software. The baseline process simulation model acts as a digital twin of the real-world physical factory, because it accurately reflects the two-dimensional floor plan layout of the KBS Builders, the factory construction schedule, the workers and resources allocation in each station, the weekly productivity, and the work time in each station.

Estimated Solar + Storage Installation Time Data

Offsite integration occurs in a controlled factory environment. This setting ensures better coordination of standard installation procedures and resources in a controlled environment.

In the factory, installers can perform their work at a predetermined station suitable for activities related to S+S installation, including integration of small, distributed home batteries (see exhibit 6 for detailed installation time and resources needed).

Exhibit 6

Solar + Storage Related Activities with Installation Times

Activity with Location and Sequence	Production Type	Description	Number of Workers	Activity Time (in Hours)
Solar ready (Rough Electrical and Plumbing–Station #5)	Installation activity	1” PVC from mech room to roof	2	1
	Installation activity	1” PVC from mech room to electrical main	2	1
	Installation activity	2” PVC from mech room to electrical main (for battery)	2	4
	Installation activity	Conduit and wiring to belly or gable end	2	3.5
Preset solar roofing (Feeder Roofing Station–on the floor)	Installation activity	Solar deck installed on roof	1	2.2
	Installation activity	Solar feet installed on roof	2	2.3
	Installation activity	Solar rails installed on roof	3	
Solar roof set (Roof Set and Exterior Insulation–Station #7)	Roof set activity	Solar roof set on WIP module	NA	0.50 (same as typical roof set)
Post-set solar roofing (on top of the module)	Installation activity	Microinverters installed on roof	3	6.5
	Installation activity	Solar panels installed on roof	3	
Home battery install (Electrical Hookups–Station #14)	Installation activity	Battery in mech room	2	2.7
	Installation activity	Battery gateway	2	2.6
	Installation activity	Paneling for meters and disconnects on gable end	2	2

NA = not applicable. PVC = polyvinyl chloride. WIP = work in progress.

Comparison Analysis and Results

The team simulated an ideal FISS scenario within AnyLogic™, leveraging the baseline process model. The major learning outcome from exhibit 7 is that the new activities related to S+S installation can be added to the main production line without affecting the weekly production rate of eight modules per week. Such an ideal scenario is only possible after stations 5 through 12 undergo line balancing strategies that include reorganization of roof-related activities. See the Conclusions and Discussion sections for detailed results.

Exhibit 7

Total Time Taken To Complete Activities for One Module

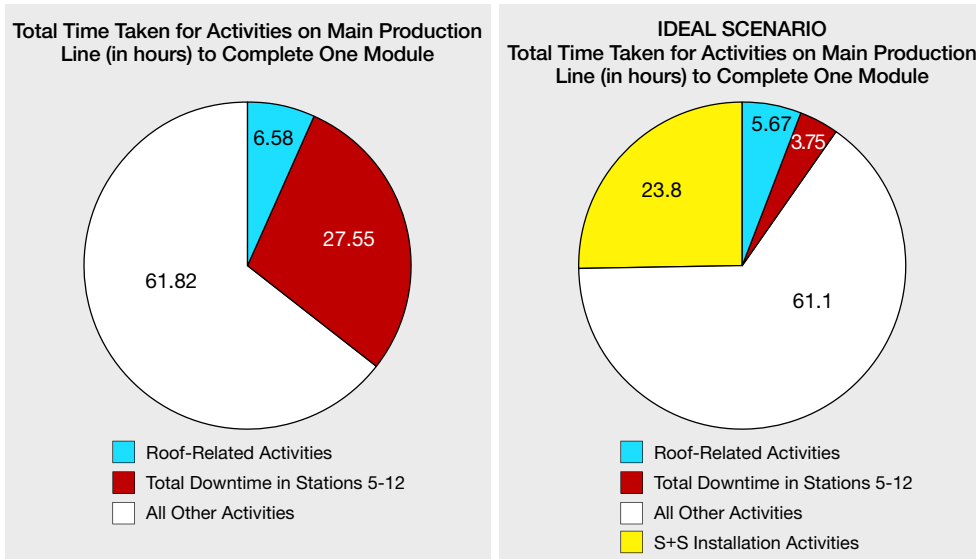

Note: the baseline is shown on the left, and the ideal scenario is shown on the right.

Cost Analysis of FISS

The team used the data from the solar vendors and installers interviews and NREL 2020 Solar + Storage Cost Benchmark to model the cost of the onsite installation approach (Feldman et al., 2020). The FISS cost was modeled using these costs and the simulation output.

Onsite Installation Cost Analysis

The cost analysis assumes a solar-ready home with 7.12 kW system and Tesla Powerwall 2 battery (13.5 kWh, 5kW rated output) installed on site. Contractors provided an onsite installation cost averaging about \$37,824, with the cost breakdown in exhibit 8.

Exhibit 8

Onsite Installation Cost Breakdown

Cost Component	Cost (\$)
Hardware	18,103
Permitting, inspection, and interconnection	825
Installation cost	18,896
Total cost	37,824

The team used NREL’s 2020 Solar + Storage Cost Benchmark, which breaks down the cost into \$/W_{DC} (dollar per Watt of direct current) to further break down the installation cost into each type of soft cost components (Feldman et al., 2020). In this analysis, the same 7.12 kW system was used. The specific assumptions and costs/W_{DC} are in exhibit 9.

Exhibit 9

Assumptions of Cost Model

Cost Component	Modeled Value	Description
Net profit	17%	Applied to hardware, installation labor, sales and marketing, design, PII
Sales and marketing (customer acquisition)	\$0.67 / Watt	Advertising, sales pitch, contract negotiation, customer interfacing
Engineering fee	\$100	Engineering design, professional engineer-stamped calculations, and drawings
PII	Given by contractors	Completion of applications, fees, design changes, field inspection
Overhead	\$0.28 / Watt	Rent; building, equipment, staff expenses
Installation labor	Calculated	Time study data
Installation labor burden	18%	Workers' compensations, federal and state unemployment insurance, FICA, builder's risk, public liability, applied to installation labor cost
Sales tax	5.1%	5.1% of cost of equipment
Supply chain cost	5%	5% of cost of equipment; Shipping, handling, inventory
Electrical BOS	\$0.28 / Watt	Conductors, switches, combiners and transition boxes, conduit, monitoring system, fuses, breakers
Structural BOS	\$0.08 / Watt	Flashing for roof penetrations, rails and mounting
Equipment	Given by contractors	

BOS = balance of system. PII = permitting, inspection, and interconnection.

The contractor gave the actual costs of the hardware and the permitting, inspection, and interconnection (PII). Other soft cost components were found by using the output of the ideal scenario (including S+S installation activities) model. Net profit paid to the contractor is modeled as a fixed margin of 17 percent that is applied to all hardware, labor, sales and marketing, design, and PII fees, resulting in \$4,699. Sales and marketing for the onsite approach were modeled as 0.67 \$/WDC, resulting in \$4,770 and accounting for advertising, sales pitch, contract negotiation, and customer acquisition. The installation labor was found to be \$2,492 with a labor burden of \$449. Once all soft costs were determined, the team validated the results with subject matter experts.

FISS Approach Cost Analysis

The team followed the same assumptions and approach, based on soft cost savings, to calculate factory installation cost for each system component. First, if the system is installed in the factory by using the existing workforce, the net profit paid to the contractor is removed, resulting in \$4,699 savings per system installed. Furthermore, sales and marketing costs of the S+S system are significantly reduced, mainly due to the system being advertised with the house, thus eliminating the need for extra marketing, contract negotiation, or extra customer acquisition. The sales and marketing cost, based on field professionals' interviews, was modeled as 0.15 \$/Wbc, resulting in

savings of \$3,702 per system installed. In the FISS approach, the overhead cost of the S+S system is built into the final house cost, which subject matter experts estimated results in a 30-percent reduction. Through the simulation, the team found the installation labor cost to be on average \$1,538 per system, with an installation burden of \$277, yielding savings of \$1,126 per installed system. The FISS approach resulted in a total savings of \$10,126 per installed system—about 26.77 percent potential cost reduction compared with onsite installation.

At this point, the manufacturer must decide how to allocate the savings realized through the FISS approach—either keep savings as profit or pass on the savings to the customer. The team chose to model three potential scenarios for the customer economics analysis: (1) Manufacturer keeps total savings as profit (for example, \$0 of the savings are passed on to the customer), similar to the current onsite approach; (2) Manufacturer keeps the factory installation savings and the rest of the savings, about \$5,427, are passed on to the customer; and (3) All the savings, about \$10,126, are passed on to the customer.

Exhibit 10 shows the S+S cost breakdown for all three scenarios.

Exhibit 10

Solar + Storage Cost Breakdown					
Cost Component	Onsite Approach	Factory Installation, Profits Kept		Factory Installation, Maximum Price Reduction	
	Cost (\$)	Cost (\$)	Savings (\$)	Cost (\$)	Savings (\$)
Net profit	\$4,699	\$4,699	\$0	\$0	\$4,699
Sales and marketing (customer acquisition)	\$4,770	\$1,068	\$3,702	\$1,068	\$3,702
Engineering fee	\$100	\$100	\$0	\$100	\$0
Permitting, inspection, interconnection	\$825	\$825	\$0	\$825	\$0
Overhead	\$1,994	\$1,396	\$598	\$1,396	\$598
Installation labor	\$2,492	\$1,538	\$954	\$1,538	\$954
Installation labor burden	\$449	\$277	\$172	\$277	\$172
Sales tax (of cost of equipment)	\$923	\$923	\$0	\$923	\$0
Supply chain costs (of cost of equipment)	\$905	\$905	\$0	\$905	\$0
Electrical BOS	\$1,994	\$1,994	\$0	\$1,994	\$0
Structural BOS	\$570	\$570	\$0	\$570	\$0
Hardware	\$18,103	\$18,103	\$0	\$18,103	\$0
Total savings			\$5,427		\$10,126
Total cost (system installed)	\$37,824	\$32,397		\$27,698	

BOS = balance of system.

Conclusions

The FISS approach resulted in a total savings of about 26.77-percent potential cost reduction compared with onsite installation. In addition, implementing the ideal scenario would mean completing eight modules per week with integrated S+S. Solar ready activities, post-set solar roofing activities, and home battery installation activities use 86.39 percent of the observed downtime in stations 5 through 12, where the remaining downtime can be available for idle time or buffer time by design. Furthermore, the main production line is balanced and can continuously achieve the weekly production target of eight modules per week. Introducing innovation into homebuilding results in a different set of challenges to management, the following list identifies these challenges and potential solutions that managers responsible for implementing new technology must surmount practical guidelines for factories to design and construct affordable S+S homes. The recommendations in exhibit 11 help to ensure the efficient and effective integration of S+S installation.

Exhibit 11

Recommendations (1 of 2)

Houses Should Be Solar-Ready Designed Early in the Design Phase

- **Product Design.** Using lean product design can eliminate waste in production before it happens.
- **Net Zero Emission (NZE) Goals.** For companies to achieve aggressive NZE goals, clear direction from the client must be given, and teams must fully embrace the directive.

Production Line Needs To Be Tailored for Solar + Storage Installations

- **Balance of Systems.** New activities related to solar + storage installation can be integrated into the main production line without affecting the weekly production rate after downstream stations undergo line balancing strategies, leading to 100 percent utilization.
- **Reorganization of Roofing Activities**
 - Reorganizing relevant roofing activities to the feeder stations that run parallel will reduce travel distance and time.
 - Moving the solar roofing activities to the floor closer to the roof build as an extension of the feeder station can reduce the total time for related activities by 50 percent and mitigate existing bottlenecks.
 - Prerroof set activities: Mounting and solar decking activities can be moved to the floor, immediately after solar roofing.
 - Post-roof set activities: Solar photovoltaic install activities can occur after the roof is set; activities can be moved upstream, on the floor, closer to roof build station.
 - Home battery installation activities: Small, decentralized home battery can be installed after the interior paint activities.
- **Minimizing Excess Processing Time.** Solar-ready activities can be performed along with electrical roughing, and workstations with similar activities can be combined, allowing for workers and resources to move between the stations.

Workforce Strategy Needs To Be Developed

- **Workforce Strategy.** To reach production objectives more quickly and efficiently, facilities must adopt a lean-centric workforce strategy. This strategy could include multiskilling existing workers, hiring a new department focusing only on solar + storage related activities, or using a subcontractor to install the system.
- **Maintain Skilled Workforce.** Identify opportunities to upskill existing workforce and understand trade-offs for involving solar + storage subcontractors in performing the new activities.

Exhibit 11

Recommendations (2 of 2)

Quality Control Inspection Must Be Tailored for Solar + Storage Installation

- **Quality Control.** Developing a comprehensive quality control strategy for each solar + storage related station to audit the work eliminating waste and reduce costs caused by defects.

Supply Chain, Long-Term Storage, and Staging Areas Need To Be Established

- **Supply Chain.** Procure solar + storage components and systems from a regional supply chain.
- **Storage and Staging Area.** Expand current factory floor to add a storage area for solar + storage components and systems.
 - Benefits of adding long-term storage and staging areas include limiting travel distance and material handling and decreasing the probability of damage to materials due to handling and exposure.

Multiple stakeholders benefit from the design solution that FISS provides in exhibit 12.

Exhibit 12

FISS Design Solution

For Homebuilders

- Provides additional benefits for customers that are marketable, including quality, safety, resiliency, energy efficiency.

For Homeowners

- Provides resilience, comfort, safety, potential financial benefits.

For Policymakers

- Product can be mass-produced, support disaster recovery, support sheltering in place, continuity in vulnerable populations.

For Utilities

- Product can create grid-interactive homes that are able to participate in utility programs and support grid functions.

As this analysis notes throughout, despite barriers, a growing interest is in scaling S+S as a resiliency solution and scaling modular housing to address industry needs and gaps. Great potential exists to scale modular housing in the United States to support resiliency and efficiency. Driving adoption of FISS in the residential new construction market is not simple. The new construction industry is chronically fragmented with many players across design, construction, supply, and demand. The industry is largely the same as it was 100 years ago—same business models and profit margins that require risk aversion. Increasing the deployment of S+S will require a combination of technology innovation, workforce training, demand aggregation and supply development, and a cross-sector approach. The following recommendations focus on what could help further scale this solution to reach one million customers during the next 10 years.

- Mortgages that meet payment schedules of modular.
- Appraisals that recognize value of S+S.
- Existing and new factories willing to build to a zero-energy standard and offer FISS as a product.
- Utility companies that will support S+S.
- Homeowners that understand value proposition.
- Standardization of building code.

Acknowledgments

The financial support that HUD provided for this research under grant number H-21690 CA is gratefully acknowledged. Further, the authors thank Mike Blanford for managing and coordinating this work on HUD's behalf. Finally, the authors thank the editors and two referees for their helpful comments.

Authors

Isabelina Nahmens is a professor in the Department of Mechanical and Industrial Engineering at Louisiana State University (LSU). Ondřej Labík is an industrial engineering graduate student at LSU. Alison Donovan is a managing consultant at VIEC, and her team includes Kalee Whitehouse, Damon Lane, Desmond Kirwan, and Leslie Badger. Ankur Podder and Shanti Pless are research engineers at National Renewable Energy Laboratory.

References

Bertram, Nick, Steffen Fuchs, Jan Mischke, Robert Palter, Gernot Strube, and Jonathan Woetzel. 2019. *Modular Construction: From Projects to Products*. McKinsey and Company, Capital Projects and Infrastructure.

Federal Emergency Management Agency (FEMA). 2021. "National Risk Index for Natural Hazards." <https://www.fema.gov/flood-maps/products-tools/national-risk-index>.

Feldman, David, Vignesh Ramasamy, Ran Fu, Ashwin Ramdas, Jal Desai, and Robert Margolis. 2020. *U.S. Solar Photovoltaic System and Energy Storage Cost Benchmark: Q1 2020*. National Renewable Energy Laboratory.

Fisler, Diana, Roberto Interiano, Liam Keyek, Conor Larkin, Maura Mooney, Aven Satre-Meloy, and Lucas Toffoli. 2021. *Market Opportunities and Challenges for Decarbonizing U.S. Buildings: An Assessment of Possibilities and Barriers for Transforming the National Buildings Sector with Advanced Building Construction*. Advanced Building Construction Collaborative.

Grand View Research. 2021. *U.S. Residential Solar PV Market Size, Share and Trends Analysis Report by Construction, by State (California, New York, Arizona, New Jersey, Massachusetts, Texas, Rest of the U.S.), and Segment Forecasts, 2021–2028*. San Francisco: Grand View Research.

Green Mountain Power. 2018. “GMP Customers Keep Lights on with Stored Low Carbon Energy During Storm Outages.” News release. Colchester, VT: Green Mountain Power. <https://greenmountainpower.com/news/gmp-customers-keep-lights-onwith-stored-low-carbon-energy-during-storm-outages/>.

Home Innovation Research Labs. 2019. “Home Innovation Awarded HUD Contract to Create Residential Resilience Guidelines for Builders and Developers.” News release. Upper Marlboro, MD: Home Innovation Research Labs. https://www.homeinnovation.com/about/news_and_events/home_innovation_news/2019_1011_hi_awarded_hud_contract_for_resilience_guidelines.

Labík, Ondřej, Isabelina Nahmens, Laura Ikuma, and Craig Harvey. 2022. “Barriers of Integration Solar + Storage Upstream in Modular Construction.” Presented at Institute of Industrial and Systems Engineers Annual Conference and Expo, Atlanta, GA, May 21–24.

O’Shaughnessy, Eric, Gregory F. Nemet, Jacquelyn Pless, and Robert Margolis. 2019. “Addressing the Soft Cost Challenge in U.S. Small-Scale Solar PV System Pricing,” *Energy Policy* 134.

Podder, Ankur, Shanti Pless, Isabelina Nahmens, Ondřej Labík, and Alison Donovan. 2022. “How Can Construction Process Simulation Modeling Aid the Integration of Lean Principles in the Factory-Built Housing Industry?” *Cityscape* 24 (1): 331–343.

3D Concrete Printed Houses: Barriers to Adoption and Construction Practices

John B. Peavey

Ed Hudson

Zachary A. Summy

Jon Violette

Home Innovation Research Labs

Abstract

Home Innovation Research Labs (Home Innovation) was tasked by the U.S. Department of Housing and Urban Development (HUD) to explore the integration of 3D concrete printing (3DCP) technology in residential buildings. Most research in this area has focused on standardizing the equipment design, manufacturing process, and material formulation, which is critical to developing design techniques and performance criteria within the building code (Buswell et al., in press). To complement the current 3DCP research, this project investigates two key critical construction issues: (1) identify barriers to the adoption of 3DCP technology (such as the lack of building codes or standards, the lack of design and construction guidance, and the lack of technical expertise to implement the new technology) and (2) system integration—evaluate how 3DCP components (primarily walls) will be installed with conventional building product components. Home Innovation is conducting qualitative research among home builders and contractors to understand the challenges and opportunities to accelerate the adoption of 3DCP technology. In addition, Home Innovation has evaluated the construction of 3DCP residential buildings in the field with close attention to (1) installation of windows and doors, (2) wall penetration methods for installing utilities (primarily plumbing and electrical), (3) wall connections between the roof and foundation, and (4) interior and exterior wall finishing options. The project is in process, and the data presented in this article are preliminary.

Introduction: The Evolution of 3DCP Technology

3D concrete printing (3DCP) technology offers new opportunities for innovation in the building industry. Since concrete is the most widely used building material in the world, 3DCP technology has the potential to significantly change how buildings are delivered using new construction

techniques (GCCA, 2020). With this technology, the concrete is formulated to achieve greater workability, setting, hardening time, and mechanical properties, which can be optimized for the specific requirements of the building. These attributes make innovative structural design possible using a 3D printer that extrudes concrete material layer by layer without any formwork support, as shown in exhibit 1 (ICON – 3D Tech, 2020).

Exhibit 1

PERI – Multifamily Building in Houston, Texas



*Note: 3D Printed Wall by PERI.
Source: Home Innovation Research Labs*

Several buildings around the world have been successfully erected using 3DCP technology in a wide range of applications—from affordable housing to structures for military applications.

3DCP technology was developed and first introduced in the late 1980s. The earliest applications were to manufacture solid objects using robots that deposited “stone-like materials” without formwork. Over the years, a variety of deposition strategies, robots, printer heads, and material formulations have been used.

Major developments in 3DCP technology started in California when Behrokh Khoshnevis introduced the “contour crafting” technique, which is the method of layering concrete extrudate through fused deposition modeling (FDM), which generally describes how the material is fused

through heat and nozzle design (Khoshnevis, 2004; Khoshnevis and Dutton, 1998; Khoshnevis et al., 2006, 2001). The contour crafting technique is one example of FDM and involves layers of continuous concrete-like filament being deposited on top of each other using a single robot. With a few notable exceptions, most 3DCP devices around the globe operate using the FDM principle. In 2014, as an alternative to working with a single, large robot, the Institute of Advanced Architecture of Catalonia (IAAC) grouped together several small robots with sensing (or “swarm”) technology to build a concrete printed structure (IAAC, 2014).

A more traditional, stereolithography 3D printing technology, named D-Shape, was adapted for concrete-like construction by Enrico Dini (Colla and Dini, 2013). Allouzi, Al-Azhari, and Allouzi (2020) built on the D-Shape concept using a binder-jetting procedure in which a powder deposition is hardened using a binder instead of being extruded like the FDM filament. Each layer of material is deposited in the required thickness and compacted; then, the printer deposits the binder where the material needs to be solid. Once the printing is completed, loose powder is cleaned from the finished component. In 2014, Universe Architecture and contractor Royal BAM Group used the D-Shape technique to develop the Landscape House in Amsterdam, the Netherlands (Adlughmin, 2014). This project was part of a competition; the technique was not broadly adopted like the FDM filament technique.

Disadvantages of Traditional Concrete Construction

Traditional concrete is made of cement, sand, aggregate, and water, which are combined to form a slurry that has no form of its own when wet. As a result, it has to cure (harden) in a formwork mold. Traditional formwork is fabricated using timber, but it can also be constructed from steel, glass fiber reinforced plastics, and other materials.

Nematollahi, Xia, and Sanjayan (2017) highlighted formwork as a significant source of waste in concrete construction. On average, formwork is used five times before being discarded into a landfill, which contributes to a growing amount of waste in the construction industry. Llatas (2011) estimated that 80 percent of the world’s waste is generated by the construction industry. In addition to waste concerns with formwork, approximately one-half the total cost of traditional concrete construction is related to the labor-intensive and time-consuming installation and deconstruction of formwork.

Beyond the issue of waste, there are worker safety concerns related to traditional concrete construction. The Occupational Safety and Health Administration (OSHA) of the U.S. Department of Labor lists the following potential hazards for workers in the concrete industry: (1) eye, skin, and respiratory tract irritation from exposure to cement dust; (2) inadequate safety guards on equipment; (3) inadequate lockout/tagout systems on machinery; (4) overexertion and awkward postures; (5) slips, trips, and falls; and (6) chemical burns from wet concrete (OSHA, 2004). Bos et al. (2016) also analyzed the physical labor involved during traditional concrete manufacturing, noting that the erection of molds and the placement of steel reinforcement is physically demanding labor, particularly when custom-made geometries are required.

3D Concrete Printing Techniques and Equipment

Nematollahi, Xia, and Sanjayan (2017) explored the two major techniques used in 3DCP technologies: extrusion-based and powder-based. They stated that the extrusion-based technique, analogous to the FDM method, extrudes cementitious material from a nozzle mounted on a gantry, crane, and/or robotic arm to print a structure layer by layer. This technique has been specified mostly for onsite construction applications, such as large-scale building components with complex geometries, and it has the potential to make a significant and positive contribution to the construction industry by saving time and eliminating the need for formwork. They explain that the powder-based technique creates accurate structures with complex geometries by depositing binder liquid (“ink”) selectively into a powder bed to bind powder where it impacts the bed. This technique is an offsite process designed for manufacturing precast components. The authors suggest the powder-based technique is highly suitable for small-scale building components, such as partition walls or panels, and interior structures such as benches or furniture that can then be assembled or installed on site.

Materials Used in 3D Concrete Printing

3DCP material formulations differ compositionally from traditional concrete by adding three ingredients to the basic concrete formulation: (1) a reinforcing material; (2) an adhesive; and (3) a hydrator. This formulation gives 3D concrete special attributes, including the ability to maintain its shape when wet, eliminating the need for formwork.

Allouzi, Al-Azhari, and Allouzi (2020) explored the composition of cement used in both traditional concrete construction and 3DCP. The authors noted that traditional types of concrete formulations are not suitable for 3D printing because the aggregate of materials jams and damages the printing nozzle. Most current research studies are focused on developing new concrete material formulations for 3D printing to obtain the appropriate material performance properties and extrudability that enables the material to be printed continuously and stacked in layers.

One developing printing technology that uses the new mortars is called Shotcrete 3D Printing (SC3DP) by Raatz et al. (2019). The SC3DP technology is significantly more complex than the conventional 3D concrete printing processes because several closed-loop online control routines are required to drive the robotics.

The Ting et al. study (2019) considered the use of recycled glass as the fine aggregate for 3DCP applications. While the mechanical strength of concrete with sand aggregates was better than the concrete formulations using recycled glass, the concrete with the recycled glass was more flowable in 3DCP technology than the concrete with sand aggregates. Further study has been recommended to develop a mix of sand and recycled glass aggregate that will result in the optimum mechanical and flowability properties for new 3DCP mortars.

Hambach and Volkmer (2017) evaluated fiber-reinforced mortars to determine their flexural and compressive strength. Fibers will align with the flow direction of the 3DCP process, which makes

some control of fiber orientation possible within the printed structures. The fiber alignment can be used to tailor the material properties of 3DCP components.

In 2018, the American Concrete Institute (ACI) established Committee 564 on 3D Printing with Cementitious Materials.¹ The mission of the committee is to develop and report information on three-dimensional printing (3-D) printing, or additive manufacturing with inorganic cementitious materials. The work is conducted through three subcommittees that are focused on (1) reporting on technical developments in the area of 3DCP, (2) developing guidance documents for structural design and testing, and (3) developing guidance documents for material formulation and testing.

Concurrent with the work of ACI, the National Institute of Standards and Technology (NIST) established a program focused on the premise that “Additive Manufacturing (AM) with concrete, also known as 3-D concrete printing (3DCP), is an emerging technology in the construction industry.”² In this program, NIST addresses the need for basic standardization of the material and technology.

Today, research continues in the area of material development. In June 2022, Texas A&M University announced a new research project to develop hempcrete for 3DCP technology. The research, led by Dr. Petro Sideris, is novel because “using hempcrete has the potential to lower the environmental impact of traditional construction methods and make housing more affordable and available” (Chapman, 2022).

Adoption of 3DCP Technology for Residential Construction

HUD has studied the diffusion of innovation in the residential building industry for decades. The process of accepting and adopting new technology is generally slow, and “no single path exists for housing industry adoption of new technologies” (Koebel et al., 2004). Furthermore, Koebel et al. (2004) stated that “acceptance of new technologies and materials ultimately depends on whether they meet the needs of the consumer and the builder better than existing technologies and materials. The needs for high- and low-end markets, or for large and small builders, are not always the same. Additionally, geographic differences also help shape the needs of both builder and buyer.”

Some generalizations, however, have emerged from this review of diffusion trends from 1995 to 2001 that warrant further research. Further quoting Koebel et al. (2004): “Large builders seem to be first to adopt new materials that offer a cost savings, improvement in production process, reduction in call-backs or exposure to liability. Smaller builders are often first to adopt technologies where high consumer awareness of a material exists, the price of the new technology is significantly higher than what it replaces, or if the home construction process must be substantially altered. Homes in geographic areas where homebuyers and builders have an increased awareness of a new technology or find a technology most useful are likely to be first to adopt.”

¹ For more information, see ACI’s Committee 564: 3D Printing with Cementitious Materials at: https://www.concrete.org/committees/directoryofcommittees/acommitteehome.aspx?Committee_Code=C005640B.

² NIST. “Additive Manufacturing with Cement-based Materials.” [https://www.nist.gov/programs-projects/additive-manufacturing-cement-based-materials#:~:text=Additive%20Manufacturing%20\(AM\)%20with%20concrete,used%20to%20create%20infrastructure%20components](https://www.nist.gov/programs-projects/additive-manufacturing-cement-based-materials#:~:text=Additive%20Manufacturing%20(AM)%20with%20concrete,used%20to%20create%20infrastructure%20components).

Market Research Findings

Home Innovation identified construction industry stakeholders, including builders, contractors (such as plumbers and electricians), architects, developers, and homeowners to understand the barriers to adoption and the opportunities for 3DCP technology to become commonplace within the construction industry. Since 3DCP technology is highly automated, it can be a solution for those areas of the country where there is a permanent labor shortage for construction. Since the technology can be used to quickly build a single-story small home (i.e., 350 to 500 square feet), it may become a perfect option for the tiny home enthusiast, and it may also be a cost-effective option for those living in poverty, as demonstrated by the first 3DCP housing community built in Mexico (Young and McMahon, 2020).

Home Innovation observed qualified construction professionals at the jobsite in Austin, Texas, and documented how 3DCP changes the design and construction process. Home Innovation is currently conducting a national survey to validate the market need for 3DCP and to understand the construction process barriers that currently exist to widespread commercialization of 3DCP technology.

Methodology

Home Innovation conducted a two-phase primary qualitative market research study in 2021 to better understand builder, architect, and trade perspectives of construction considerations when using 3D concrete printing (3DCP) technology. The objectives of the primary qualitative market research were to: (1) understand construction considerations from the perspectives of the builders, architects, plumbers, and electricians; (2) better understand considerations, potential benefits, and potential challenges of 3DCP construction in comparison to traditional construction methods; and (3) identify opportunities and challenges that may influence the adoption of 3DCP in residential construction.

Phase 1: Home Innovation partnered with one 3DCP company for the primary market research, which consisted of nine onsite interviews in Austin, Texas, with builders, general contractors, architects, plumbers, and electricians at homes under construction that incorporated 3DCP technology to print the first story of the homes. Each interview lasted approximately 60 minutes. The interviews were conducted from April 20–22, 2021, after the walls had been printed, but still during the rough-in stage of construction. The four homes were designed by an architect and were either already under contract or on the market for sale.

Exhibit 2

Example of an Onsite Individual In-Depth Interview Location in Austin, Texas



Note: 3D Printed House by ICON.

Source: Home Innovation Research Labs

Phase 2: This phase consisted of nine videoconference interviews with a geographic mix of builders, plumbers, and electricians. The stimuli for those interviews included a slightly revised 3DCP technology overview description from what was presented in Austin, Texas, including photographs of the homes under construction and additional photos of homes completed using 3DCP technology in a community built to house the homeless in Mexico. The interviews were designed to build on learning from the in-person interviews conducted during Phase 1.

The goal, purpose, and intent of the qualitative research were to understand builder, architect, and trade perspectives and to identify key questions, considerations, and potential challenges, not to evaluate a specific 3DCP technology.

3DCP Technology

Overall, the 3DCP technology is considered to offer multiple benefits to construction as summarized in exhibit 3.

Exhibit 3

Perceived Benefits of 3DCP Technology

Speed of construction

Cost of construction (less labor)

Elimination of finishing materials (exterior and interior)

Strength of the “double” layer wall (improved resiliency)

Fire resistance

No formwork needed (less cost)

Able to build curved or irregular floorplans (which are difficult to do now)

3DCP = 3D Concrete Printing.

Source: Home Innovation Research Labs

Builders wanted to understand how the wall performed with respect to meeting energy code requirements, which is an important consideration, as shown in exhibit 4.

Exhibit 4

Questions from Builders About 3DCP Exterior Wall Thermal Performance

What is the R-Value of a 3DCP exterior wall without insulation?

How can insulation be integrated into a 3DCP exterior wall?

How can R-25 or greater insulation be achieved in 3DCP exterior walls?

How difficult is it to air-seal a 3DCP exterior wall? Can a tight building envelope be achieved?

Can an air gap within the wall cavity improve the R-Value of the 3DCP exterior wall?

Will thermal bridging occur even if spray foam is used inside the 3DCP exterior wall?

Can continuous insulation be integrated into 3DCP exterior wall?

3DCP = 3D Concrete Printing.

Source: Home Innovation Research Labs

Builders wanted to understand how moisture management would be addressed, especially in hot, humid climates. They wanted to know the perm ratings of the concrete material and understand more about the vapor transmission and potential for water penetration. There was some concern about not using a moisture barrier; more information is needed about how the wall design protects against moisture and potential mold growth. Since the windows at the residential house in Texas were installed without a weather-resistant barrier (WRB) or flashing, water penetration was a concern for the participants in the market research study, as shown in exhibit 5.

Exhibit 5

Questions from Builders About 3DCP Exterior Wall Moisture Management

How are windows and doors sealed to prevent water infiltration?

How are walls treated to prevent water penetration (i.e., damp proofing or water proofing)?

Is the bond agent between layers enough to prevent water penetration or water infiltration?

How difficult is it to air-seal a 3DCP exterior wall? Can a tight building envelope be achieved?

3DCP = 3D Concrete Printing.

Source: Home Innovation Research Labs

Builders thought the foundation and roof connections were well designed because there was a threaded anchor extending from the foundation, through the walls, and then connecting to the top plate. Nonetheless, additional guidance was requested, as shown in exhibit 6.

Exhibit 6

Questions from Builders About 3DCP Foundation and Roof Connections

What design options are available when connecting the foundation to the wall?

What design options are available when connecting the roof to the wall?

What are the structural considerations when building a 2-story structure?

What are the structural considerations when considering soil type and potential settling issues?

3DCP = 3D Concrete Printing.

Source: Home Innovation Research Labs

Builders wanted more information about how to install windows and doors, including if standard installation instructions would be developed for 3DCP walls (exhibit 7).

Exhibit 7

Comments and Questions from Builders About 3DCP Window and Door Installation

Flashing and sealing details are needed for both windows and doors.

Will windows and doors be developed by manufacturers specifically for 3DCP walls?

Can any best practices be adopted from similar masonry walls for 3DCP walls?

How should cracks between windows, doors, and 3DCP walls be sealed if walls are not straight?

Aesthetically, how should window and door trim be installed on 3DCP walls?

How should windows and doors be replaced in 3DCP walls?

How should the 3DCP walls be supported above the windows and doors (can this be standardized)?

Will air and water infiltration be an issue for curved edges when installing straight windows and doors?

How can ADA compliant doors be installed if doorways are not printed wide enough?

3DCP = 3D Concrete Printing, ADA = Americans with Disabilities Act.

Source: Home Innovation Research Labs

Builders and electricians wanted more information about how to install electrical conduit and receptacles, including if standard installation instructions would be developed for 3DCP walls (exhibit 8).

Exhibit 8

Comments and Questions from Builders and Electricians About 3DCP Electrical Installation

Electricians did not believe there would be any savings in terms of labor or time.

Builders believed there would be some marginal time savings during installation of electrical.

Builders believed that electrical conduit and receptacles should be installed just like CMU walls.

Does the installation of electrical conduit or receptacles save labor or time?

Electricians insisted that they should be on site when electrical is installed in 3DCP walls.

Will the building code allow a non-electrician to install electrical conduit and receptacles?

The electrical inspection protocol will likely differ from traditional construction.

3DCP = 3D Concrete Printing, CMU = Concrete Masonry Unit.

Source: Home Innovation Research Labs

Builders and plumbers wanted more information about how to install piping and plumbing fixtures, including if standard installation instructions would be developed for 3DCP walls (exhibit 9).

Exhibit 9

Comments and Questions from Builders and Plumbers About 3DCP Plumbing Installation

Plumbers believed that the labor and time required would be like CMU walls.

Plumbers believed that planning and layout would be critical since it will be hard to relocate pipe.

Builders and plumbers believed that pipe chases on the interior or exterior wall would be needed.

Pipe vents would need to be located during the planning period.

Will 3DCP manufacturers provide some general guidance for plumbing installation?

3DCP = 3D Concrete Printing. CMU = Concrete Masonry Unit.

Source: Home Innovation Research Labs

Builders wanted more information about finishing options for the interior and exterior walls, including if standard installation instructions would be developed for 3DCP walls (exhibit 10).

Exhibit 10

Comments and Questions from Builders About Finishing Exterior and Interior Walls

What are the finishing options for exterior and interior walls?

Will customers like the appearance of the 3DCP wall?

Eliminating the cost of drywall and exterior cladding is significant cost and time of construction savings.

What paint can be used on the interior and exterior 3DCP Walls?

Without drywall in the interior of the house, how would one hang objects on the wall (masonry screws)?

Cracks in concrete was considered a major issue for 3DCP Walls. How can this be minimized?

Builders believed that surface textures and finishes should be offered.

3DCP = 3D Concrete Printing.

Source: Home Innovation Research Labs

Builders had additional comments and questions for 3DCP technology manufacturers concerning barriers to the adoption of the 3DCP walls (exhibit 11).

Exhibit 11

Questions from Builders for 3DCP Manufacturers

Does the 3DCP concrete material "breathe"? Is it permeable?

How much space does the 3D concrete printer require on the jobsite?

Will it be a challenge to use the technology on small lots?

Are there weather limitations to running the 3D concrete printer (i.e., rain or temperature)?

What is the typical cure time for 3DCP walls?

How should 3DCP walls be cleaned (if they do not have a finish)?

Is the material recyclable?

How can one do alterations or modifications to the floor plan in the future?

3DCP = 3D Concrete Printing.

Source: Home Innovation Research Labs

Integrating 3DCP Technology into Traditional Construction

3DCP technology manufacturers have worked with the International Code Council Evaluation Services (ICC-ES) to develop new acceptance criteria (AC509) for evaluating 3D automated construction technology for 3D concrete (Ekenel and Sanchez, 2019). Acceptance criteria define the performance of new building materials, products, and technology. The criteria are precursors to formally defining new construction technologies and building products for inclusion in the building code. Manufacturers that produce 3DCP products in accordance with AC509 will have to demonstrate consistent product performance using a quality-controlled process. This is a very important step when ensuring the safety of any building product and defining expected performance (including the mode of failure). This step can take many years because when a technology is new to the industry, “know-how” can be proprietary and a competitive edge, which often makes codifying standard construction practices difficult. The primer document will highlight findings from the market research study along with other instructional guidance, which is considered a vital first step in the adoption of 3DCP technology. Both the 3DCP industry and home builders interested in the technology will benefit from this educational information.

Conclusion

Home Innovation has convened an advisory group of key stakeholders to review the technical findings and discuss ways to expedite the widespread adoption of 3DCP technology. The study indicates 3DCP technology is expected to significantly change the homebuilding process in terms of labor requirements (different skill sets and fewer people), aesthetic wall exterior (how to install conventional cladding products if they are preferred), the construction process itself (no more 2 x 4 framing for the walls), and how best to demonstrate code-compliance when the technology is not yet recognized by the building code, to name a few. Since the construction industry is often slow to adopt new technology, there will need to be education and instruction about how best to integrate 3DCP technology with builders that are used to building the conventional way.

Acknowledgments

The financial support provided by HUD for this research under grant number H-21690 CA is gratefully acknowledged. Further, the authors thank Mike Blanford for managing and coordinating this work on HUD's behalf. Finally, the authors thank the editors and two referees for their helpful comments.

Authors

John B. Peavey, PE, is the director of building science at Home Innovation Research Labs. Ed Hudson, MBA, is the director of market research at Home Innovation Research Labs. Zach Summy is an analyst and project manager at Home Innovation Research Labs. Jon Violette is the marketing research manager at Home Innovation Research Labs.

References

- Adlughmin. 2014. "D-Shape Looks to 3D Print Bridges, a Military Bunker, and Concrete/Metal Mixture." 3DPrint.com. 3DR Holdings. <https://3dprint.com/27229/d-shape-3d-printed-military/>.
- Allouzi, Rawan, Wael Al-Azhari, and Rabab Allouzi. 2020. "Conventional Construction and 3D Printing: A Comparison Study on Material Cost in Jordan," *Journal of Engineering* 2020.
- Bos, Freek, Rob Wolfs, Zeeshan Ahmed, and Theo Salet. 2016. "Additive Manufacturing of Concrete in Construction: Potentials and Challenges of 3D Concrete Printing," *Virtual and Physical Prototyping* 11 (3): 209–225.
- Buswell, R. A., W. R. Leal de Silva, S. Z. Jones, and J. Dirrenberger. In press. "3D Printing Using Concrete Extrusion: A Roadmap for Research," *Cement and Concrete Research*. https://tsapps.nist.gov/publication/get_pdf.cfm?pub_id=924709.
- Chapman, Alyson. 2022. "Texas A&M Receives \$3.74M for Green, 3D-Printed Hempcrete Buildings Research." News release. Texas A&M University Engineering. <https://engineering.tamu.edu/news/2022/06/cven-texas-am-receives-374m-for-green-3d-printed-hempcrete-buildings-research.html>.
- Colla, V., and E. Dini. 2013. "Large Scale 3D Printing: From Deep Sea to the Moon." In *Low-Cost 3D Printing, for Science, Education & Sustainable Development*, edited by E. Canessa, C. Fonda, and M. Zennaro. Trieste: ICTP, 127–132.
- Ekenel, Mahmut, and Melissa Sanchez. 2019. "Keeping Pace with Advances in 3D Automated Construction Technology," *Building Safety Journal*. <https://www.iccsafe.org/building-safety-journal/bsj-technical/keeping-pace-with-advances-in-3d-automated-construction-technology/>.
- Global Cement and Concrete Association (GCCA). 2020. "Concrete – The World's Most Widely Used Material." GCCAssociation.org. <https://gccassociation.org/news/concrete-the-worlds-most-widely-used-material-targets-carbon-neutral-future/>.
- Hambach, M., and D. Volkmer. 2017. "Properties of 3D-Printed Fiber-Reinforced Portland Cement Paste," *Cement and Concrete Composites* 79: 62–70.
- ICON – 3D Tech. 2020. "ICON – 3D Printing 2,000 Square-Foot Homes," YouTube video, 1:00. <https://www.youtube.com/watch?v=a9cmTJw5cf0>.
- Khoshnevis, Behrokh. 2004. "Automated Construction by Contour Crafting-Related Robotics and Information Technologies," *Automation in Construction* 13 (1): 5–19. <https://doi.org/10.1016/j.autcon.2003.08.012>.
- Khoshnevis, Behrokh, and Rosanne Dutton. 1998. "Innovative Rapid Prototyping Process Makes Large Sized, Smooth Surfaced Complex Shapes in a Wide Variety of Materials," *Materials Technology* 13 (2): 53–56. <https://doi.org/10.1080/10667857.1998.11752766>.

- Khoshnevis, Behrokh, Dooil Hwang, Ke-Thia Yao, and Zhenghao Yeh. 2006. "Mega-Scale Fabrication by Contour Crafting," *International Journal of Industrial and Systems Engineering* 1: 301–320. <https://doi.org/10.1504/IJISE.2006.009791>.
- Khoshnevis, Behrokh., R. Russel, H. Kwon, and S. Bukkapatnam. 2001. "Contour Crafting—A Layered Fabrication Technique," Special Issue of *IEEE Robotics and Automation Magazine* 8 (3): 33–42.
- Koebel, C. Theodore, Maria Papadakis, Ed Hudson, and Marilyn Cavell. 2004. *Diffusion of Innovation in the Residential Building Industry*. U.S. Department of Housing and Urban Development, Office of Policy Development and Research. https://www.huduser.gov/publications/pdf/diffusion_report.pdf.
- Institute of Advanced Architecture of Catalonia (IAAC). 2014. "Minibuilders." [iaac.net](https://iaac.net/project/minibuilders/). <https://iaac.net/project/minibuilders/>.
- Llatas, C. 2011. "A Model for Quantifying Construction Waste in Projects According to the European Waste List," *Waste Management* 31 (6):1261–1276.
- Nematollahi, Behzad, Ming Xia, and Jay Sanjayan. 2017. "Current Progress of 3D Concrete Printing Technologies." In *2017 Proceedings of the 34rd ISARC*, Taipei, Taiwan, 260–267.
- Occupational Safety and Health Administration (OSHA). 2004. *Concrete Manufacturing, Workers Safety Series*. Washington: OSHA.
- Raatz, A., H. Lindemann, R. Gerbers, S. Ibrahim, F. Dietrich, E. Herrmann, K. Dröder, and H. Kloft. 2019. "Development of a Shotcrete 3D-Printing (SC3DP) Technology for Additive Manufacturing of Reinforced Freeform Concrete Structures." In *First RILEM International Conference on Concrete and Digital Fabrication – Digital Concrete 2018*. Springer International Publishing.
- Ting, Guan Heng Andrew, Yi Wei Daniel Tay, Ye Qian, and Ming Jen Tan. 2019. "Utilization of Recycled Glass for 3D Concrete Printing: Rheological and Mechanical Properties," *Journal of Material Cycles and Waste Management* 21 (4): 994–1003.
- Young, Robin, and Serena McMahon. 2020. "World's 1st 3D Printed Neighborhood Being Built in Mexico." WBUR.org. <https://www.wbur.org/hereandnow/2020/02/06/worlds-first-3d-printed-neighborhood-mexico>.

Seismic Design Methodology for 3D Printed Concrete Buildings

Mohammad Aghajani Delavar

Hao Chen

Petros Sideris

Texas A&M University

Abstract

Designing high-quality, affordable homes using novel technology solutions adopted by the construction industry supports the building of strong, sustainable, and inclusive communities. Three-dimensional (3D) construction printing, or additive construction, has shown the potential to revolutionize the construction industry and the housing market, and by extension, support the U.S. Department of Housing and Urban Development (HUD) strategic plan to increase construction productivity and the production of affordable resilient housing. However, the lack of design methodologies and experimental validations that would enable the developed housing solutions to comply with building codes hinders widespread implementation of this technology. This study proposes a 3D printed concrete (3DPC) building design that adopts a lateral force resisting system composed of reinforced 3DPC walls, making it suitable for low-rise 3DPC housing in seismic regions. This proposed design process adopts the Equivalent Lateral Force (ELF) procedure as a design methodology, and this study sets to determine response modification factors (R-factors) and develop strength design equations for different failure mechanisms, which are crucial elements of the ELF procedure.

The proposed strength design equations are derived by adopting concepts from the design of masonry structures and will be experimentally validated by four different full-scale 3DPC walls under lateral loading to failure. Following experimental validation, the proposed design strategy will become available to the construction industry via relevant documentation to be used for the design of low-rise 3DPC residential and commercial buildings. Funding provided by HUD has been essential to executing this research, which will benefit those in need of affordable housing, thus aligning with some of the primary goals of HUD. This work—and construction 3D printing as a whole new industry—will contribute to transforming the housing market by rapidly providing affordable housing that will be more resilient to natural hazards. Recent studies have shown that more than 3.8 million homes are needed in the United States alone, and construction labor to provide housing is currently in decline.

Introduction

Additive construction, also known as construction 3D printing, has grown rapidly over the past decade. Construction 3D printing can address major challenges of the construction industry, such as high homeownership costs and stagnant or declining productivity through automation that will allow for rapid construction and much lower construction costs. Construction 3D printing can also reduce the environmental impact of construction by drastically reducing construction waste (by 30 to 60 percent; [Labonnote, et al., 2016]), eliminating dust particle pollution (Hager, Golonka, and Putanowicz, 2016) and the need for formwork (El-Sayegh, Romdhane, and Manjikian, 2020), which is usually discarded after being used only three or four times on average.

According to the Rider Levett Bucknall (RLB, 2021) quarterly construction cost report, national construction costs saw their biggest quarter-to-quarter increase in 2021 in more than 20 years. The U.S. national average increase in construction costs from January 2021 to April 2021 was approximately 2.91 percent (11.64 percent annualized). A large portion of that cost increase came from construction labor costs, which typically account for 30 to 50 percent of total project construction costs (Apis Cor, 2021), and those costs are particularly affected by the decline in available construction labor. In fact, according to Rider Levett Bucknall (RLB, 2022), a significant workforce shortage currently hinders the construction industry's ability to increase its construction activity (RLB, 2022). Moreover, Habitat for Humanity (2017) reported that an estimated 1.6 billion people around the world live in inadequate shelter or no shelter, which is attributed to rapid population growth and the construction productivity decline. HUD reported, "On a single night in January 2020, 580,466 people experienced homelessness across the United States" (HUD, 2022). Recent studies have concluded that the United States is experiencing a shortage of more than 3.8 million available homes (Badger and Washington, 2022; Freddie Mac, 2021). To promote homeownership and ensure broad access to affordable housing—one of the strategic goals in the *FY 2022–2026 HUD Strategic Plan* (HUD, 2022)—construction of cheaper housing is needed. Construction 3D printing can help increase productivity via automation while significantly decreasing construction labor needs and creating new, better paying jobs.

Another major issue in the construction industry is the production of significant amounts of construction waste. The U.S. Environmental Protection Agency (EPA) estimates that 230 to 530 million tons of construction and demolition waste are produced each year, which accounts for more than twice the amount of all other municipal solid waste combined (EPA, 2017). Reduction in material use or use of recyclable materials could significantly contribute to reducing construction waste.

Large-scale additive construction methods, such as concrete 3D printing, have the potential to address these major challenges faced by the construction industry. Concrete 3D printing is a sustainable, low-waste construction method that helps to reduce the impact of construction and demolition waste on the planet (Apis Cor, 2021; Greener Ideal Staff, 2021; Well and Anderton, 2021). Previous studies have shown that concrete 3D printing can reduce construction waste by 30 to 60 percent, labor costs by 50 to 80 percent, and production times by 50 to 70 percent (Comminal et al., 2020). Therefore, the automation introduced by concrete 3D printing can significantly increase productivity and reduce labor needs while simultaneously creating upskilled job opportunities (El-Sayegh, Romdhane, and Manjikian, 2020).

Concrete 3D printing currently is spearheaded by construction automation companies that have demonstrated the much shorter construction times that can be achieved compared with more conventional construction methods, such as lightweight wood-frame housing (e.g., up to 9 times faster; Apis Cor, 2021) as well as the potential for much lower construction costs (Kreiger, Kreiger, and Case, 2019; Schuldt et al., 2021; Tobi et al., 2018). However, widespread implementation of this technology—which could widely benefit the public via more resilient, more rapidly built, and cheaper housing—is hindered by the following:

- Lack of design methodologies for 3DPC elements.
- Lack of accepted structural designs for 3DPC elements and structures.
- Lack of understanding of the response of 3DPC elements—and, by extension, 3DPC structures—under loads, such as seismic loads, which are present in most parts of the country.

To enable widespread implementation of 3DPC technologies in the construction industry, this project will contribute to filling these gaps by (1) proposing a 3DPC wall design to be used as part of the lateral force resisting system of 3DPC structures; (2) developing strength design equations for the proposed 3DPC wall design, considering a range of potential failure mechanisms, and building upon existing design codes; and (3) determining a suitable response modification factor, also called R-factor, for use of the Equivalent Lateral Force (ELF) procedure (ASCE, 2016)—a widely used seismic design method—in the design of 3DPC housing. The proposed wall design and design equations will be validated using an experimental program on large-scale 3DPC walls subjected to in-plane lateral loading and via computer simulations, and a suitable R-factor will be determined by applying the FEMA P695 methodology (FEMA, 2009). Overall, the widespread implementation of construction 3D printing supported by this project aligns with all five strategic goals of HUD’s strategic plan by (1) supporting underserved communities and reducing homelessness; (2) increasing the production of affordable housing; (3) promoting homeownership opportunities; (4) advancing sustainable communities through strengthening climate resilience and energy efficiency; and (5) strengthening HUD’s internal capacity through better delivery of HUD’s mission and elevating the customer perspective across HUD.

Proposed Wall Design

Three-dimensional printed concrete (3DPC) walls have major similarities with reinforced concrete block (CB) walls in that (1) both include vertical cells, some of which can be grouted; (2) both are built through vertical deposition of “building blocks”—fresh concrete in 3DPC construction vs. hardened concrete blocks in CB construction; and (3) both include weak horizontal interfaces—the layer-to-layer interface in 3DPC construction vs. the block-to-block mortar interface in CB construction. Those similarities have been identified by 3DPC construction companies, such as Apis Cor, which introduced a 3DPC wall design in 2019 that closely follows the cross-section of typical CB walls (see exhibit 1), tested the compressive strength of this design’s equivalent 3DPC block, and found it to be comparable to that of CBs (Apis Cor, 2019). Despite those findings, no researchers have performed a comparison between mechanical properties of the various types of 3DPC walls and CB walls. This project takes advantage of the similarity of 3DPC walls to CB

masonry walls to develop a wall design that can be used as part of the lateral force resisting system of structures. The objective is to produce information that will be essential to later adoption of such 3DPC design into building codes.

Exhibit 1

Structural Similarity Between 3D Printed Wall and CMU

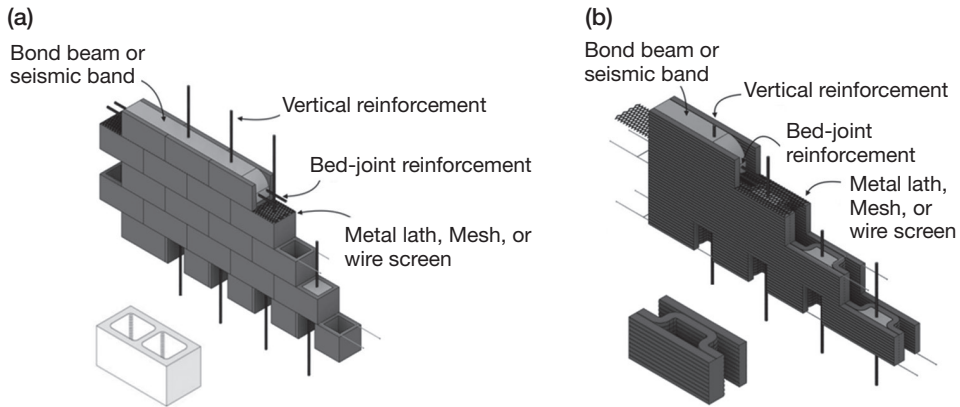

Source: Apis Cor

Primary weaknesses of 3DPC elements built from a layer-by-layer deposition process are the lack of inherent integration of steel reinforcement and the wall-to-foundation and wall-to-floor system connectivity. Three-dimensionally printed concrete buildings in seismic areas need reinforcement to provide lateral deformation capacity and load-carrying capacity. Various strategies have been proposed in the literature for integration of reinforcement in 3DPC elements, such as using steel bars (exhibit 2), integrating preinstalled reinforcement and printed concrete (exhibit 3), using textiles (exhibit 4), and using bar penetration (exhibit 5). However, not all of these solutions have been adopted in field implementation due to either inadequate available studies to demonstrate acceptable performance or insufficiently developed technologies to ensure easy implementation.

Exhibit 2

Reinforcement Strategies Using Steel Bars: (a) Placement of Straight Reinforcement Bars in the Print Plane; (b) Placement of Reinforcement in Horizontal and Vertical Directions Externally, Followed by Shotcrete; and (c) Placement of Reinforcement and Application of Grout

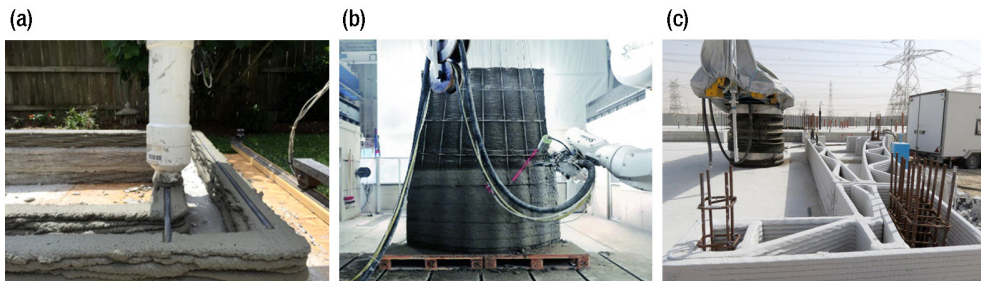

Sources: (a) Doris, 2016; (b) Hack and Kloft, 2020; (c) Apis Cor (reported by Block, 2019)

Exhibit 3

Integration of Preinstalled Reinforcement and Printed Concrete: (a) Shotcrete 3D Printing Around Preplaced Reinforcement Cage and (b) In-Situ Printing Encasing a Preplaced Reinforcement Mat Using a Split Nozzle

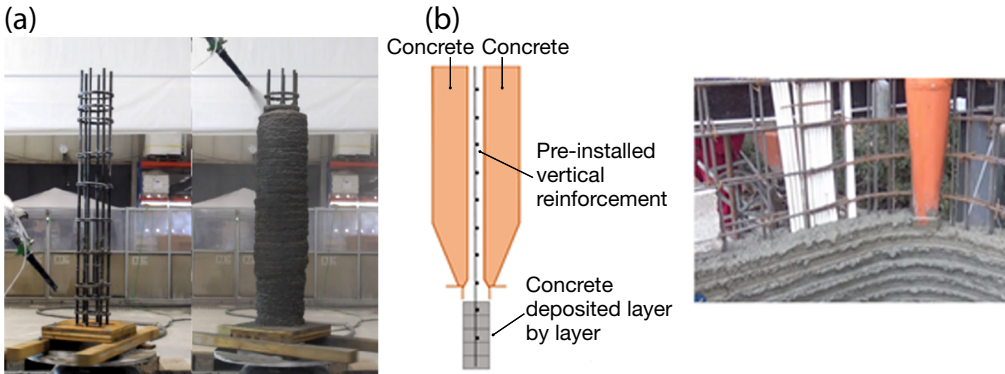

Sources: (a) Kloft et al., 2020; (b) Marchment and Sanjayan, 2020b; New China TV, 2016

Exhibit 4

Reinforcement Strategies Using Textiles: (a) Placement of Special 2.5D Textile Between Two Adjacent Printed Layers and (b) In-Process Placement of Galvanized Steel Wire Mesh in the Interlayer Direction

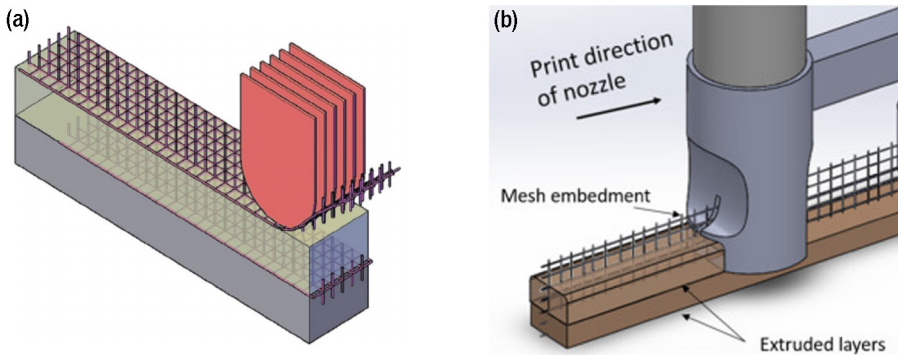

Sources: (a) Mechtcherine and Nerella, 2018; (b) Marchment and Sanjayan, 2020b

Exhibit 5

Reinforcement Strategies Using Penetration: (a) Penetration of 350-mm-Long Steel Bars Through Printed Concrete, (b) Inserting Screws Using a Combination of Translational and Rotational Movement into Freshly Printed Concrete, and (c) Vision for Penetration of Short Reinforcement Bars into Shotcrete 3D Printing Process Using an Automated Process

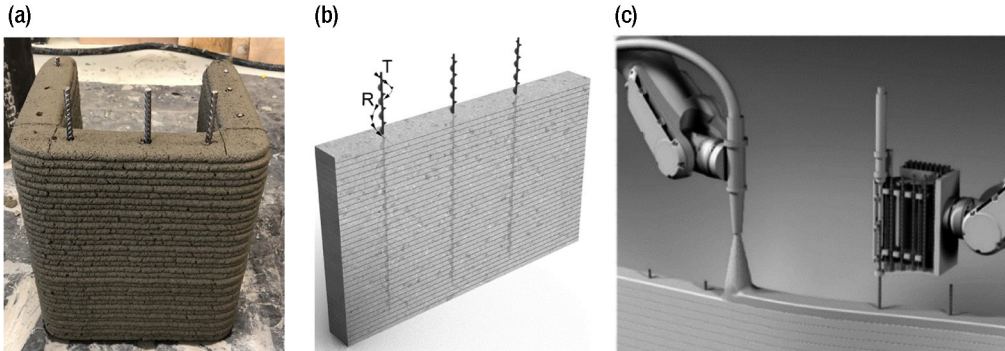

Sources: (a) Marchment and Sanjayan, 2020a; (b) Hass and Bos, 2020; (c) Freund, Dressler, and Lowke, 2020

In this project, the authors have proposed that 3DPC walls (exhibit 6) include integrated internal reinforced concrete (RC) elements that form RC frames, with partial grouting (exhibit 7) over the wall length, as needed. The RC columns may also be thought of as boundary elements, often used in masonry walls as a means of increasing their strength and ductility capacity. This project also uses ladder or truss mesh (exhibit 7) as transverse reinforcement against shear loading and to provide stability during printing. Ladder or truss mesh may also serve as flexural reinforcement for out-of-plane loading. The integrated frame, particularly the presence of the beam, is intended to allow connectivity of floor slabs using connection detailing typically adopted in precast RC framed structures or connectivity of other types of floor or roof systems as dictated by the design. The connectivity of the wall to the foundation can be achieved via the RC column elements through non-contact lap splices (i.e., overlapping longitudinal rebar) or mechanical coupling (exhibit 8). This research will adopt non-contact lap splices between steel bars protruding out of the foundation and the longitudinal and vertical bars of each column, which are practical (or almost a necessity), from a construction point of view.

Exhibit 6

3DPC Wall Design with Integrated RC Frames

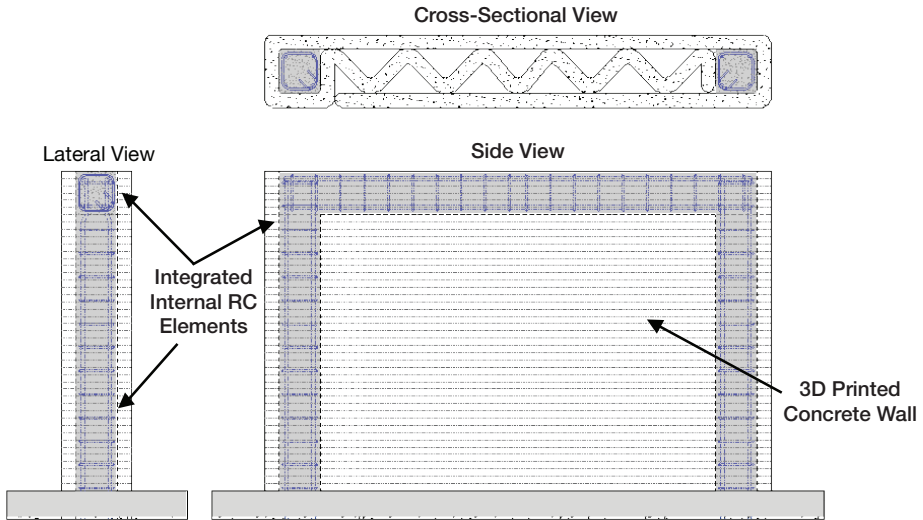

Source: Authors

Exhibit 7

3DPC Wall Design with Integrated RC Frames, Partial Grouting, and (Custom-Made) Ladder Mesh

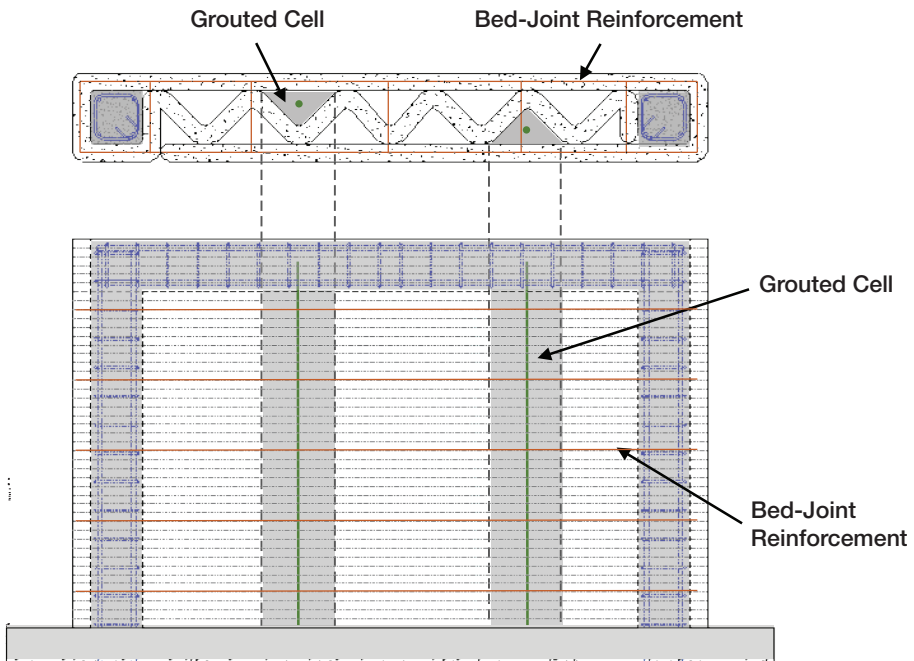

Source: Authors

Exhibit 8

Connectivity Between 3DPC Wall and Foundation

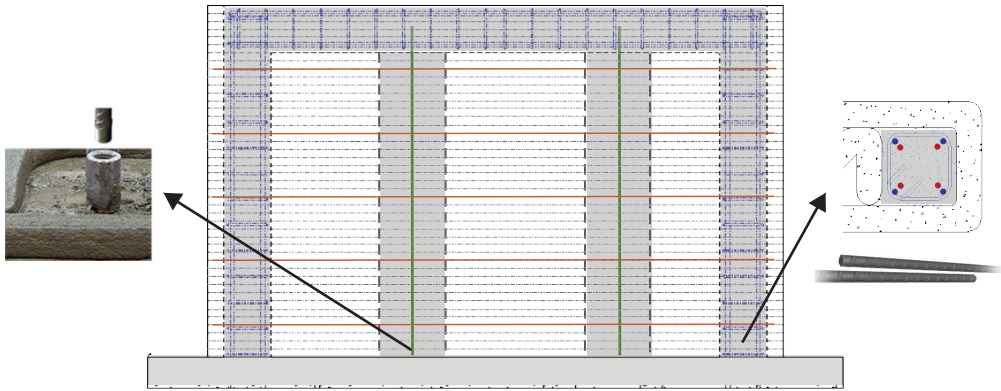

Note: Apis Cor used 3D printing to go from foundations (shown here—left photo) to a completed house near Moscow in just a day.
Sources: Authors, with photo from Apis Cor (left) and CRSI (right)

Equivalent Lateral Force (ELF) Procedure

To facilitate adoption into building codes, the authors pursue a design procedure for 3DPC housing that is compatible with the ELF procedure of *ASCE 7 Minimum Design Loads And Associated Criteria For Buildings And Other Structures* (ASCE, 2022), which is the procedure widely used by practicing engineers. Implementation of this design procedure requires design equations for the lateral capacity and stiffness of the 3DPC walls, which serve as the lateral force resisting system, and a suitable response modification factor, also called R-factor. The R-factor is used in the ELF procedure to reduce the actual seismic loads, allowing the system, which is otherwise designed through elastic analysis, to yield and deform inelastically. Permission of limited inelastic response results in lower design forces, which leads to structures with smaller size members that are more economical.

R-Factor

The R-factor for any new structural type, such as 3DPC structures, can be determined by applying the FEMA P695 collapse assessment methodology (FEMA, 2009). Essential components of this methodology are (1) the design of 3DPC building archetypes and (2) incremental dynamic analyses (IDAs) of these buildings with representative ground motions to quantify their collapse margin ratios.

The process of the methodology is summarized in exhibit 9. The first step is to acquire information about the proposed system, such as its potential application, design requirements, and test data. This information will be used in the next step to build archetypes, which are typical representations of the seismic or lateral force resisting system in common applications. The archetypes constitute a general representation of a class of buildings and are used to provide predictions of the performance of this entire new class of 3DPC buildings. To develop archetypes, the authors considered 180 building configurations, resulting from five different plan views. Those plan views, which are shown in exhibit 10, have been obtained (and modified) from available

constructed 3DPC buildings combining single- and multifamily dwellings. In this study, using these plan views, the authors designed gravity force resisting systems and seismic force resisting systems for buildings with one, two, and three stories. The building designs covered locations representing seismic design categories B_{\max} , C_{\max} , and D_{\max} , per ASCE 7 (ASCE, 2022) and were designed for four different R factors: 1, 1.5, 3, and 5.

Exhibit 9

FEMA P695 Methodology

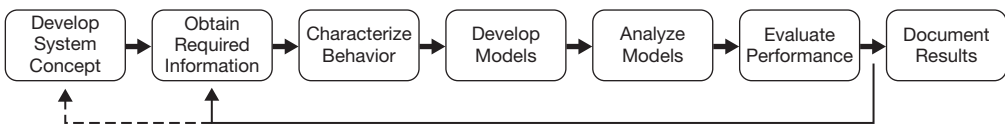

Source: FEMA, 2009

The authors developed computer models of the archetypes to investigate their overstrength and collapse margin ratio through static (pushover) and dynamic analyses, respectively. As part of the performance evaluation (exhibit 9), the authors will later use the results from nonlinear static analyses to determine an appropriate value of the system overstrength factor and results from nonlinear dynamic analyses to evaluate the acceptability of a trial value of the response modification factor, R. That process may have to be repeated several times before a suitable R-factor is determined.

Strength Design Equations

Strength design equations are essential to designing the proposed wall system. To derive design equations, the authors adopted similar design assumptions to those of TMS 402/602-16 *Building Code Requirements and Specification for Masonry Structures* (The Masonry Society, 2016). The adopted assumptions are (1) strain compatibility exists between reinforcement, printed concrete, and poured concrete; (2) all strength derivations should satisfy conditions of equilibrium; (3) the maximum usable strain is 0.0025; (4) plane sections in the undeformed configuration remain planes in the deformed configuration; (5) steel reinforcement has an elasto-plastic stress-strain response; (6) tensile strength of concrete is neglected; and (7) the equivalent average stress of the stress block is $0.8f_c$ and its depth is $a = 0.80c$ with f_c , a , and c being the concrete compressive strength, equivalent stress block depth, and location of the neutral axis from the extreme compression fiber, respectively.

The primary (potential) failure mechanisms considered for 3DPC walls subjected to in-plane loading are axial failure, flexural failure, diagonal (tension) shear failure, and interface shear failure, including interlayer shear bonding failure and bed-joint friction failure at the wall-to-foundation interface (exhibit 11).

Exhibit 10

Original Buildings Used in Archetype Development

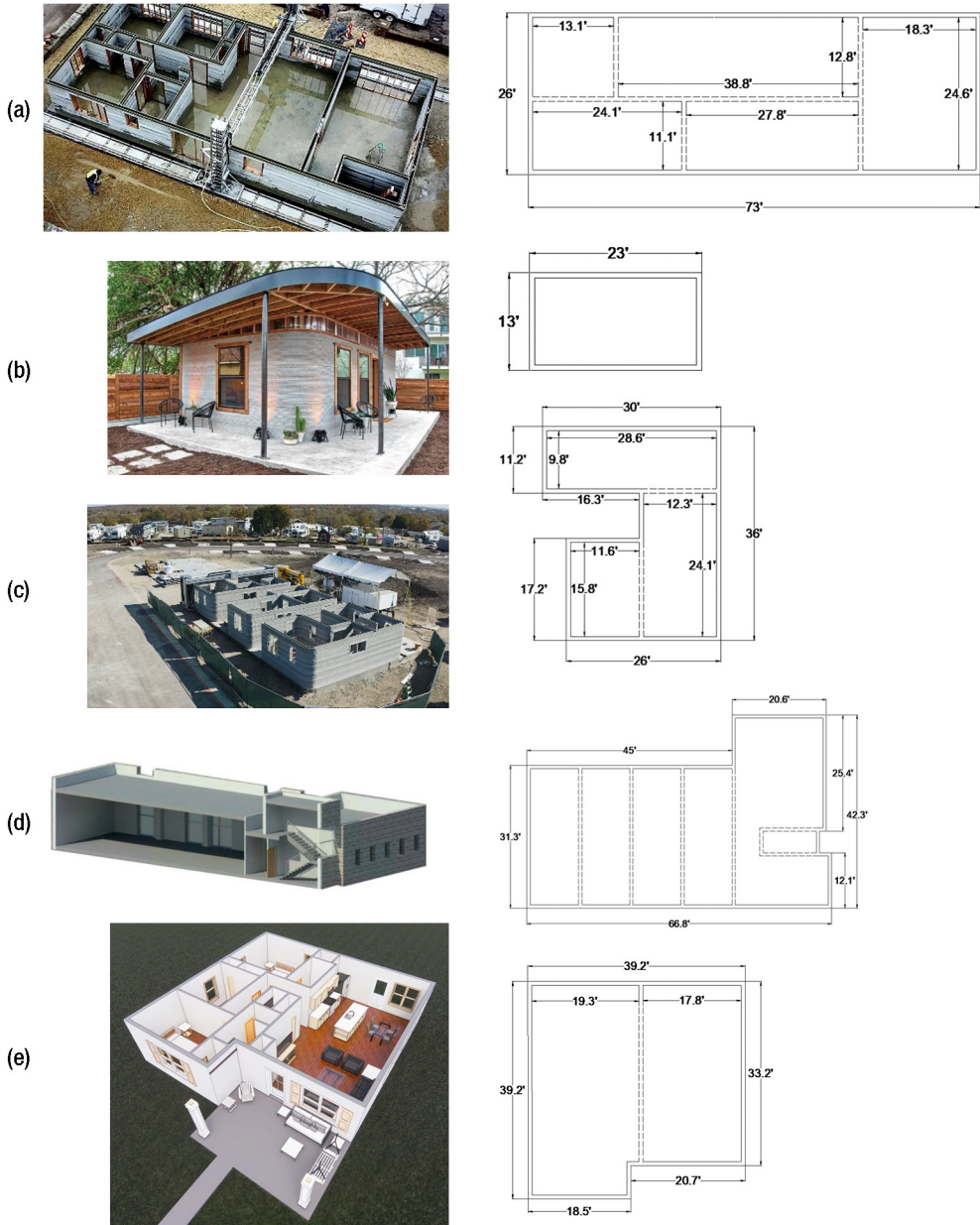

Sources: (a) Allouzi, Al-Azhari, and Allouzi, 2020; (b) ICON Team, 2018; (c) Jayson, 2020; (d) Kozlowski, 2021; (e) SQ4D, 2020

Exhibit 11

Failure Mechanisms: (a) Axial, (b) Flexural, (c) Diagonal Shear, and (d) Interface Shear Plane

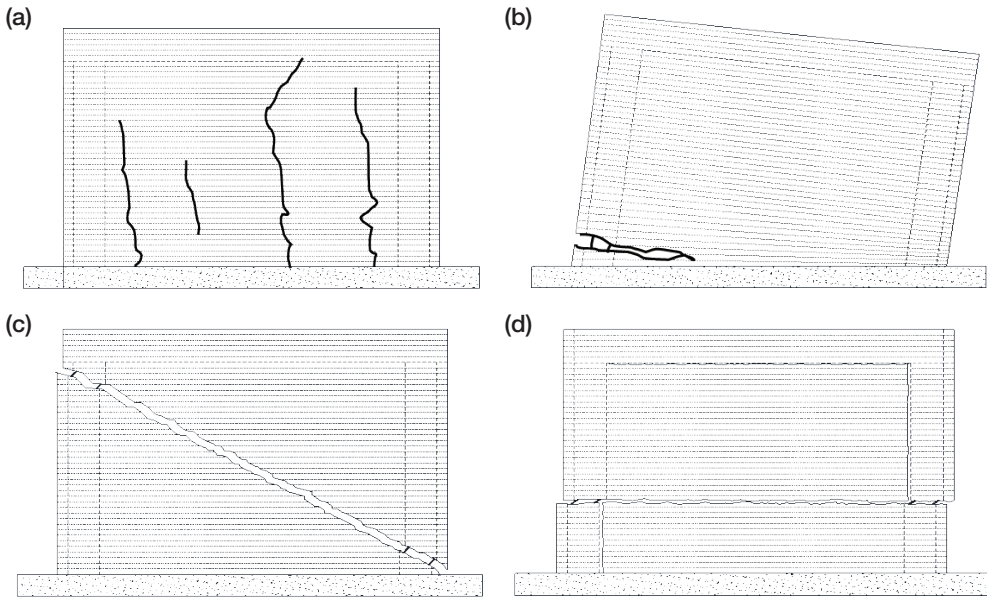

Source: Authors

To develop design equations for the different failure mechanisms in 3DPC walls, the authors built upon existing standards for masonry and structural concrete walls, such as TMS 402/602 (The Masonry Society, 2016), ASCE 7 (ASCE, 2022), ACI 318 (ACI Committee, 2019), and Eurocodes (CEN, 2006). The design equations also adopt basic principles of structural mechanics and are validated via computer simulations. Data from the authors' ongoing experimental program will be used to modify and update these design equations to more accurately predict the response of 3DPC walls (Aghajani Delavar, Chen, and Sideris, 2022a, 2022b). This research will particularly address the lack of experimental data providing information that can significantly support the understanding and future code adoption of 3DPC structures.

Axial Strength

The strength against axial compression failure in 3DPC walls is computed via sectional analysis, considering the contribution of different elements and materials in resisting axial loads. The wall cross-section (exhibit 7) consists of the deposited layered concrete, the integrated internal RC columns, and the grouted cells, all of which contribute to the resistance against axial loads, providing the total axial strength. This strength does not explicitly account for wall buckling and, for that reason, will be applicable only to low-rise construction.

Flexural Strength

In the case of flexural failure, the entire wall—including the deposited layered material, the RC frame, and the grouted cells—is assumed to react as a single element, for example, a deep beam or column, where the “plane sections” assumption is applicable. Horizontal (and vertical) reinforcement provide structural integrity between the 3DPC wall and the integrated internal RC elements. The flexural strength of the 3DPC wall can be computed through sectional analysis.

In the proposed 3DPC wall design, wall-to-foundation connectivity is provided through non-contact lap splices, as shown in exhibit 8, at the integrated internal RC columns at their maximum moment location (plastic hinge location). Therefore, to prevent brittle bond-slip failure, lap splices are designed with adequately large splice length and confinement.

Diagonal Shear Strength

Failure is expected to initiate within the 3DPC wall along the compression diagonal strut. The overall shear strength comprises the diagonal tension or shear strength of the infill wall, the shear strength provided by the horizontal bed-joint reinforcement distributed over the infill wall height, and the shear or flexural strength of the RC column. Although the dowel action of the vertical steel bars affects the shear strength, it is not considered herein, in accordance with the approach adopted by TMS 402/602 design code. In 3DPC walls, diagonal shear failure of the infill 3DPC wall may be accompanied by one of two primary responses for the integrated RC frame: (1) shear failure in the columns or (2) flexural failure or hinging of the columns. Exhibit 12 shows the free-body diagram for the x-axis during diagonal shear failure for the proposed 3DPC wall design.

Exhibit 12

Free-Body Diagram of the Wall in Shear Failure in Frame and Shear Failure in Printed Wall

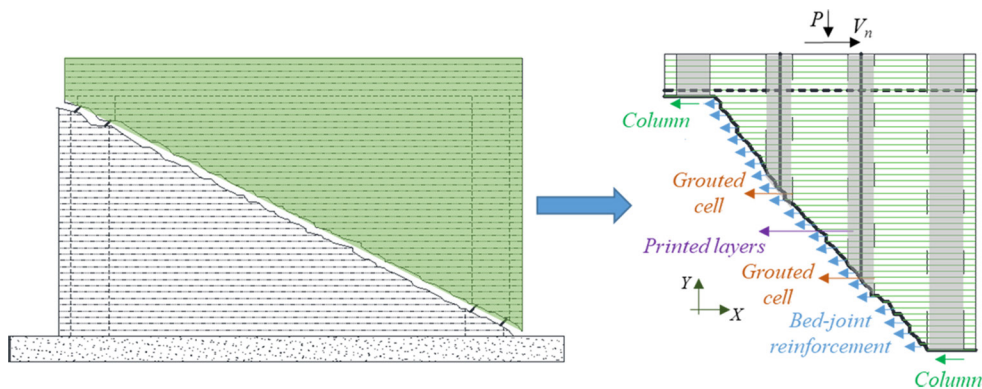

Source: Authors

Interface Shear Plane Strength

The interface shear failure mechanism may occur in the form of interlayer sliding shear failure or as friction failure at the wall-to-foundation interface. The free-body diagram shown in exhibit 13

represents the components of the interface shear strength. By applying equilibrium in the horizontal direction, the interface shear plane strength additively includes the interface bond shear strength (or the shear-friction strength between the layered material and the foundation) and the shear strengths of the columns and grouted cells.

Exhibit 13

Free-Body Diagram of the Wall in Interface Shear Plane Failure

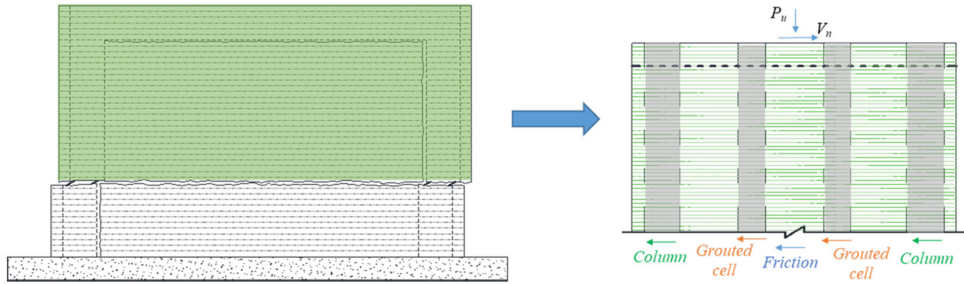

Source: Authors

Construction Process

The construction methods for 3D printed concrete buildings can be categorized in three types (exhibit 14): onsite printing, onsite construction via precast 3D printed elements, and prefabricated 3D printed housing.

Exhibit 14

Construction Methods in 3DPC Buildings: (a) Onsite Printing, (b) Onsite Construction via Precast 3DPC Elements, and (c) Prefabricated 3DPC Housing

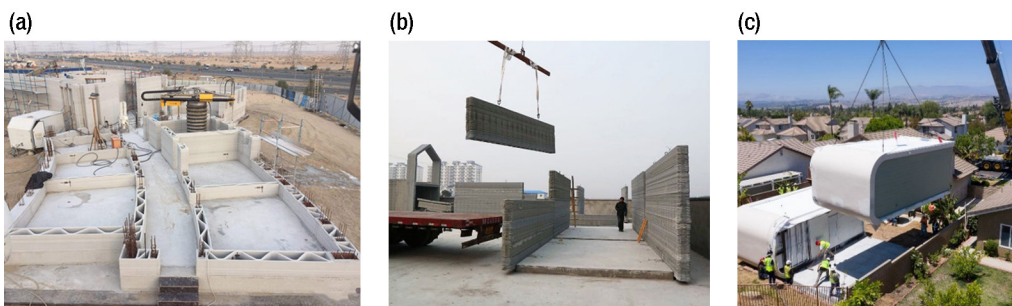

Sources: (a) Apis Cor (reported by Block, 2019); (b) Winsun, 2014; (c) Mighty Buildings, 2021

The construction process for the proposed wall design in this project—and, by extension, 3DPC housing—is simple and in accordance with available 3DPC construction methods. In fact, the 3DPC wall construction can be summarized in four steps (exhibit 15):

- Step 1: Foundation construction, which should include steel bars protruding for lap splicing with the wall columns.

- Step 2: Onsite printing or onsite assembly of precast 3DPC wall.
- Step 3: Insertion of frame steel cage into the designated location within the wall.
- Step 4: Pouring concrete into the frame columns and beam.

Following Step 4, and after development of sufficient strength, the floor-to-wall connection can be cast. This simple design methodology, together with this practical implementation, can significantly change and broadly affect the homebuilding process by enabling widespread use of construction 3D printing.

Exhibit 15

Construction Process of 3DPC Wall: (a) Step 1, (b) Step 2, (c) Step 3, and (d) Step 4

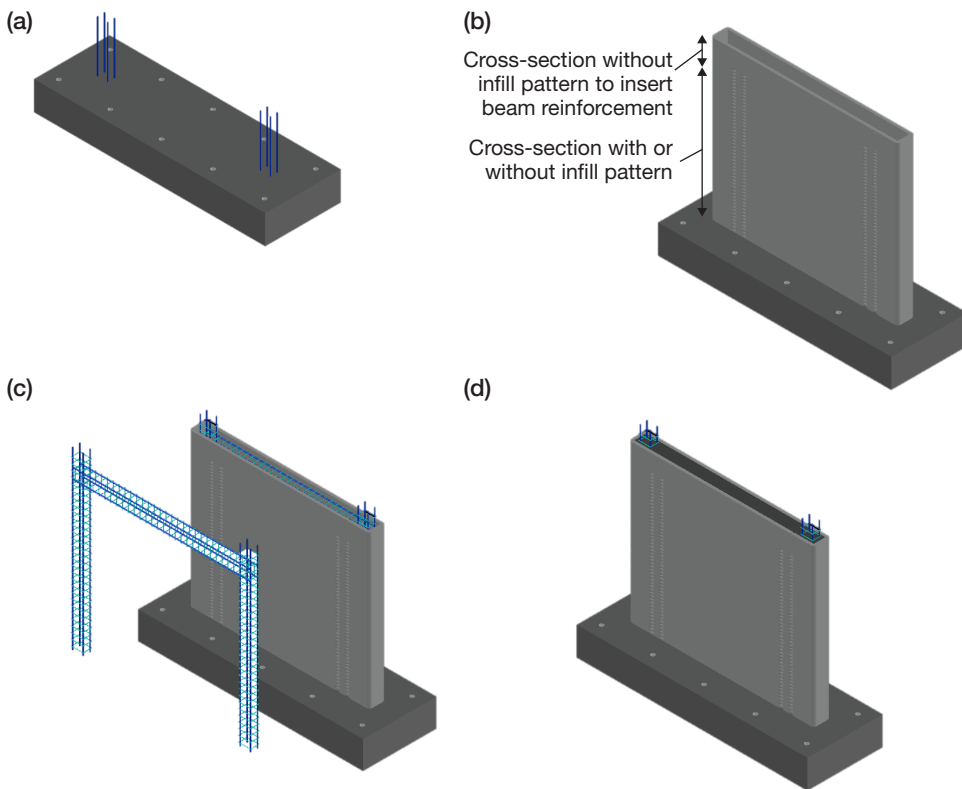

Source: Authors

Validation

To validate the proposed design equations and the proposed construction process, the authors designed four different 3DPC wall specimens and will experiment through destructive testing of the walls that will simulate seismic loads. Two of those walls are flexure critical and the other two walls are shear critical. In each pair, one wall has infill pattern and the other wall does not. All

walls include ladder mesh as the primary shear reinforcement. Also, all walls are subjected to the same axial force per unit wall length. The dimensions and cross-section patterns of the given 3DPC walls are shown in exhibits 16 and 17.

Exhibit 16

Major Properties of Wall Specimens

Specimen ID	Height (in)	Length (in)	Width (in)	P_u (kips)	Column Reinforcement		f'_{pc} (ksi)	Horizontal Reinforcement		Infill Pattern			
					f_y (ksi)	Each col.		f_y (ksi)	Type				
3DPC-1	120	130	12	130	60	4#7 Ties: #3	4.35	70	LM (9 gauge) @4 in	Yes			
3DPC-2				82		4#5 Ties: #3			LM (9 gauge) @2 in	No			
3DPC-3		82		82	82	60			4#5 Ties: #3	4.35	70	LM (9 gauge) @2 in	Yes
3DPC-4													No

LM = ladder mesh.

Source: Authors

Exhibit 17

Cross-Section Patterns of 3DPC Walls: (a) 3DPC-1, (b) 3DPC-2, (c) 3DPC-3, and (d) 3DPC-4

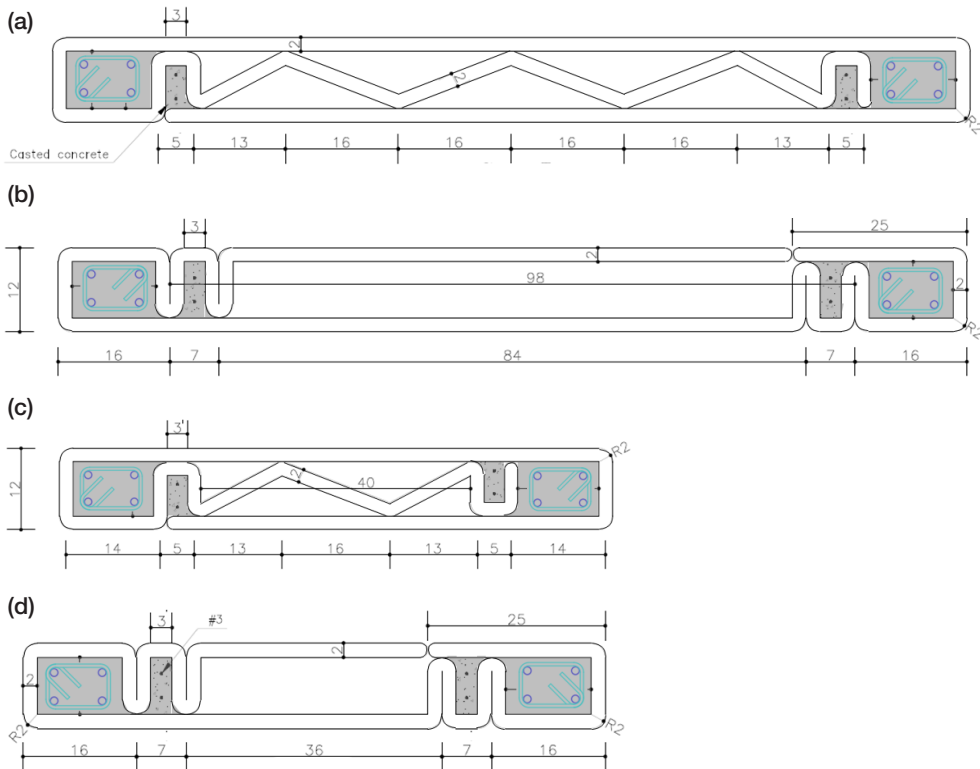

Source: Authors

All four 3DPC walls will consist of a foundation block to allow anchoring to the laboratory floor, internal RC frame, and floor slab. Exhibit 18 shows all components of the testing setup that will be used for all walls, including the wall specimen and the loading setup. The loading setup includes two vertical hydraulic actuators to apply the gravity load and one horizontal hydraulic actuator to apply lateral in-plane cyclic loading, simulating equivalent seismic demands. The response of the proposed wall designs under those loading conditions will be essential to assessing their structural performance during earthquakes.

Exhibit 18

Wall Specimen and Test Setup

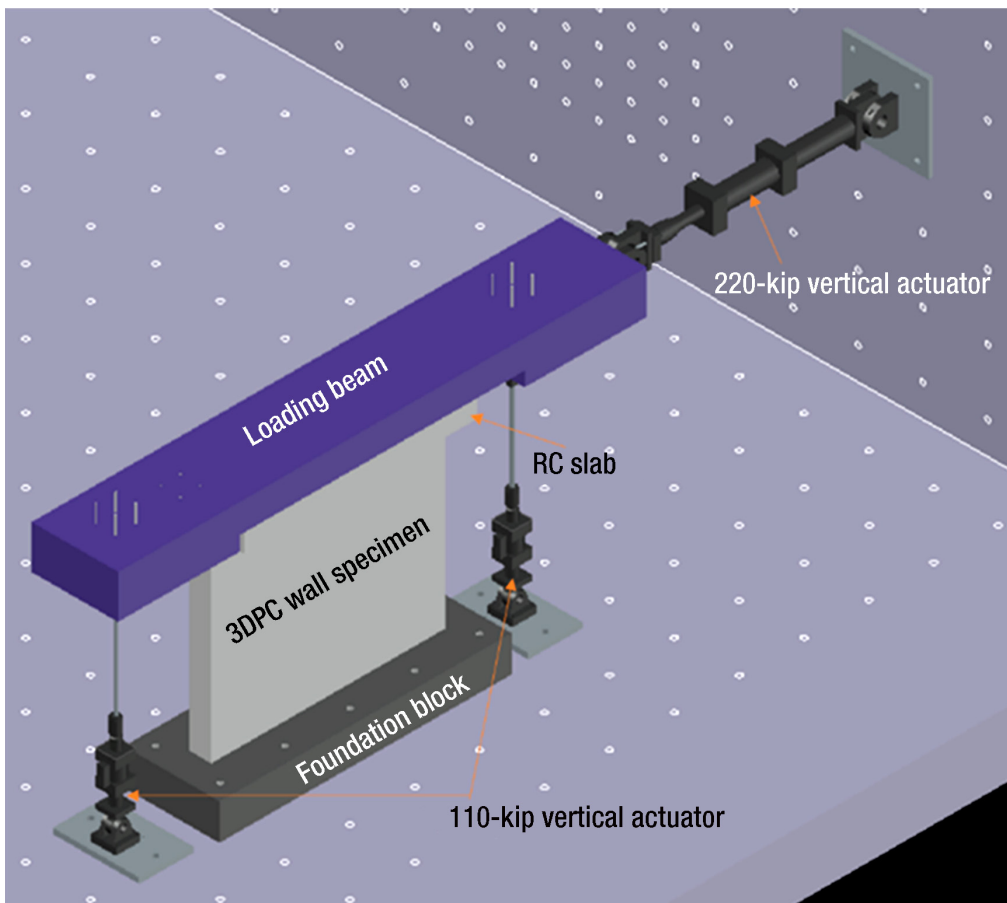

Source: Authors

The authors are currently constructing the 3DPC walls. The printed component of all walls has been printed in the Construction Engineering Research Laboratory (CERL) of the U.S. Army Engineer Research and Development Center (ERDC). These printed components will be shipped to Texas A&M University to be used in the construction of the 3DPC wall specimens.

Conclusion

This article proposes a wall design and a building design methodology suitable for seismic applications for low-rise 3D printed concrete buildings. This methodology is currently being validated through computer simulations and via an ongoing experimental study on full-scale 3DPC walls. The proposed design methodology and the associated experimental study will support widespread implementation of concrete 3D printing in the construction industry to achieve all five strategic goals in the HUD *Fiscal Year 2022–2026 Strategic Plan*.

Due to similarities between concrete block masonry and 3DPC buildings, the general design methodology and the construction process for 3DPC buildings follow those for masonry buildings but adopt design equations proposed by the authors. Because this design process for low-rise 3DPC residential and commercial buildings is based on relevant processes used in masonry buildings, it may be more easily accepted by various stakeholders, such as construction technology companies, engineering firms, and local jurisdictions. Despite the increasing need for affordable housing, design and construction processes for 3DPC structures have been limited to date. Such limited availability of design and construction processes may also contribute to integration of the findings and developments of this research effort into design documents that can be used by design engineers. Future research may focus on experimental studies investigating the axial and out-of-plane strength of 3DPC walls.

Acknowledgments

The authors gratefully acknowledge the financial support provided by the U.S. Department of Housing and Urban Development (HUD) for this research under grant number H-21691CA. Further, the authors thank Jagruti Rehki for managing and coordinating this work on HUD's behalf. The authors also thank the editors and two referees for their helpful comments. Finally, the authors thank Mr. Eric Kreiger for his feedback during the printing of the 3DPC walls at the Construction Engineering Research Laboratory of the USACE.

Authors

Mohammad Aghajani Delavar is a PhD candidate and graduate student researcher in the Zachry Department of Civil and Environmental Engineering at Texas A&M University. Hao Chen is a PhD candidate and graduate student researcher in the Zachry Department of Civil and Environmental Engineering at Texas A&M University. Dr. Petros Sideris is an assistant professor in the Zachry Department of Civil and Environmental Engineering at Texas A&M University.

References

Aghajani Delavar, Mohammad, Hao Chen, and Petros Sideris. 2022a. “Analytical and Numerical Investigation of Out-of-Plane Behavior of 3D Printed Concrete Walls.” Paper presented at the 12th National Conference on Earthquake Engineering, Salt Lake City, UT, June 27–July 1.

———. 2022b. “Design of 3D Printed Concrete Walls Under In-Plane Seismic Loading.” Paper presented at the 12th National Conference on Earthquake Engineering, Salt Lake City, UT, June 27–July 1.

Allouzi, Rawan, Wael Al-Azhari, and Rabab Allouzi. 2020. “Conventional Construction and 3D Printing: A Comparison Study on Material Cost in Jordan,” *Journal of Engineering* 2020: 1424682.

American Concrete Institute (ACI) Committee. 2019. *Building Code Requirements for Structural Concrete (ACI 318-19)*. Farmington Hills, MI: ACI.

American Society of Civil Engineers (ASCE). 2022. *Minimum Design Loads and Associated Criteria for Buildings and Other Structures (ASCE/SEI 7-22)*. Reston, VA: ASCE.

———. 2016. *Minimum Design Loads and Associated Criteria for Buildings and Other Structures (ASCE/SEI 7-16)*. Reston, VA: ASCE.

Apis Cor. 2021. “Fundamentals of Construction 3D Printing.” Apis Cor University Course C3D-1100. <https://apis-cor.thinkific.com/courses/fundamentals-of-construction-3d-printing-c3d-1100>.

———. 2019. “3D Printed Structures as Comparable to Masonry Construction.” <https://www.nfpa.org/-/media/Files/News-and-Research/Publications-and-media/NFPA-Journal/2020/March-April-2020/APIS-COR-REPORT.ashx>.

Badger, Emily, and Eve Washington. 2022. “The Housing Shortage Isn’t Just a Coastal Crisis Anymore,” *The New York Times*, July 14. <https://www.nytimes.com/2022/07/14/upshot/housing-shortage-us.html>.

Block, India. 2019. “World’s Largest 3D-Printed Building Completes in Dubai.” <https://www.dezeen.com/2019/12/22/apis-cor-worlds-largest-3d-printed-building-dubai/>.

Comité Européen de Normalisation (CEN; European Committee for Standardization). 2006. “Eurocode 6: Design of Masonry Structures—Part 2: Design Considerations, Selection of Materials and Execution of Masonry.” <http://www.gaprojekt.com/sites/default/files/legislation/Eurocode%206%20-%20Design%20of%20masonry%20structures%20-%20Part%202%20-%20en.1996.2.2006.pdf>.

Comminal, Raphaël, Wilson Ricardo Leal da Silva, Thomas Juul Andersen, Henrik Stang, and Jon Spangenberg. 2020. “Modelling of 3D Concrete Printing Based on Computational Fluid Dynamics,” *Cement and Concrete Research* 138: 106256.

Concrete Reinforcing Steel Institute (CRSI). n.d. “Lap Splices.” <https://www.crsi.org/reinforcing-basics/reinforcing-steel/splicing-bars/lap-splices/>.

- Doris. 2016. "V2 Vesta Beton-3D-Drucker baut kleines Haus." <https://3druck.com/drucker-und-produkte/v2-vesta-beton-3d-drucker-baut-kleines-haus-2846225/>.
- El-Sayegh, Sameh, Lotfi Romdhane, and Solair Manjikian. 2020. "A Critical Review of 3D Printing in Construction: Benefits, Challenges, and Risks," *Archives of Civil and Mechanical Engineering* 20 (2): 1–25.
- Federal Emergency Management Agency (FEMA). 2009. *Quantification of Building Seismic Performance Factors (FEMA P695)*. Washington, DC: FEMA.
- Federal Home Loan Mortgage Corporation (Freddie Mac) 2021. "Housing Supply: A Growing Deficit." Economic & Housing Research Note. McLean, VA: Freddie Mac. http://www.freddiemac.com/fmac-resources/research/pdf/202105-Note-Housing_Supply-08.pdf.
- Freund, Niklas, Inka Dressler, and Dirk Lowke. 2020. "Studying the Bond Properties of Vertical Integrated Short Reinforcement in the Shotcrete 3D Printing Process." In *Second RILEM International Conference on Concrete and Digital Fabrication*, edited by Freek P. Bos, Sandra S. Lucas, Rob J.M. Wolfs, and Theo A.M. Salet. New York: Springer: 612–621.
- Greener Ideal Staff. 2021. "3D Printing: The Next Big Thing in Sustainable Housing?" <https://greenerideal.com/news/building/3d-printing-the-next-big-thing-in-sustainable-housing/>.
- Habitat for Humanity. 2017. "Statement by Habitat for Humanity About the Future of the United Nations Human Settlement Programme, UN-Habitat." <https://www.habitat.org/newsroom/2017/statement-habitat-humanity-about-future-united-nations-human-settlement-programme-un>.
- Hack, Norman, and Harland Kloft. 2020. "Shotcrete 3d Printing Technology for the Fabrication of Slender Fully Reinforced Freeform Concrete Elements with High Surface Quality: A Real-Scale Demonstrator." In *Second RILEM International Conference on Concrete and Digital Fabrication*, edited by Freek P. Bos, Sandra S. Lucas, Rob J.M. Wolfs, and Theo A.M. Salet. New York: Springer: 1128–1137.
- Hager, Izabela, Anna Golonka, and Roman Putanowicz. 2016. "3D Printing of Buildings and Building Components as the Future of Sustainable Construction?" *Procedia Engineering* 151: 292–299.
- Hass, Lauri, and Freek Bos. 2020. "Bending and Pull-Out Tests on a Novel Screw Type Reinforcement for Extrusion-based 3D Printed Concrete." In *Second RILEM International Conference on Concrete and Digital Fabrication*, edited by Freek P. Bos, Sandra S. Lucas, Rob J.M. Wolfs, and Theo A.M. Salet. New York: Springer: 632–645.
- ICON Team. 2018. "New Story and ICON Unveil the First Permitted 3D-Printed Home." Austin, TX: ICON. <https://www.iconbuild.com/updates/new-story-and-icon-unveil-the-first-permitted-3d-printed-home>.
- Jayson, Sharon. 2020. "Around the Corner: 3D Housing Designed for the Homeless and Needy Seniors." KHN. <https://khn.org/news/3d-printed-housing-designed-for-the-homeless-and-needy-seniors/>.
- Kloft, Harald, Martin Empelmann, Norman Hack, Eric Herrmann, and Dirk Lowke. 2020. "Reinforcement Strategies for 3D-Concrete-Printing," *Civil Engineering Design* 2 (4): 131–139.

Kozłowski, Jonathan. 2021. "Two 3D-Printed Concrete Projects Bring the Concept Home to the US." <https://www.forconstructionpros.com/concrete/article/21521268/3d-printed-concrete-home-breaks-ground-in-virginia>.

Kreiger, Eric L., Megan A. Kreiger, and Michael P. Case. 2019. "Development of the Construction Processes for Reinforced Additively Constructed Concrete," *Additive Manufacturing* 28: 39–49.

Labonnote, Nathalie, Anders Rønquist, Bendik Manum, and Penda Rütther. 2016. "Additive Construction: State-of-the-Art, Challenges and Opportunities," *Automation in Construction* 72: 347–366.

Marchment, Taylor, and Jay Sanjayan. 2020a. "Bond Properties of Reinforcing Bar Penetrations in 3D Concrete Printing," *Automation in Construction* 120: 103394.

———. 2020b. "Mesh Reinforcing Method for 3D Concrete Printing," *Automation in Construction* 109: 102992.

The Masonry Society. 2016. *TMS 402/602-16: Building Code Requirements and Specification for Masonry Structures*. Longmont, CO: The Masonry Society.

Mechtcherine, Viktor, and Venkatesh Naidu Nerella. 2018. "Integration der Bewehrung beim 3D-Druck mit Beton," *Beton- und Stahlbetonbau* 113 (7): 496–504.

Mighty Buildings. 2021. "See the First 3D Printed Home in the County." <https://www.vcstar.com/picture-gallery/news/local/2021/07/24/see-first-3-d-printed-home-county/8051990002/>.

New China TV. 2016. "World's First 3D-Printed House that Can Withstand 8.0-Magnitude Quake." YouTube video. https://www.youtube.com/watch?v=OloOc21_u80.

Rider Levett Bucknall. 2022. "Quarterly Construction Cost Report: North America Q2 2022." <https://www.rlb.com/americas/insight/rlb-construction-cost-report-north-america-q2-2022/>.

———. 2021. "RLB Construction Cost Report: North America Q2 2021." <https://www.rlb.com/americas/insight/rlb-construction-cost-report-north-america-q2-2021/>.

Schuldt, Steven J., Jeneé A. Jagoda, Andrew J. Hoisington, and Justin D. Delorit. 2021. "A Systematic Review and Analysis of the Viability of 3D-Printed Construction in Remote Environments," *Automation in Construction* 125: 103642.

SQ4D. 2020. "Largest Permitted 3D Printed Home." <https://www.sq4d.com/largest-3d-printed-home/>.

Tobi, Abdul Latif Mohd, S.A. Omar, Z. Yehia, S. Al-Ojaili, A. Hashim, and O. Orhan. 2018. "Cost Viability of 3D Printed House in UK." *IOP Conference Series: Materials Science and Engineering* 319 (1): 012061.

U.S. Department of Housing and Urban Development (HUD). 2022. "Fiscal Year 2022–2026 Strategic Plan." <https://www.hud.gov/sites/dfiles/CFO/documents/FY2022-2026HUDStrategicPlan.pdf>.

U.S. Environmental Protection Agency (EPA). 2017. *The State of the Practice of Construction and Demolition Material Recovery: Final Report*. EPA/600/R-17/231. <https://nepis.epa.gov/Exe/ZyPDF.cgi/P100SSJP.PDF?Dockey=P100SSJP.PDF>.

Well, Caleigh, and Frances Anderton. 2021. "Wasted: Reducing Construction Waste with Giant 3D Printers." <https://www.kcrw.com/news/shows/greater-la/construction-housing-waste-quake/wasted-3d-printed-buildings>.

Winsun. 2014. "3D Printed Buildings Speed Up Construction." <https://greenbuildingelements.com/3d-printed-buildings-speed-construction/>.

Residential House Foundations on Expansive Soils in Changing Climates

Nafisa Tabassum

Rifat Bulut

School of Civil and Environmental Engineering, Oklahoma State University

Abstract

Today, communities are vulnerable to extreme weather events, natural disasters, and geologic hazards resulting from changing climates. The U.S. Department of Housing and Urban Development (HUD) aims to provide sustainable, resilient, energy efficient, and healthy homes to its stakeholders. HUD has a great opportunity to invest in climate resiliency to achieve the goal of advancing sustainable communities. Climate change has increased the risk of exacerbating geologic hazards, especially under extreme events like excessive precipitation and drought or shifting patterns of climatic extremes. Lightweight structures with shallow foundations, such as residential houses with slab-on-ground foundations built on expansive soils, are more vulnerable to climate-related challenges than those situated on sites with non-expansive soils (Diaz and Moore, 2017; Mostafiz et al., 2021). Therefore, current design codes and methods need to be improved to mitigate the problems of slab-on-ground foundations of residential houses constructed over expansive soils.

Expansive soils are well-known geologic hazards for residential homes. Even without the exacerbating effects of climate change, they can cause extensive problems to foundations due to their swelling and shrinking characteristics. Expansive soils swell when water enters the soil and shrink when the soil dries out. These swelling and shrinking cycles can lead to severe cracks in foundations and walls and can cause other damages. When foundations are not designed to withstand the movements of expansive soils, houses will begin to show signs of distress in the form of cracks. As the walls move, the cracks begin to appear and, thereafter, progressively, doors start to jam, floors tilt, and structural integrity may diminish. These damages, whether they are at cosmetic levels or more severe but not at a structural failure state, can have multiple consequences, such as reduced service life of the structure, reduction of energy efficiency caused by increased air leakage and heat exchange through cracks or voids in walls and foundations, and loss of durability due to water intrusion. These same consequences can also cause emotional distress, loss of property value with the prospect of costly repairs, and affect occupant health due to impaired indoor environmental and air quality.

In the United States, in addition to many locally supported and practiced design methods, the current Post-Tensioning Institute (PTI) design code DC10.5-19 is widely recognized across many states (Vann and Houston, 2021). PTI DC10.5-19, "Standard Requirements for Design and Analysis of Shallow

Abstract (continued)

Post-Tensioned Foundations on Expansive and Stable Soils,” is a more rational method compared with its predecessor versions, and it is based partly on unsaturated soil mechanics principles. However, it still contains some major shortcomings. The use of unsaturated mechanics, climatic and other moisture boundary conditions, soil properties, and soil-structure interface can be used in a more rational way following current knowledge. With these improvements, it is possible to better predict the performance of houses and better manage the risk and potential consequences of building on expansive soils. With the financial support that HUD provided, this research study aimed at developing several design modules that use the principles of unsaturated soil mechanics and soil-structure interaction. These modules reflect the most recent advances and current thought.

Introduction

A significant number of residential houses in the United States have been built on expansive soils, and among those houses, a considerably high number are likely to have performance issues (Mostafiz et al., 2021). In the early 1950s, the development of design procedures for slab-on-ground foundations followed an empirical approach based on experience. During the 1960s, the Federal Housing Administration, a HUD precursor, initiated a research study to develop design methods for slab-on-ground foundations. That study, in the literature, is known as the “BRAB Method” (BRAB, 1968). The BRAB method identified four basic slab-on-ground slab types based on soil properties, climatic conditions, and functional levels. After BRAB, several different approaches began to appear at the local and national levels. However, all these methods or standards were still mostly based on experience and did not contain many of the mechanics-based techniques. For the most part, many of them were inconsistent and very different from each other in terms of climatic and soil design parameters and types of structural slabs.

Designing foundations on expansive soils has always been a great challenge for any geotechnical engineer due to its unique swelling and shrinkage characteristics. It is essential to examine buildings these soils affect to grasp the behavior of their foundations. Expansive soils contain very fine clay minerals (smaller than $2\mu\text{m}$) that swell when they absorb moisture and shrink when they lose moisture. This moisture cycle is a key factor for volume changes in expansive soils. Differential soil movement takes place as a result of nonuniform moisture distribution within the soil beneath the foundation, causing significant damages to lightweight structures, particularly shallow residential slabs-on-ground. If the soil below the slab undergoes a change in its moisture content after the construction of the slab, it will twist into one of two worst-case modes—center lift or edge lift. The center lift, or edge drop, condition occurs when the moisture level of the soil surrounding the slab perimeter slowly drops, and the soil shrinks, or compresses, by comparison with the soil underneath the interior of the slab. On the contrary, the edge lift case arises when the soil below the perimeter of the house becomes wetter than the soil beneath the interior of the slab, causing it to expand, or swell. Exhibit 1 illustrates both center lift and edge lift modes of a shallow slab-on-ground situated on expansive soils.

Exhibit 1

Center Lift and Edge Lift Modes of Slabs on Expansive Soils (Left) and Damage Caused by Expansive Soils (Right)

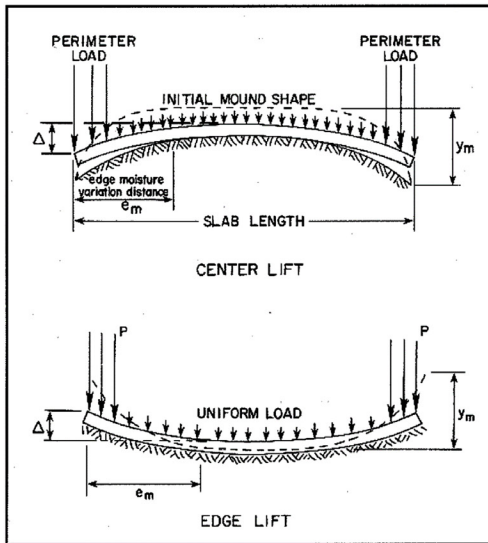

Sources: Post-Tensioning Institute, 2004; Zhang and Briaud, 2015

Each year, residential homes across the United States are exposed to adverse and extreme climatic events (Jones and Jefferson, 2012; Mostafiz et al., 2021). The extreme events are exacerbating the potential for geologic hazard of expansive soils. The building standards are designed to ensure an acceptable level of safety during the life of the structure. However, many residential houses are still at risk of bearing performance issues. Although these structures have an increasingly high potential for experiencing problems, the designs can also be compromised in an effort to reduce the construction cost, in addition to other issues like poor construction and maintenance (Mostafiz et al., 2021; Vann and Houston, 2021). The building codes must always emphasize striking an appropriate balance between cost and performance, including safety and durability (Vann and Houston, 2021). The responsibility of a designer is to select the best economical design strategies, using building standards that serve satisfactory performance in its lifespan, as locally adopted and legally required minimum building code regulations govern.

With these issues at hand, the Wire Reinforcement Institute (WRI) and the Post-Tensioning Institute (PTI) have advanced existing design codes in recent decades. The WRI and PTI versions are currently well recognized in the construction industry and used by design engineers (PTI, 1980, 1996, 2004; WRI, 1981, 1996). However, in these standards, some areas lack current knowledge in implementing unsaturated soil mechanics principles and soil-structure interaction modeling. In essence, the building codes must provide the most up-to-date engineering and technical knowledge and contain all necessary design information and methodologies that are easy for design engineers to follow and implement. A building code must also offer the homebuilding

industry state-of-the-art developments that could result in more economical, durable housing with minimum construction costs.

This article presents a brief discussion about the ongoing project at the School of Civil and Environmental Engineering at Oklahoma State University with HUD-provided financial support. The project aims at developing several design modules using the principles of unsaturated soil mechanics and soil-structure interaction. The developed modules will reflect the most recent advances relating to current knowledge that will be able to predict more realistic stresses and deformations in the slab and to determine practical soil design parameters that characterize the performance of the foundation soil under applied loads, various climatic events, and other moisture boundary conditions.

Background

The problems with expansive soils are global. Expansive soils are considered the most common geologic hazard. These soils cause billions of dollars worth of destruction to building foundations and structures annually. According to the American Society of Civil Engineers, one in every four residences in the continental United States has experienced disturbances by expansive soils, with the yearly cost of damages to buildings and infrastructure surpassing \$15 billion, which is more than twice the amount of destruction that all other natural disasters cause combined, including earthquakes, hurricanes, tornadoes, and floods (Jones and Jefferson, 2012). For instance, Witherspoon (2000) indicates that Dallas, Texas, listed more than 120 foundation repair companies in the phonebook. During the same period, approximately 15 geotechnical engineering firms were conducting foundation designs for residential homes. These numbers illustrate the severity of the problem.

Residential homes will begin to show signs of distress in the form of cracks if the foundation has not been designed properly. As the walls move, the cracks begin to appear, doors start to jam, floors tilt, and structural integrity may be in jeopardy. These damages can reduce the design life of the structure, reduce its energy efficiency, and cause psychological stress to its occupants. These cracks allow for rapid infiltration of heat and cold, thus reducing energy efficiency and creating pathways for the penetration of moisture and other harmful substances. The cracks also compromise the structural integrity of the house, making it more vulnerable to damages during other disaster events, such as earthquakes. Exhibit 2 illustrates some practical cases of structure damage due to expansive soils.

Exhibit 2

Typical Damages that Expansive Soils Cause

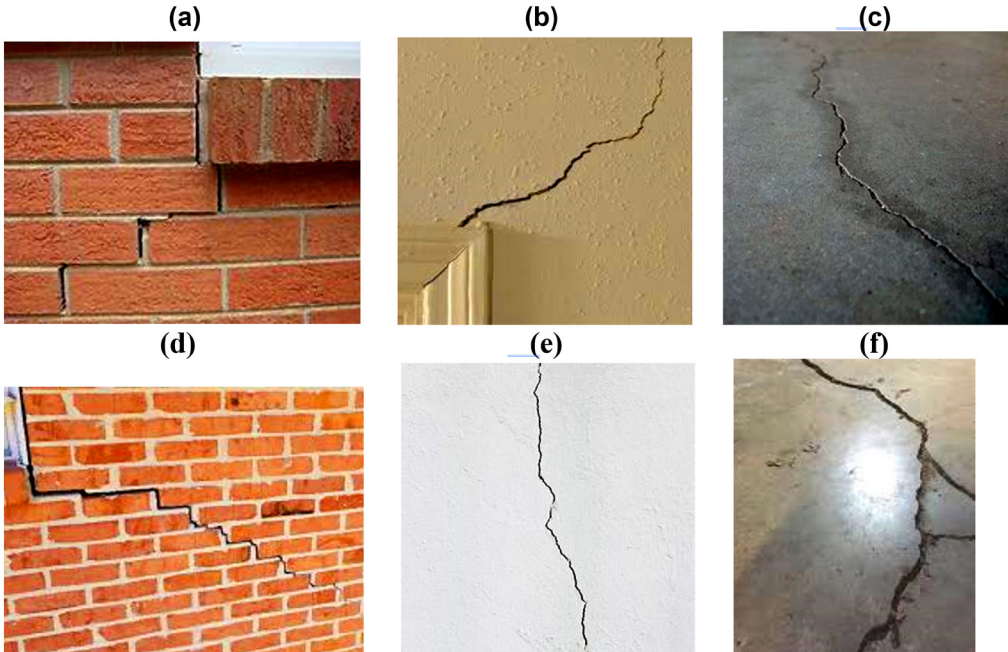

Sources: (a), (d) <https://www.jeswork.com/resources/foundation-repair/reasons-why-your-homes-foundation-is-cracking/> (b), (e) <https://www.dawsonfoundationrepair.com/best-sugar-land-foundation-repair-company/> (c) <https://garagetransformed.com/garage-floor-cracks/> (f) <https://inspectaproperty.com/blog/t/expansive-soil-what-you-should-know>

Slab-on-ground foundations became common in the early 1950s. The Building Research Advisory Board (BRAB) developed an empirical design procedure in the United States in the 1960s (BRAB, 1959, 1962, and 1968). The main objective, at that time, was simply to put the basis for designing a stiffened slab foundation on expansive soils. The Federal Housing Administration approved the BRAB procedure in 1968. In the procedure, design loads are assumed to be uniformly distributed across the slab. A support index is defined by climatic rating and plasticity index of soil. Irregular slab shapes are split into overlapping rectangular shapes and design values for maximum moment, maximum shear, and maximum deflection are calculated (BRAB, 1968). Among some engineers, the BRAB method is not considered a realistic design approach, because it does not contain a theoretical basis. Instead, a slab type is chosen among a set of empirically developed slab shapes based on the soil properties and a climatic index.

The WRI developed a method in 1981 that is very similar to the BRAB approach. In 1996, WRI updated its design methodology. WRI also considers climatic index, plasticity of soil, and soil-climate support index. The beam spacing and cantilever length are calculated from the support index, and the maximum bending moment, maximum shear, and maximum deflection are then determined (WRI, 1981, 1996).

The Wray and Lytton research served as a basis for the PTI design methodology, which has been continuously modified through the years (Wray, 1978). For structures built on expansive soils, Wray (1978) introduced the parameter edge moisture variation distance, which is based on a climatic factor called the Thornthwaite Moisture Index. The edge moisture variation parameter represents the distance from the edge of the slab inward. PTI afterward embraced this approach and introduced its first edition of the design guidelines in 1980 (PTI, 1980). In 1996, PTI published its second edition of the PTI design procedure. This edition focused on the design of both ribbed and uniform thickness foundations (PTI, 1996).

With the inclusion of several amendments during the years by the PTI's DC-10 Slab-on-Ground Committee, PTI released its third edition of design guidelines in 2004. Major adjustments were made in the assessment of geotechnical parameters (PTI, 2004). The edition includes an updated relationship between soil suction (moisture stress in soil) and the Thornthwaite Moisture Index. In the procedure, the soil analysis relies on the soil index properties. The suction compression index, a parameter that defines the magnitude of soil volume change, is calculated from both clay type and soil index properties adjusted for gradation. The unsaturated soil moisture diffusion coefficient, which determines the rate of moisture movement in the soil, is computed using the suction compression index and the slope of the soil-water characteristic curve, a relationship between the suction and soil water content. Further, the soil-water characteristic curve, which laboratory testing ideally determines, is instead derived from empirical correlations to soil index properties and gradation. Later, PTI updated the third edition with a supplement in 2008 (PTI, 2008). Whereas these parameters and concepts are heavily representing the principles of unsaturated soil mechanics, most of them are determined indirectly through some other factors and experience.

In 2019, PTI published the latest version of the design guidelines named "PTI DC10.5-19 Standard Requirements for Design and Analysis of Shallow Post-Tensioned Concrete Foundations on Expansive and Stable Soils," which is an update to the "PTI DC10.5-12 Standard Requirements for Design and Analysis of Shallow Post-Tensioned Concrete Foundations on Expansive Soils" (PTI, 2012, 2019). The newest version mainly highlights stable soils, PTI foundation types, noncompliant rectangles, shape factor recommendations, rib continuity, and edge drop moment calculation requirements (PTI, 2019).

Many states permit local authorities with jurisdiction to use or amend building codes to meet their unique requirements or, in a few exceptional cases, to build their own codes. HUD is in favor of implementing regulations that consider both regional and local interests that will minimize risks to communities in the long run. HUD has prioritized funding for the invention, adoption, and use of the latest and most robust building codes to guarantee that buildings constructed within an area can survive any potential future threats.

Shortcomings of Current Design Methods

Design methods currently used (that is, PTI, WRI, BRAB, and others) have significant shortcomings for structural analysis of slabs and do not possess a rational approach for establishing and modeling deformed ground surfaces due to swelling and shrinking of soils. The frequently used PTI method and some other methods assume an overlapping approach for residential house slabs that are not square or rectangular in shape, as exhibit 3 depicts. In other words, the methods simply cannot handle a nonrectangular shape slab for structural analyses to obtain deformations,

moments, and shear forces. The overlapping rectangle approach is simply not realistic and misses stress concentrations at critical locations in the slab due to the nonrectangular nature of the slab geometry and various loading and boundary conditions. Studies show that current methods result in sharp and discontinuous stresses over a very short distance in the slab that cannot be explained (Bulut and Lytton, 2002). The current procedures also make unrealistic assumptions by assigning only uniform foundation soil parameters around the perimeter of the slab, as well as uniform loading patterns, as exhibit 4 shows. A complete edge lift or edge drop case is considered to produce the worst-case scenario for design; however, whether the combination of the edge lift and edge drop would generate other critical stress concentration areas is unknown.

Exhibit 3

An L-Shaped Slab with Stiffening Beams (Left) and Overlapping Rectangles Assumption for Structural Analysis (Right)

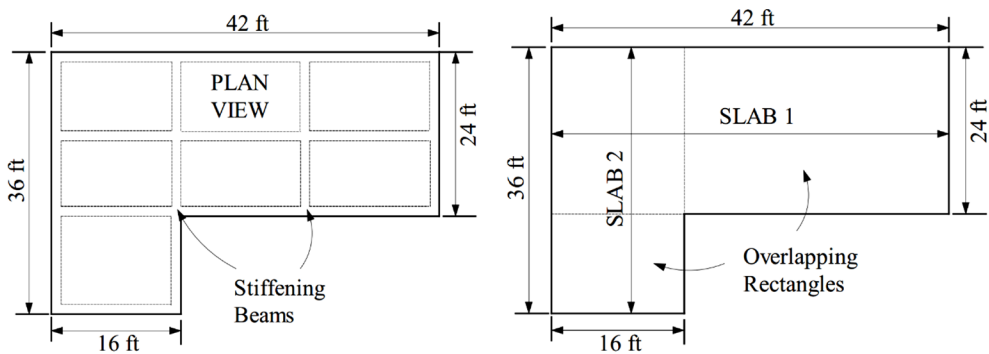

Source: Bulut, 2001

Exhibit 4

Typical Worst-Case Conditions for Design (Left) and Uniform Foundation Soil Parameters Around the Perimeter of the Slab and Uniform Loading Condition for Design

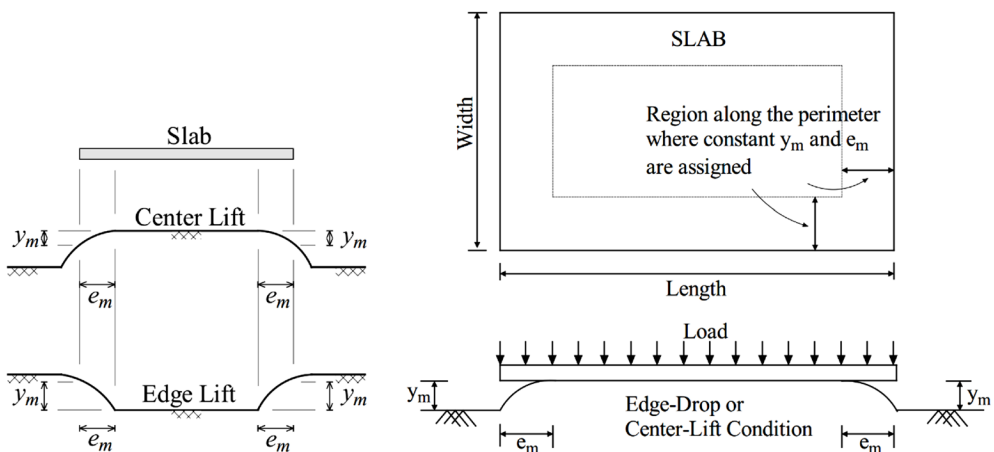

Source: Bulut, 2001

No cases of partial or combined loadings can be considered. Such approaches may not describe accurate service environments. With these limitations, it is not possible to consider various foundation boundary and slab loading conditions for an optimum (that is, resilient and sustainable) design. The current design methods have been around for a very long time, but a systematic study of the performance of distressed foundations in different geographical areas has not checked and validated the methods. As the professionals working in this field already know, these foundations have been underperforming in many different situations and have been causing billions of dollars each year for consumers to fix their homes due to poor foundation performance on expansive soils (FEMA, 1982; Jones and Jefferson, 2012).

Analysis of Slab and Expansive Soil Foundation

Current building codes are deficient, with respect to the structural analysis of slab-on-ground foundations on expansive soils, due to the overlapping slab rectangles assumptions. Improvement is needed in structural analysis of the slab for predicting deformations, moments, and shear forces in the slab. Similarly, a need exists for practical prediction of foundation soil design parameters in response to variations in climatic boundary conditions. It is equally, and probably more, important to have a realistic yet practical model that results in a rational expansive soil-foundation slab interaction interface. This study focuses on the problem for developing a rational soil structure interaction approach that can be used in modeling (or coupling) the slab with expansive soil foundation in a realistic and practical manner.

One objective of this study is to use the unsaturated soil mechanics principles applied to expansive soils for determining and assigning more rational, yet practical, soil and moisture boundary condition parameters for analysis and design. The most widely used PTI design guide uses two parameters (for example, e_m and y_m), representing the behavior of the expansive soils under climatic boundary conditions. Other design guides (for example, BRAB and WRI) also use similar parameters in their codes. The y_m parameter depends on the suction compression index (a potential volume change indicator) that is a function of the type of soil and its clay content. This value is different when the soil is swelling compared with when it is shrinking. The current tables and figures in the PTI method listing this index need to be critically evaluated. Those numbers were derived indirectly from soil index properties. A more practical and realistic approach needs to be provided in obtaining and determining these indices. The evaluation will be based on the existing and currently used data in the PTI manual that are available in the literature and the U.S. Soil Survey Conservation Services database for the United States (USDA-Natural Resources Conservation Service). The current PTI design guide uses one figure as a mineral classification chart and six figures representing six zones for the suction-compression index, γ_h . The extraction of γ_h from these figures is tedious and prone to user error. Exhibit 5 depicts only two figures, one for swelling and one for shrinkage condition. This study used a machine learning (that is, artificial intelligence) technique to construct the figures in exhibit 5. The soil index properties (liquid limit, plasticity index, clay, and silt fractions) were extracted from the U.S. Soil Survey Conservation Services database for predicting γ_h values using the machine learning method. A comparison is shown between γ_h values predicted by the model and the PTI method in exhibit 5.

Exhibit 5

A Comparison of Suction-Compression Index (γ_h) for Swelling and Shrinkage Condition Between Post-Tensioning Institute (PTI) Method and Model

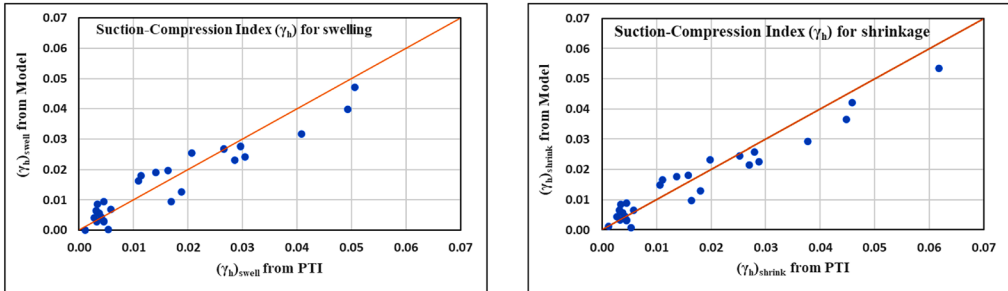

Source: Authors' research

The e_m parameter depends on the unsaturated soil moisture diffusion coefficient, which must be carefully considered. Exhibit 6(a) depicts a suction hysteresis curve for drying and wetting processes for predicting drying and wetting unsaturated soil diffusion coefficient measurements (Mabirizi and Bulut, 2010). It is well known that soils exhibit hysteresis during wetting and drying, and thus the corresponding diffusion coefficients must be used for predicting moisture movement in unsaturated expansive soils and edge moisture variation. In this study, a model was developed using the weighted average of modified unsaturated diffusion coefficient (α') and soil index properties (liquid limit, plasticity index, clay, and silt fractions) from the U.S. Soil Survey Conservation Services database for predicting edge moisture variation distance (e_m) for drying and wetting processes. Exhibit 7 shows the correlation between the PTI method and the model developed in this study. The graph for shrinkage in exhibit 7 is based on data at larger values of e_m due to limited number of datapoints.

Exhibit 6

(a) Hysteresis in Unsaturated Diffusivity Coefficient and (b) Suction Envelope Prediction Using a Single Suction Measurement Based on Modified Mitchell (1979) Model

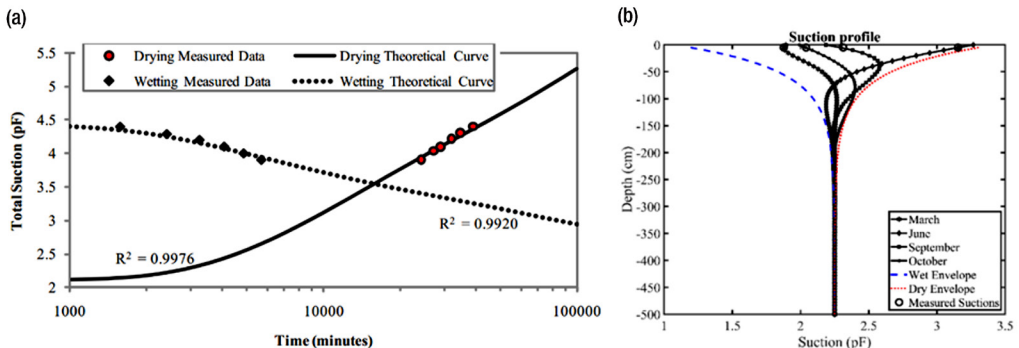

Sources: (a) Mabirizi and Bulut, 2010; (b) Javid and Bulut, 2019

Exhibit 7

A Comparison of Edge Moisture Variation Distance e_m for Swelling and Shrinkage Condition Between Post-Tensioning Institute (PTI) Method and Model

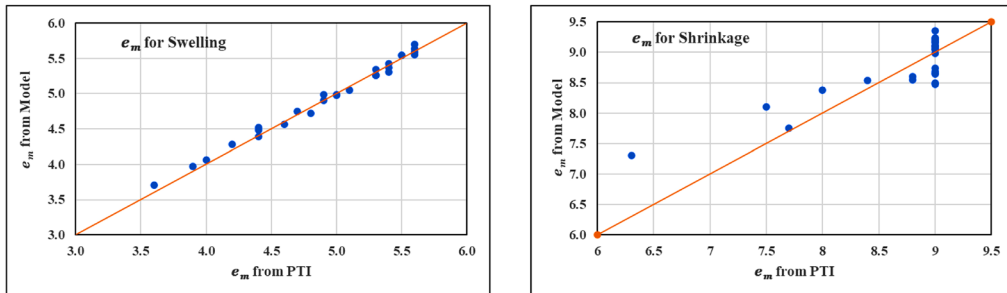

Source: Authors' research

Soil suction profile given in exhibit 6(b) and the equilibrium suction contour map depicted in exhibit 8 are needed for predicting both the differential soil movement, y_m , for swelling and shrinkage (using γ_h from exhibit 5) and the edge moisture variation distance, e_m , for swelling and shrinkage (using exhibit 7). Exhibit 6(b) shows a suction profile envelope based on the modified Mitchell model (Mitchell, 1979). To make such predictions, only one suction measurement is sufficient. Exhibit 8 demonstrates the equilibrium suction contour lines for the state of Oklahoma. These maps are generated using the modified Mitchell (1979) model for suction variation with depth and time, and actual climate data were obtained from Oklahoma Mesonet weather stations. This model, developed by Javid and Bulut (2019), can be used to create similar maps for regions with the expansive soil problems across the United States. For instance, the current PTI method uses a simple chart developed by Russam and Coleman (1961) that utilizes data from different parts of the world. Therefore, the curve may not represent site-specific equilibrium suctions.

Exhibit 8

Contour Maps of Equilibrium Suction for Oklahoma Based on Modified Mitchell (1979) Model and Actual Climate Data from Oklahoma Mesonet Weather Stations

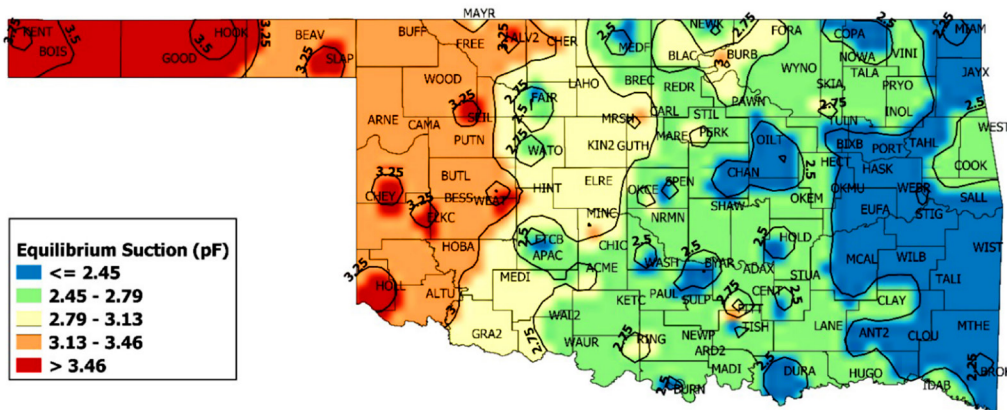

Source: Javid and Bulut, 2019

Slab-Foundation Soil Interaction

It is important that a more realistic soil-structure interface exists for understanding the behavior of slabs on expansive soil foundations. Although the BRAB and WRI design codes do not have such interaction features, the PTI method has an interface model based on the Elastic half space foundation model (that is, elastic foundation). The interface model must be based on the entire slab shape, not the overlapping slabs assumption used in the PTI method, to capture the true behavior of the coupled slab and expansive soil foundation. Such an interface would probably be achieved through finite element modeling, which can handle various slab shapes. This study aims at setting an interface algorithm module to accommodate two foundation models, such as the elastic half space and Winkler models. The Winkler model considers vertical, independent, closely spaced elastic springs generating only vertical reaction. In other words, the area directly underneath the applied load experiences deformation, whereas displacements beyond the loaded area are zero. The elastic half space soil foundation model is considered more realistic, simulating the elastic behavior of the soil in the field. In this approach, the force applied at that point, in addition to the forces adjacent to that area, influence deflection at any point.

Verification of Developed Modules with Commercially Available Software

Two commercially available software packages, PTISlab 3.5 and CORD, are used to test the soil-structure interface module proposed in this study. The PTISlab 3.5 code is widely used in the United States, and the CORD code is widely used in Australia. Both codes are quite similar and use similar assumptions in their analysis of slabs on expansive soil foundations. The comparison is accomplished by running the commercial codes and the module developed in this study, using the same input parameters (that is, applied load and soil design parameters). Currently, commercially available software (that is, PTISlab 3.5 and CORD) cannot provide the required information for rational, practical, and theoretical-based design of residential house slab foundations due to the major assumptions mentioned previously. Each computer program has its own deficiency in addressing all the needed parameters for analysis and design. A one-to-one comparison will not be possible, because the existing computer programs have their own limitations in handling various e_m and y_m values and other boundary conditions.

Two example problems in the second edition of the PTI design manual were used for the comparison study. Exhibit 9 lists soil design parameters (e_m and y_m) for both example problems. The slab dimensions for both examples are in the left panel of exhibit 3.

Exhibit 9

Soil Design Parameters (e_m and y_m)

Example 1			Example 2		
	Center Lift	Edge Lift		Center Lift	Edge Lift
y_m (inch)	3.61	0.75	y_m (inch)	0.90	0.706
e_m (feet)	5.5	2.5	e_m (feet)	4.5	5.5

Source: Authors' research

It must be noted that both PTISlab 3.5 and CORD analyze only a rectangle in the given L-shaped slab. However, the module SLAB computer program developed in this study handles the whole L-shaped slab. In example 1 of exhibit 9, for the 42-by-24-foot rectangle slab for PTISlab 3.5 and CORD and the whole slab for the SLAB program for the center lift analysis, the moments and shear forces in long and short directions are relatively comparable (not large variations from each other). However, in the edge lift analysis, CORD underpredicts the moments and shear forces in long and short directions by significant margins, relative to the results the PTISlab 3.5 gives. On the other hand, values by the PTISlab 3.5 are significantly less than the values the SLAB gives. In all other rectangular and L-shaped slabs in examples 1 and 2, trends of the results are similar.

These results indicate that, for the edge lift cases, the SLAB program gives conservative values relative to PTISlab 3.5 and CORD. This result is probably because the SLAB module can analyze the whole L-shaped slab and, therefore, can capture stress concentration points, like the reentrant corner.

Conclusions

This article outlines the need for improving the current method for analysis and design of slab foundations on expansive soils under changing climate conditions. It is important that modern houses are sustainable, resilient, energy-efficient, and affordable. The current methods that major building codes have adopted for foundation design have significant shortcomings that are not realistic and rational. These codes have major deficiencies by assuming overlapping slabs that are not able to handle various loading conditions and not able to accommodate various soil foundation models (Bulut and Lytton, 2002). This work provides an analytical approach, several modules, and computer code algorithms that engineers and researchers can use in improving the current codes for designing foundations to withstand natural hazards that expansive soils under changing climate conditions cause.

Future Research Needs

A residential house slab can be instrumented with moisture, temperature, and displacement sensors over an entire weather cycle to validate the models developed in this study, in terms of capturing actual movement of the slab vs. the model predictions.

Acknowledgments

The authors gratefully acknowledge the financial support that HUD provided for this research under grant number H-21692 CA. Furthermore, we thank Mike Blanford for managing and coordinating this work on HUD's behalf. Finally, the authors thank the editors and two referees for helpful comments.

Authors

Nafisa Tabassum is a graduate student in the School of Civil and Environmental Engineering at Oklahoma State University. Rifat Bulut is a professor in the School of Civil and Environmental Engineering at Oklahoma State University.

References

- Building Research Advisory Board (BRAB). 1968. "National Research Council Criteria for Selection and Design of Residential Slabs-on-Ground." U. S. National Academy of Sciences Publication 1571. Washington, DC: National Academies Press.
- . 1962. "National Research Council-Design Criteria for Residential Slabs-on-Ground." U.S. National Academy of Sciences Publication 1077. Washington, DC: National Academies Press.
- . 1959. "National Research Council-Design Criteria for Residential Slabs-on-Ground." U.S. National Academy of Sciences Publication 657. Washington, DC: National Academies Press.
- Bulut, Rifat. 2001. "Finite Element Method Analysis of Slabs on Elastic Half Space Expansive Soil Foundations." Ph.D. diss., Department of Civil Engineering, Texas A&M University.
- Bulut, Rifat, and Robert L. Lytton. 2002. "Slab-on-Ground—A Finite Element Method Analysis." In *The Proceedings of Texas Section American Society of Civil Engineers*.
- Diaz, Delavane, and Frances Moore. 2017. "Quantifying the Economic Risks of Climate Change," *Nature Climate Change* 7: 774–782.
- Federal Emergency Management Agency (FEMA). 1982. "Special Statistical Summary—Death, Injuries, and Property Loss by Type of Disaster 1970–1980." <https://apps.dtic.mil/sti/pdfs/ADA127645.pdf>.
- Javid, Amir H., and Rifat Bulut. 2019. "Evaluating Equilibrium Matric Suctions Under Pavement System Based on Thornthwaite Moisture Index (TMI)." *Airfield and Highway Pavements 2019: Testing and Characterization of Pavement Materials*: 511–521.
- Jones, Lee D., and Ian F. Jefferson. 2012. "Expansive Soils." In *ICE Manual of Geotechnical Engineering, Volume I*. London: Institution of Civil Engineers.
- Mabirizi, Daniel, and Rifat Bulut. 2010. "A Unified Testing Method for Measuring Unsaturated Soil Drying and Wetting Diffusion Coefficients in Laboratory," *Journal of the Transportation Research Board* 2170 (1): 109–118.
- Mitchell, Peter W. 1979. "The Structural Analysis of Footings on Expansive Soil," Kenneth W. G. Smith and Associates, Research Report No. 1. Adelaide, Australia: Webb and Son.
- Mostafiz, Rubayet B., Carol J. Friedland, Robert V. Rohli, Nazla Bushra, and Chad Held. 2021. "Property Risk Assessment for Expansive Soils in Louisiana," *Frontiers in Built Environment* 7: 1–10.
- Post-Tensioning Institute (PTI). 2019. "Standard Requirements for Design and Analysis of Shallow Post-Tensioned Concrete Foundations on Expansive and Stable Soils." Farmington Hills, MI: Post-Tensioning Institute.
- . 2012. "Standard Requirements for Design and Analysis of Shallow Post-Tensioned Concrete Foundations on Expansive Soils." Farmington Hills, MI: Post-Tensioning Institute.

- . 2008. *Design of Post-Tensioned Slabs-on-Ground, 3rd Edition with 2008 Supplement (PTI DC10.1-08)*. Phoenix: Post-Tensioning Institute.
- . 2004. *Design and Construction of Post-Tensioned Slabs-on-Ground, 3rd Edition*. Phoenix: Post-Tensioning Institute.
- . 1996. *Design and Construction of Post Tensioned Slabs-on-Ground, 2nd Edition*. Phoenix: Post-Tensioning Institute.
- . 1980. *Design and Construction of Post-Tensioned Slabs-on-Ground, 1st Edition*. Phoenix: Post-Tensioning Institute.
- Russam, Kenneth, and J. D. Coleman. 1961. "The Effect of Climatic Factors on Subgrade Moisture Conditions," *Géotechnique* 3 (1): 22–28.
- U.S. Department of Agriculture (USDA)-Natural Resources Conservation Service. "U.S. Soil Survey Conservation Services Database." <https://websoilsurvey.sc.egov.usda.gov/App/WebSoilSurvey.aspx>.
- Vann, J. D., and S. L. Houston. 2021. "Field Soil Suction Profiles for Expansive Soil," *Journal of Geotechnical and Geoenvironmental Engineering* 147 (9): 1–10.
- Wire Reinforcement Institute (WRI). 1996. *Design of Slab-on-Ground Foundations*. Findlay, OH.
- . 1981. *Design of Slab-on-Ground Foundations*. Findlay, OH.
- Witherspoon, W. T. 2000. *Residential Foundation Performance: A Study of Repaired Foundations*. Dallas: The International Association of Foundation Drilling.
- Wray, Warren K. 1978. "Development of a Design Procedure for Residential and Light Commercial Slabs-on-Ground Constructed over Expansive Soils." Ph.D. diss., Department of Civil Engineering, Texas A&M University.
- Zhang, Xiong, and Jean-Louis Briaud. 2015. "Three Dimensional Numerical Simulation of Residential Building on Shrink-Swell Soils in Response to Climatic Conditions," *International Journal for Numerical and Analytical Methods in Geomechanics* 39 (13): 1369–1409.

Refereed Papers

Refereed papers that appear in Cityscape have undergone a thorough and timely double-blind review by highly qualified referees. The managing editor reviews submitted manuscripts or outlines of proposed papers to determine their suitability for inclusion in this section. To submit a manuscript or outline, send an e-mail to cityscape@hud.gov.

Moving to Problems: Unintended Consequences of Housing Vouchers for Child Welfare-Involved Families

Patrick J. Fowler

Washington University in St. Louis

Andrew Foell

University of Illinois at Chicago

Anne K. Rufa

Michael Schoeny

Rush University

Abstract

Local child welfare services increasingly partner with public housing and homeless agencies to connect families whose housing insecurity threatens child safety with subsidized housing vouchers. The partnerships assume that access to safe and stable affordable housing offers timely support that mitigates risks for child maltreatment. Although housing vouchers appear effective at reducing material hardship and improving unit quality, it remains unclear whether vouchers facilitate moves into neighborhoods that bolster family and child development. A concern exists that voucher programs may push vulnerable families into more marginalized communities that inadvertently jeopardize child safety. Using a longitudinal randomized trial of the HUD-sponsored Family Unification Program (FUP) in Chicago, Illinois, the present study investigates neighborhood attainment of inadequately housed child welfare-involved families referred for either Housing Choice Vouchers plus housing advocacy (n = 78) or housing advocacy alone (n = 78). Results show that 2.5 years after random assignment inadequately housed child welfare-involved families referred for FUP vouchers resided in neighborhoods characterized by significantly greater concentrated disadvantage and violent crime rates than housing advocacy services alone.

Introduction

Safe, affordable, and stable housing is a significant concern for low-income families with children, especially those involved with the child welfare system. Estimates show that one-fourth of families that the child welfare system investigated for maltreatment report an inability to secure safe and stable

housing (Barth, Wildfire, and Green, 2006; Fowler et al., 2013). Child welfare-involved families who report concerns of inadequate housing routinely identify risks of family homelessness as a primary concern, jeopardizing out-of-home placement for children and disrupting family reunification for separated families (Fowler et al., 2013; Rog et al., 2017). A clear need exists for research on effective interventions that address multiple housing needs of child welfare-involved families.

Housing subsidies, which provide financial support to low-income families seeking affordable housing, have emerged as a promising and widely adopted intervention to assist families with children in securing housing. Voucher programs provide families with opportunities to secure stable housing by subsidizing rent, which demonstrates improvements in housing stability and quality for families (Fowler and Chavira, 2014; Fowler and Schoeny, 2017; Gubits et al., 2018; Pergamit et al., 2019). However, research is mixed on whether such programs improve neighborhood quality for families, a known risk factor for child maltreatment that may jeopardize child safety (Coulton et al., 2007; Freisthler, Merritt, and LaScala, 2006; Maguire-Jack and Font, 2017). Several studies found that voucher use leads to better quality neighborhoods for families, as measured by improvements in community-level poverty, crime, and various socioeconomic and demographic characteristics, whereas others find voucher recipients move to better neighborhoods in relatively small numbers that potentially diminish over time (DeLuca, Garboden, and Rosenblatt, 2013; Ellen, 2018; Lens, Ellen, and O'Regan, 2011; Ludwig et al., 2013; Nguyen et al., 2017; Park and Shelton, 2019; Patterson and Yoo, 2012; Sanbonmatsu et al., 2012). Moreover, voucher programs struggle to facilitate moves into safer, less impoverished neighborhoods, particularly for low-income families with children (DeLuca, Garboden, and Rosenblatt, 2013; Devine et al., 2003; Eriksen and Ross, 2013; Feins and Patterson, 2005; Newman and Schnare, 1997). For example, in a study of the 50 largest metropolitan areas, Mazzara and Knudson (2019) show that 14 percent of families used vouchers in low-poverty neighborhoods, whereas 33 percent of voucher-assisted families resided in high-poverty areas. Few voucher-assisted families (5 percent) lived in high-opportunity communities with access to high-quality schools, labor markets, and public transit.

Inadequately housed families involved in the child welfare system face unique barriers that further restrict housing choices. The inability to provide safe and stable housing threatens child separation, so families conduct housing searches under surveillance and time constraints. The heightened urgency potentially pushes families into less desirable housing in less desirable neighborhoods than they might otherwise access under less critical conditions (Fowler et al., 2018; Rufa and Fowler, 2018). An experimental evaluation of the effects of a multisite supportive housing demonstration project for families involved with child welfare found that treatment group families improved in terms of housing quality and satisfaction, but they did not improve their neighborhood environment compared with the control group. Moreover, the intervention had negligible effects on neighborhood satisfaction and reports of crime victimization (Pergamit et al., 2019). The evidence raises concerns for unintended consequences of housing interventions to keep families together.

Present Study

The present study uses a field experiment of the Family Unification Program (FUP) in Chicago, Illinois, to test the effect of housing vouchers on neighborhood attainment among child welfare-involved families at risk for family separation. The HUD-funded initiative provides Housing

Choice Vouchers to families whose inadequate housing caused an increased risk of out-of-home placement through local public housing and child welfare partnerships (Cunningham and Pergamit, 2015; Fowler and Chavira, 2014; Fowler et al., 2017; Pergamit, Cunningham, and Hanson, 2017). The trial compared families randomly assigned to FUP plus the child welfare Housing Advocacy Program (HAP) versus HAP alone (see the Housing Interventions section). In-home interviews conducted at baseline with followups at 6, 12, 18, and 30 months captured residential histories. Geocodes provided census tract rates of concentrated disadvantage, violent crime, and property crime rates over time. Models investigated changes in neighborhood trajectories before and after housing services. It was hypothesized that households referred for the FUP plus Housing Advocacy Program (FUP+HAP) would move to and remain in more disadvantaged neighborhoods after referral than households referred for HAP only, whose neighborhood disadvantage trajectories would not change during the followup period.

Methods

Study Design

A longitudinal randomized controlled trial was conducted within the Illinois Department of Children and Family Services (IDCFS)—the statewide child welfare system. Intact families residing in Chicago, whose inadequate housing threatened child separation, were randomly assigned to a referral for FUP vouchers. All families received referrals to HAP (see the Housing Interventions section). Referral for FUP occurred on a 1:1 ratio using a table of random numbers that research staff maintained. Caregivers referred for FUP were assessed at five different points in time for 2.5 years to track residential moves and family well-being. Although 20 percent of referred households experienced child separation during the followup, only 7 out of 150 caregivers were permanently separated from their children. An additional nine families had at least one child permanently removed; however, most of the children remained in their homes. Thus, the unit of analysis is the neighborhood of the original caregivers at the point of randomization.

Data collection efforts focus on gathering reliable and valid survey data on a representative sample of the 178 eligible families who the IDCFS referred for the FUP in Chicago. Randomized on a 1:1 ratio for referral to housing advocacy services or FUP plus advocacy, a sample of 150 families agreed to participate and completed a baseline interview approximately 3 months after referral to FUP. The participation represents 84.3 percent of families referred to the program. Families include 380 surveyed children aged 0 to 15 years at baseline, as well as 13 extended caregivers who took on parenting responsibilities during the study period. Children and families were interviewed at followups of 6, 12, 18, and 28 months.

Participants

Participants included surveyed child welfare-involved families eligible for the FUP. Inclusion into the study depended on (1) a child welfare caseworker referral for FUP between July 2011 and July 2013, (2) children who remained in their homes at the time of referral, (3) families who met eligibility criteria for the Housing Choice Voucher program, and (4) informed consent into the survey study. Exclusion occurred if families failed to meet these criteria or resided outside of Chicago at the time of referral for FUP.

Housing Interventions

The FUP connected child welfare-involved families whose inadequate housing threatened child out-of-home placement with permanent housing vouchers through the local public housing authority (Fowler et al., 2018; Fowler and Schoeny, 2017). Housing vouchers provided subsidies that ensured families paid no more than 30 percent of household income toward rent in units that met minimal standards of safety and quality. Households retained housing vouchers until income exceeded eligibility thresholds or families failed to follow program rules, and thus, families frequently kept vouchers long past closure of child welfare cases.

Families referred for FUP simultaneously received assistance through HAP. The child welfare-administered program typically offered case management for one to three sessions through contracted social service agencies. Advocates assessed goals and developed tailored plans to stabilize housing (Egan, 2007). Families received skills training, including housing resume building, role playing on approaching and negotiating with landlords, education on tenant responsibilities and rights, and budgeting. Advocates also assisted in housing searches; they maintained updated lists of available and affordable housing with known landlords across neighborhoods, which facilitated timely accommodations for families with little or poor housing histories. HAP offered security deposits or first-month rent and access to appliances, cookware, flatware, tables, and chairs, as needed. One-half of households received only referrals to HAP without FUP vouchers.

Procedures

Child welfare caseworker referrals identified and recruited families for the study from the IDCFS Housing and Cash Assistance Office, which provides services to families in the child welfare system identified as inadequately housed. IDCFS staff determined FUP eligibility. Families randomly assigned for FUP+HAP were connected with the Chicago Housing Authority (CHA) Housing Choice Voucher program and housing advocacy, whereas those assigned to HAP only received advocacy without a voucher. Housing advocacy was typically delivered for one to three sessions with community-based agencies contracted through the child welfare system. Program staff trained and supervised advocates, and performance-based contracting ensured that referred families received timely and minimal contacts (Egan, 2007). There was zero crossover from the HAP-only group to the voucher group.¹

Survey Methods and Measures

Caregiver Demographics. Several caregiver demographic characteristics were collected for the study. Caregiver age in years at baseline was self-reported. Caregiver gender was both self-reported and coded by interviewers. Caregivers self-reported race or ethnicity at baseline, choosing all descriptions that applied. For these analyses, caregiver race was categorized as Black, Latino,

¹ The study complied with ethical procedures involved in human subject research. DePaul University received initial institutional review board (IRB) approval, then subsequently Washington University in St. Louis, where the study oversight was transferred. Nonidentifiable data were used in analyses, thus DePaul University did not require IRB approval. Consent and, where appropriate, child assent were collected from caregivers and children for assessments they completed. All interviews were conducted using laptop computers and were checked for accuracy and completeness. Family interviews were scheduled around convenient times and locations for the family. Caregivers received \$50 for participation.

or White. Educational attainment, poverty level, number of children, child age in years, and experiences of child separation were also collected.

Housing Timelines. Families' housing timelines, including home addresses, were measured across time. A life events calendar collected housing timelines for 12 months before the baseline interview and between interviews. If families missed a followup interview, the timeline assessed housing since the most recent interview, which never exceeded 24 months. Life events calendars have been employed in large-scale and longitudinal studies, demonstrating accuracy and validity for housing and other life events (Belli, Shay, and Stafford, 2001; Freedman et al., 1988; Yoshihama and Bybee, 2011). The method also has been used extensively with highly mobile populations showing strong psychometric properties in these groups (Fowler, Toro, and Miles, 2009; McCaskill, Toro, and Wolfe, 1998).

Neighborhood Attainment. Structural indicators of neighborhood quality were obtained based on geocoded residential addresses at baseline and followup interviews. The neighborhood was defined at the level of the census tract. Three structural characteristics were measured in this study—concentrated disadvantage, violent crime, and property crime. Concentrated disadvantage was created as a linear combination of four census variables that have been previously shown to characterize neighborhood context: (1) percentage of female-headed households; (2) percentage of unemployed adults; (3) percentage of owner-occupied homes; and (4) percentage of families below the poverty level (Sampson, 2012; U.S. Census Bureau, 2014). Using data from the 2014 5-year American Community Survey for all census tracts in the United States, a principal components analysis revealed a single factor that accounted for 68.2 percent of the variance in the items. Summed percentages were then converted to z-scores across all census tracts in the United States, with higher scores indicating greater disadvantage. The composite measure of concentrated disadvantage was created as a standard score with a mean of zero and a standard deviation of one.

Crime incident data from the Chicago Police Department were obtained for the study period. For each incident, these data include the date and time of occurrence, type of crime, and the geocoded location. The Chicago Police Department uses the Illinois Uniform Crime Reporting codes to classify incidents. The Illinois Uniform Crime Reporting codes can be aggregated to FBI Uniform Crime Reporting codes. For the present analyses, two categories of crime were used as outcome measures—violent crime (murder, criminal sexual assault, robbery, and aggravated assault and battery) and property crime (burglary, larceny or theft, motor vehicle theft, and arson). Violent and property crime rates were measured as the annual incidence per 100,000 residents in the census tract, recorded by the Chicago Police Department and collected for the 2012 calendar year (U.S. Department of Justice, 2013).

Analytic Approach

An intent-to-treat analysis assessed the effect of FUP on neighborhood attainment. This study used discontinuous growth modeling to assess household shifts in neighborhood quality before and after referral for FUP+HAP versus HAP only (Singer and Willett, 2003). Discontinuous growth modeling offered advantages for answering the study research questions beyond linear growth models that would test $Y_{ij} = \pi_{0i} + \pi_{1i}(Time) + \pi_{2i}(Condition) + \pi_{3i}(Time \times Condition) + r$. Multilevel modeling

appropriately nests time within households and reliably handles sample sizes smaller than the present study (Hox and McNeish, 2018; Hoyle and Gottfredson, 2015; Maas and Hox, 2005). Discontinuous growth modeling also explicitly investigates whether a discrete event disrupts trajectories beyond the passage of time (Bliese, Adler, and Flynn, 2017; Dalal, Alaybek, and Lievens, 2020; Singer and Willett, 2003). The discontinuity approach allowed for testing the expectation that neighborhood quality trends at the time of referral for FUP+HAP would continue over time.

The dependent variables included monthly concentrated disadvantage, violent crime, and property crime rates collected from household residential address timelines that were geocoded at the census tract. Models estimated the intercept and slope of monthly neighborhood change before referral for housing services and the intercept and slope of change after referral as random effects. Time-varying covariates included *time* (centered at the month of the HAP or FUP referral) and the discontinuity (before housing services = 0, after housing services = 1). Time-invariant family-level covariates included the intervention condition (FUP+HAP = 1, HAP only = 0), as well as caregiver race or ethnicity (Latino = 1, Black = 0; White = 1, Black = 0), parent age, and household size to enhance the precision and power for testing treatment effects (Kahan et al., 2014; Zhang, Tsiatis, and Davidian, 2008).

A set of interaction terms between time, intervention condition, and discontinuity tested the primary research question. A significant effect for the condition x discontinuity two-way interaction indicates a difference by treatment condition in the change in the level of the outcome from pre- to post-intervention. A significant effect for the three-way condition x times x discontinuity interaction indicates a difference by treatment condition in the change in time slope from pre- to post-intervention. A priori comparisons tested hypothesized effects (Singer and Willett, 2003). The final model is in the following equation.

$$\begin{aligned}
 Y_{ij} = & \beta_{00} + \beta_{01}(\text{Condition})_j + \beta_{02}(\text{Latino})_j + \beta_{03}(\text{White})_j + \beta_{04}(\text{Age})_j + \beta_{05}(\text{HH Size})_j + & \text{[Combined]} \\
 & \beta_{10}(\text{Time})_{ij} + \beta_{11}(\text{Condition})_j(\text{Time})_{ij} + \beta_{20}(\text{Discontinuity})_{ij} + \\
 & \beta_{21}(\text{Condition})_j(\text{Discontinuity})_{ij} + \beta_{30}(\text{Time})_{ij}(\text{Discontinuity})_{ij} + \beta_{31}(\text{Condition})_j(\text{Time})_{ij}(\text{Discontinuity})_{ij} \\
 & + u_{0j} + u_{1j} + r_{ij} \\
 \pi_{0j} = & \beta_{00} + \beta_{01}(\text{Condition})_j + \beta_{02}(\text{Latino})_j + \beta_{03}(\text{White})_j + \beta_{04}(\text{Age})_j + \beta_{05}(\text{HH Size})_j + u_{0j} & \text{[Level 2]} \\
 \pi_{1j} = & \beta_{10} + \beta_{11}(\text{Condition})_j + u_{1j} & \text{[Level 2]} \\
 \pi_{2j} = & \beta_{20} + \beta_{21}(\text{Condition})_j & \text{[Level 2]} \\
 \pi_{3j} = & \beta_{30} + \beta_{31}(\text{Condition})_j & \text{[Level 2]}
 \end{aligned}$$

Results

Balance Testing

Exhibit 1 presents information on random assignment. Child welfare caseworkers started applications for 229 families to FUP+HAP; uncompleted applications were not referred for FUP+HAP. Randomization assigned 179 families to receive FUP+HAP (n = 89) versus HAP only (n = 88).²

Exhibit 1

Family Unification Program (FUP) Experiment Flow Diagram

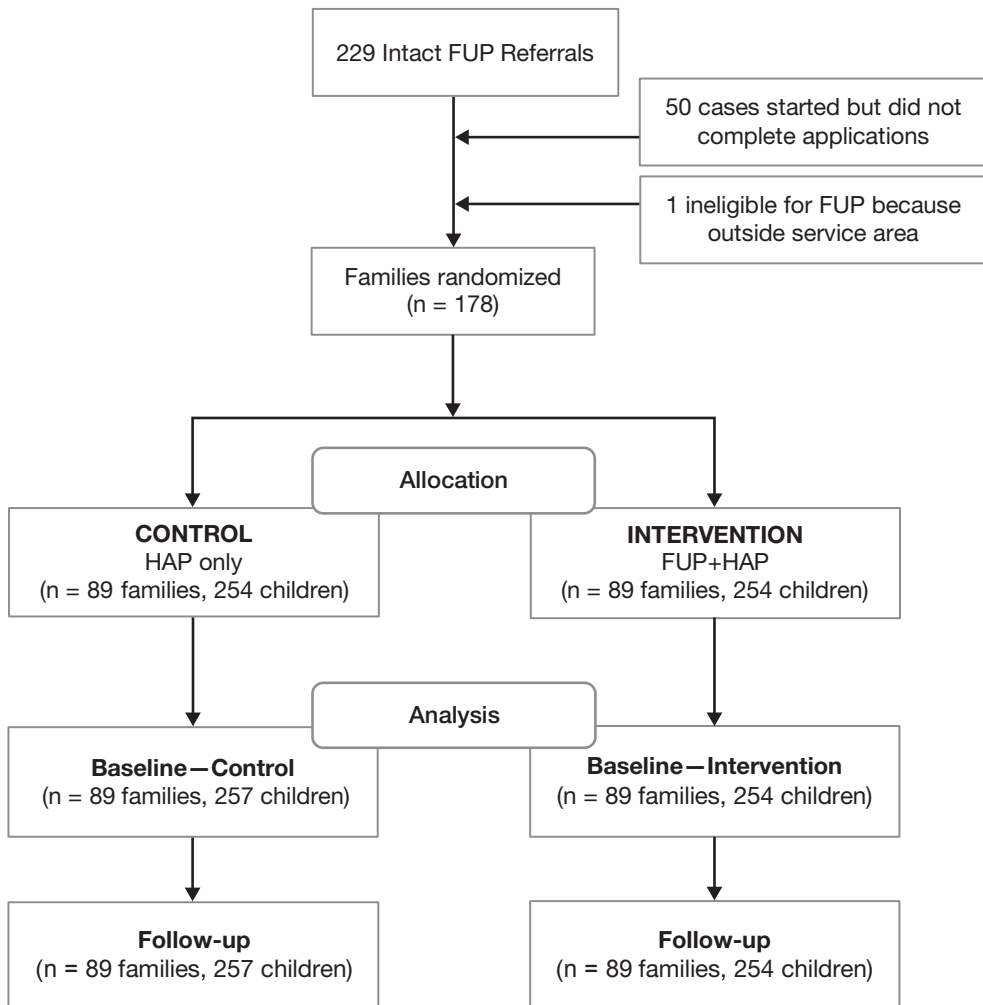

HAP = Housing Advocacy Program.

Source: Authors

² One family randomly assigned for FUP was subsequently deemed ineligible, because they lived outside of Chicago at the time of referral. Another family was ineligible for the survey, because they moved out of state by the time of recruitment. The primary reason for survey participation failure was due to research staff not being able to contact the family.

Exhibit 2 summarizes baseline surveys with 150, or 84.7 percent of the population of child welfare families referred for FUP in Chicago during the study period. The sample size provided 99 percent confidence that descriptions represented the population within plus or minus 3 percentage points. Although underpowered, no significant differences existed between surveyed (n = 150) and nonsurveyed families (n = 27) at baseline on information provided in the FUP referral. Caregivers ranged in age from 18 to 53 years and were typically in their early 30s (control mean = 31.2 years, treatment mean = 31.6 years). Caregivers were predominately female (control = 95 percent, treatment = 92 percent). Most caregivers identified as Black (control = 65 percent, treatment 68 percent), Latino (control = 20 percent, treatment = 21 percent), or White (control = 13 percent, treatment = 11 percent). Nearly all households earned less than the federal poverty level at the time of referral for housing services, and more than one-half reported incomes below 50 percent of the federal poverty level. The typical family included between two and three children under 18 years of age, with more than one-half having children under 6 years of age.

Exhibit 2

Baseline Characteristics of Homeless Families Whose Inadequate Housing Threatens Out-of-Home Placement by Housing Intervention

	FUP+HUP		HAP		
	Mean or %	Std Dev	Mean or %	Std Dev	<i>p</i>
Caregiver age	32.0	8.5	31.2	7.6	0.56
Caregiver gender (female)	92.0		94.7		0.51
Caregiver race					0.90
% Black	68.0		65.3		
% Latino	21.3		20.0		
% White	9.3		13.3		
% Other	1.3		1.3		
% High school graduate	68.0		60.0		0.31
Proportion of poverty guideline	0.47	0.57	0.49	0.58	0.86
Below 50% of poverty guideline	76.5		70.0		0.39
Number of children	2.87	1.8	2.8	1.7	0.56
Age ranges of children					1.0
% Infants	30.7		30.1		
% 3–5 years	21.9		22.8		
% 6–11 years	28.4		28.2		
% 11–15 years	19.1		18.9		
Age of children	6.2	5.1	6.1	5.1	0.83

FUP = Family Unification Program. HAP = Housing Advocacy Program. Std Dev = standard deviation.
 Source: Authors

Families recruited for the survey were evenly divided between FUP+HAP (n = 75) and HAP only (n = 75). Baseline equivalency existed across all observed characteristics. Moreover, families offered FUP+HAP and HAP only lived in similar neighborhoods with concentrated disadvantage, violent crime, and property crime for 12 months prior to referral and at the time of referral, as exhibit 3 reports.

Exhibit 3

Neighborhood Outcomes and Percent Change Compared at the Time of Referral with the Family Unification Program Plus Housing Advocacy Program (FUP+HAP, n = 75) or HAP Only (n = 75), Chicago, Illinois

	FUP+HUP				HAP Only			
	n	Mean	Std Dev	% Change	n	Mean	Std Dev	% Change
Concentrated Disadvantage (z-score)								
12 months prior	69	1.36	0.82	-0.02	71	1.57	0.93	0.01
Baseline	75	1.39	0.87	0.00	74	1.55	0.93	0.00
6 months post	68	1.5	0.79	0.08	66	1.56	0.93	0.01
12 months post	69	1.61	0.68	0.16	60	1.42	0.94	-0.08
18 months post	65	1.58	0.66	0.14	55	1.53	0.89	-0.01
30 months post	55	1.48	0.70	0.06	48	1.4	0.86	-0.10
Violent Crime Rate (per 100,000)								
1 month prior	64	1139	790.00	0.12	66	1013	676.00	0.00
Baseline	73	1021	677.00	0.00	73	1014	660.00	0.00
6 months post	66	1067	627.00	0.05	64	1119	762.00	0.10
12 months post	68	1146	647.00	0.12	56	1002	657.00	-0.01
18 months post	64	1178	636.00	0.15	50	1099	703.00	0.08
30 months post	51	1107	604.00	0.08	44	1076	665.00	0.06
Property Crime Rate (per 100,000)								
12 months prior	64	5163	3891.00	-0.03	66	4562	2639.00	-0.02
Baseline	73	5297	4109.00	0.00	73	4670	2709.00	0.00
6 months post	66	5032	3442.00	-0.05	64	4696	2272.00	0.01
12 months post	68	4899	1975.00	-0.08	56	4406	2155.00	-0.06
18 months post	64	4954	1862.00	-0.06	50	4399	2162.00	-0.06
30 months post	51	4758	2133.00	-0.10	44	4618	2173.00	-0.01

Std Dev = standard deviation.

Notes: Caregivers retrospectively reported residential addresses at each interview. Geocodes captured block group at the time of observation when mappable. Percent change represents the degree households lived in less (negative) versus more (positive) neighborhoods compared with baseline. No treatment differences existed in pre-intervention neighborhoods.

Source: Authors

Differential Attrition Testing

No evidence existed for differential attrition by treatment condition. At least one followup survey occurred with 133, or 88.7 percent, of surveyed families. Analysis of covariance probed differential attrition by testing whether treatment condition, attrition, or the interaction of treatment by family characteristics predicted baseline family characteristics. No significant differences emerged.

Family Unification Program Implementation and Uptake

Exhibit 4 visually displays the FUP implementation and families' progression toward housing voucher receipt. Child welfare caseworkers submitted an initial application for FUP to the IDCFS Housing and Cash Assistance Office. The application process took, on average, 30.74 days to complete (standard deviation = 35.033, minimum = 2.004, maximum = 153 days). No families

were explicitly denied referral for FUP during the study period; however, child welfare caseworkers failed to follow up on applications. Although IDCFS did not record the frequency, it was estimated that for every four applications, one did not fully complete the process (that is, approximately 230 families started applications). One family received a Housing Choice Voucher from the CHA waitlist before randomization, which referred them to FUP.

Exhibit 4

Family Unification Program (FUP) Implementation in Chicago, Illinois

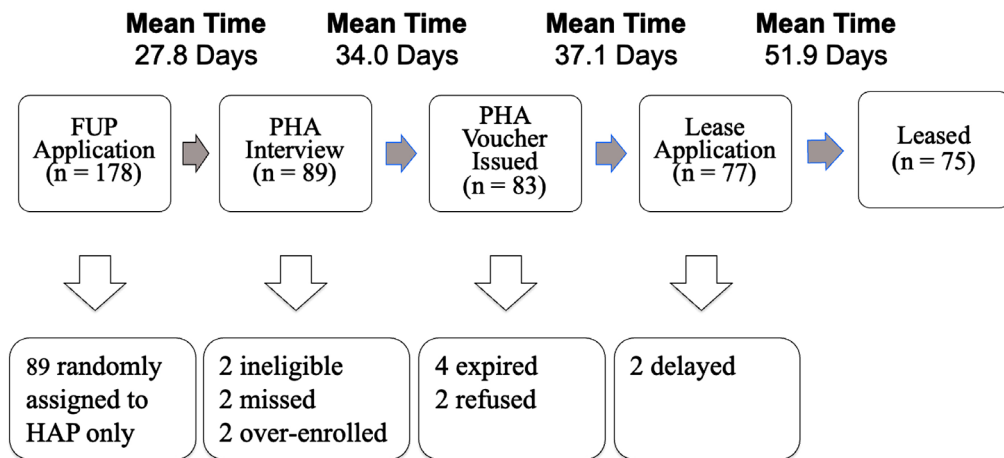

HAP = Housing Advocacy Program. PHA = public housing authority.
 Source: Authors

Families randomized for FUP were referred to the CHA. It took 27.802 days (standard deviation = 19.222, minimum = 4, maximum = 104) for CHA to schedule and complete an eligibility interview, and all eligible families received an interview. Most families (93.3 percent) were declared eligible for vouchers by CHA; two out of the six families were deemed ineligible for housing choice vouchers, and two missed appointments. In addition, two families did not receive vouchers due to over enrollment; CHA requested referrals and subsequently realized the number of families in the program exceeded the number of FUP vouchers HUD had provided.

The housing authority issued vouchers for families to begin housing searches approximately 30 days after interviews (mean = 33.961 days, standard deviation = 28.974, minimum = 0, maximum = 157). Of families issued vouchers, 78 (93.98 percent) found housing and submitted a request for tenancy approval to CHA after 37.142 days (standard deviation = 34.411, minimum = 0, maximum = 183). Among families who did not find housing, four exceeded the 90-day limit to secure housing, and CHA denied time extensions; one refused the voucher because the amount was too low; and one reported immigration-status concerns. Housing inspections and approval of leases required an additional 51.913 days (standard deviation = 32.564, minimum = 0, maximum = 157), on average, before families leased up. Seven families continued to wait to lease up due to delays in landlord negotiations with CHA; five of these families were eventually housed, whereas the status of two cases remained unclear.

Overall, 84.3 percent (75 divided by 89) of referred families received FUP vouchers. It required 146.26 days (standard deviation = 64.754, minimum = 48, maximum = 350) from IDCFS referral to lease up with vouchers. Families who did not receive vouchers (n = 14) experienced significantly longer delays between IDCFS referral and CHA interviews—mean = 41.781 versus mean = 25.152 days, $t(1, 86) = 3.114$, $p < .03$ —compared with referred families who received vouchers (n = 75). Families did not differ on the time it took IDCFS caseworkers to complete FUP applications. In addition, IDCFS time to complete applications did not significantly correlate with any other phase of voucher access, and delays in one CHA phase were not related to delays in other phases. The absence of relationships suggested no systematic barriers existed for particular families to receive vouchers.

Family Unification Program Effect on Neighborhood Attainment

Exhibit 3 summarizes neighborhood attainment across the study period by treatment condition. Calculated as a percentage change from baseline, scores represent the mean differences between baseline and pre or post-referral neighborhood characteristics ($D = (T_i - \text{Baseline})/[\text{Baseline}]$). Negative values indicate better neighborhoods, and positive values indicate worse neighborhoods than baseline. Unadjusted results suggested families referred for FUP+HAP experienced smaller improvements of concentrated disadvantage and violent crime at 28 months of followup and larger improvements for property crime. To investigate household-level change and maximize statistical power, growth models tested the significance of changes.

Coefficients from the discontinuous growth models are presented in exhibit 5. Across all models, Black families were more likely to reside in neighborhoods characterized by higher levels of concentrated disadvantage, violent crime, and property crime than White and Latino families. Other family characteristics, including parent age and household size, were unrelated to neighborhood quality characteristics. Time, discontinuity, and the time x discontinuity interaction predicted concentrated disadvantage and property crime such that households, on average, experienced more disadvantage and property crime, especially after randomization. Crime rates did not significantly change over time. A sensitivity analysis that excluded families experiencing child separation produced similar results as the main findings.

Exhibit 5

Intervention Effects on Neighborhood Quality Changes Between Family Unification Program Plus Housing Advocacy Program (FUP+HAP) and Housing Advocacy Program (HAP) Only Families

Parameter	Concentrated Disadvantage		Violent Crime Rate			Property Crime Rate		
	Estimate (Std Error)	t	Estimate (Std Error)	t	Estimate (Std Error)	t		
Intercept	1.68 (0.24)	7.02***	1322.47 (212.59)	6.22***	6009.99 (929.41)	6.47***		
^a Race and Ethnicity								
Latino	-0.74 (0.11)	-6.42***	-737.08 (101.90)	-7.23***	-2396.22 (445.36)	-5.38***		
White	-1.02 (0.15)	-6.80***	-815.05 (133.56)	-6.10***	-2529.02 (583.23)	-4.34***		
Parent age	0.00 (0.01)	0.48	0.25 (5.20)	0.05	-1.39 (22.70)	-0.06		
Household size	0.03 (0.02)	1.25	-7.63 (19.76)	-0.39	-117.64 (86.29)	-1.36		
Time (months)	0.01 (0.00)	3.91***	0.56 (1.89)	0.30	-13.36 (9.67)	-1.38		
^b FUP+HAP	-0.21 (0.09)	-2.25*	46.35 (83.51)	0.56	758.34 (369.48)	2.05*		
^c Discontinuity	-0.06 (0.03)	-2.15*	4.30 (18.39)	0.23	-18.34 (92.91)	-0.20		
Time x FUP	0.00 (0.00)	-0.60	-0.66 (2.67)	-0.25	25.75 (13.70)	1.88		
Time x discontinuity	-0.02 (0.00)	-10.66***	0.99 (1.12)	0.89	17.75 (5.63)	3.15**		
FUP x discontinuity	0.12 (0.04)	3.45***	-6.73 (25.62)	-0.26	-176.71 (129.43)	-1.37		
Time x FUP x discontinuity	0.01 (0.00)	5.51***	4.71 (1.51)	3.13**	-26.43 (7.61)	-3.48***		

Std Err = standard error.

Notes: * $p < .05$, ** $p < .01$, *** $p < .001$; ^a0 = Black; ^b0 = HAP only; ^cDiscontinuity represents a time-varying binary indicator that indicates whether the outcome is observed before (0) or after (1) randomization to treatment condition.

Source: Authors

The interactions between time, treatment condition, and discontinuity, plotted in exhibit 6, primarily tested the effect of FUP+HAP on neighborhood outcomes. For concentrated disadvantage (panel A), families referred for FUP+HAP moved to more disadvantaged neighborhoods ($p < .01$) after randomization compared with households referred for HAP only that moved to significantly less disadvantaged areas ($p < .05$). In addition, neighborhoods with concentrated disadvantage for families in the HAP-only condition continued to improve over time ($p < .001$), although it did not change for families in the FUP+HAP condition.

Exhibit 6

Plots of Neighborhood Attainment by Treatment Condition and Time Interactions

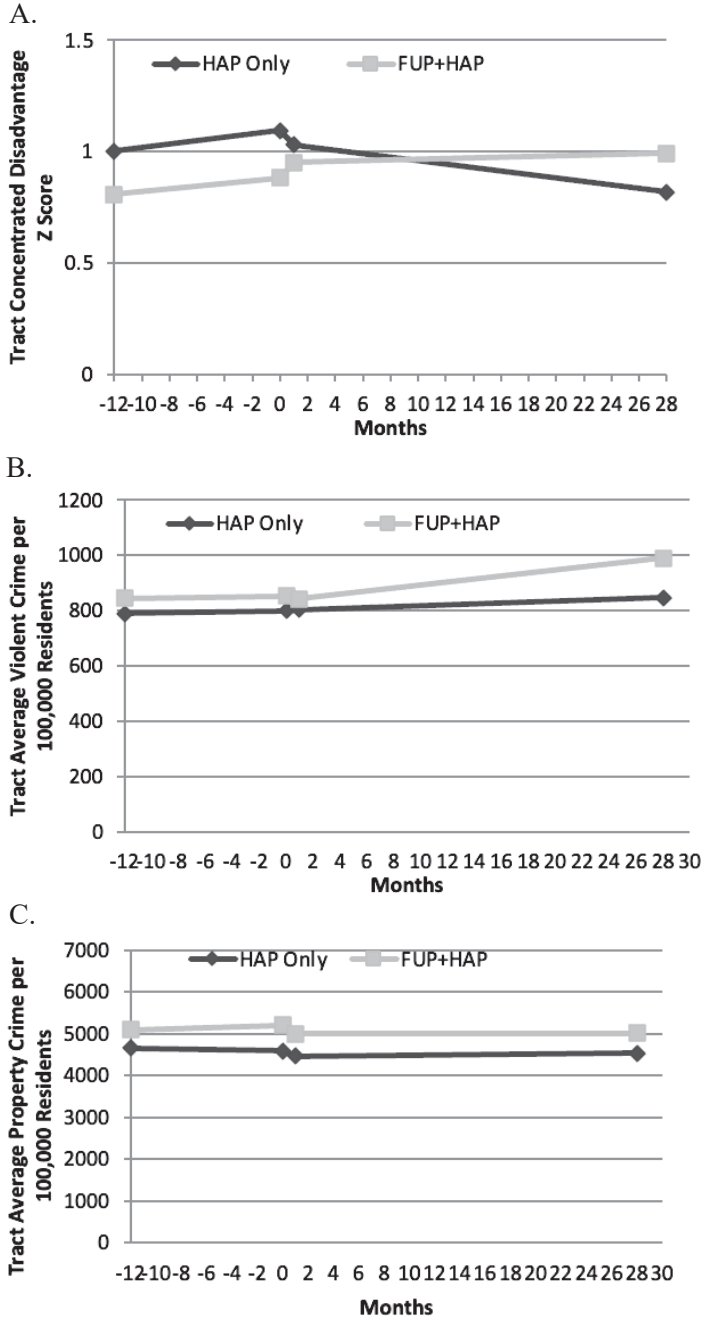

FUP+HAP = Family Unification Program plus Housing Advocacy Program. HAP = Housing Advocacy Program.

Note: FUP+HAP families moved to neighborhoods characterized by higher concentrated disadvantage (panel A) and violent crime (panel B) compared with HAP-only families.

Source: Authors

Significant effects of FUP also existed for crime rates. Households in both treatment conditions reported living in violent neighborhoods before randomization; the average rate of violent crime of 800 incidents and property crime of 5,000 incidents per 100,000 residents doubled the national averages of 386 violent crimes and 2,450 per 100,000 residents (U.S. Department of Justice, 2013). Households referred for FUP+HAP moved to neighborhoods with higher violent ($p < .01$) and property ($p < .05$) crime rates after randomization. In contrast, the families in the HAP-only condition exhibited no change in violence or property crime, and none of the individual slopes nor the differences between pre- and post-randomization slopes were significantly different.

Discussion

This study examines the effect of FUP—a HUD-sponsored partnership between local child welfare and public housing agencies—on neighborhood attainment in Chicago. This study highlights potential trade-offs between housing and neighborhood attainment that families with children balance when seeking safe and stable housing (DeLuca, Wood, and Rosenblatt, 2019; Rosenblatt and DeLuca, 2012). Findings show evidence of an unintended consequence of housing voucher receipt for child welfare-involved families' mobility into significantly more disadvantaged and dangerous neighborhoods. Although housing subsidy programs generally expand housing choice and neighborhood attainment for families, the findings suggest that such programs may be less effective at moving child welfare-involved families into neighborhoods that provide resources and opportunities to promote positive family functioning and stability (Lens, Ellen, and O'Regan, 2011; Patterson and Yoo, 2012). The outcome is particularly concerning for Black families, who often reside in the most disadvantaged communities and face multiple structural barriers in the housing market that further restrict housing choices.

Qualitative work with a representative subsample of caregivers in the study helps clarify the unintended consequences on neighborhood attainment. Child welfare-involved families feel pushed to secure stable housing as quickly as possible to avoid homelessness and family separation (Rufa and Fowler, 2018). Families referred for vouchers lose the subsidy if unable to find a willing landlord within 90 days, and units that accept vouchers disproportionately fall within high-poverty, low-opportunity neighborhoods (Cunningham et al., 2018; Mazzara and Knudsen, 2019). Although families using housing assistance want to move to better neighborhoods, they may trade off neighborhood quality for voucher acceptance or (unmeasured) housing quality (DeLuca, Wood, and Rosenblatt, 2019; Rosenblatt and DeLuca, 2012). In addition, landlords with properties in high-poverty neighborhoods may actively recruit families with vouchers to secure higher rents than could be sought on the market (Rosen, 2014). These barriers, combined with the immediacy of moving, mean that families are often stuck with limited options and must move to where vouchers are more readily accepted. Child welfare-involved families navigate tight low-income rental markets under the heightened stress and surveillance associated with involvement in multiple systems with immense power over the lives of their children. These factors create the “perfect storm” in finding and securing quality affordable housing (D'Andrade et al., 2017; Fowler et al., 2018).

Implications

Improving the housing experiences of families involved with the child welfare system requires the provision of flexible programs and services that are effectively coordinated among partners across

systems (D'Andrade et al., 2017; Winters et al., 2020). Housing advocates are at the forefront of this critical work. Their role must be expanded alongside efforts to address the systemic and structural barriers confronting low-income families in the housing market. Housing advocates must ensure that families are adequately equipped with knowledge about their housing options and housing rights while also advocating for policies to incorporate additional accountability measures, particularly for landlords, to ensure that families can move into housing in neighborhoods that support, rather than undermine, well-being.

The findings are especially relevant as families navigate monumental disruptions to the affordable housing market following COVID. Within this context, nearly \$50 billion federal dollars have been allocated to deliver time-limited emergency rental assistance programs and services to homeless and housing-insecure families, including \$5 billion in Emergency Housing Vouchers. The pandemic has also generated a unique social and economic context for low-income families characterized by wage cuts, job loss, increased stress, and social isolation—all factors associated with child maltreatment and family stability. Emergency rental assistance programs must consider ways to connect families with information and resources necessary for secure housing. This connection includes ensuring that families have updated and accurate housing lists, that programs offer adequate housing counseling and financial assistance to move (for example, deposit and rent assistance, moving assistance, and so on), and that local housing authorities and community organizations have strong partnerships with landlords and leasing agencies (Bergman et al., 2019; DeLuca, Garboden, and Rosenblatt, 2013). Further attention must also be placed on program policies and practices that limit participation, including lengthy and unpredictable waitlists for families and inefficient bureaucratic procedures for landlords (Galvez and Oppenheimer, 2020).

Two recent studies provide promise and caution for such interventions. In their assessment of an experimental Housing Choice Voucher program in Seattle, Washington, *Creating Moves to Opportunity*, Bergman et al. (2019) found that 14 percent of control group voucher-only families moved to high-opportunity neighborhoods compared with 54 percent of *Creating Moves to Opportunity* families who received additional search assistance, landlord engagement, and short-term financial assistance. Their results suggest that housing voucher programs devoid of further assistance to help voucher holders in the search and leasing process are unlikely to result in significant gains in neighborhood quality (Bergman et al., 2019). It is yet unclear whether these programs work similarly across contexts. For example, in Chicago, the offer of a \$500 moving grant and housing mobility counseling did not significantly improve family moves to higher opportunity neighborhoods (Schwartz, Mihaly, and Gala, 2017).

Child welfare-involved families in the housing voucher program report experiences of limited power or control over housing choices, as seen through the push-pull cycle and additional constraints that not only affect housing decisions but also discourage families from moving to higher opportunity neighborhoods, should they want to do so (Rufa and Fowler, 2018). These constraints mean that securing high-quality, affordable housing in communities that support family needs is challenging (Rufa and Fowler, 2018). Future research assessing the added value or unintended consequences of housing vouchers combined with housing assistance programs is needed, particularly across contexts with different housing market dynamics. In addition, studies

need to illuminate appropriate additive interventions that address the housing-neighborhood quality dilemma for low-income families with children.

Limitations

The findings of this study must be considered alongside the limitations. The single-city study set in Chicago may not generalize more broadly to other communities implementing FUP that vary in low-income rental market characteristics and family supports. Less poverty and greater tenant protections could facilitate connections with safe and secure housing. The study also relies on census tract estimates of disadvantage and crime at the midpoint of the study followup period, which may disguise more local and temporal neighborhood dynamics. Another limitation concerns the accurate recall of locations among highly mobile families. Although the calendar interview includes prompts for promoting recall, frequent moves interfere with the ability to capture all transitions, and thus, some neighborhood identification may be unreliable. Despite a small sample size and a single site, study findings inform child welfare and public housing responses to family homelessness. Ensuring that households receive adequate support and time to lease-up with housing vouchers could provide longer-term benefits for families.

Acknowledgments

This project was supported by Award Number R01HD067540 from the Eunice Kennedy Shriver National Institute of Child Health and Human Development, award 90CA1815-01-00 from the Administration for Children and Families Children's Bureau, and awards 1927422 and 1910392 from the National Science Foundation. The content is solely the responsibility of the authors and does not necessarily represent the official views of the Eunice Kennedy Shriver National Institute of Child Health and Human Development or the National Institutes of Health. We acknowledge the families and service providers who partnered in the research.

Authors

Patrick Fowler is faculty in the Brown School and Division of Computational and Data Sciences at Washington University in St. Louis. Andrew Foell is an assistant professor in the Jane Adams School of Social Work at the University of Illinois at Chicago. Anne Rufa is in the Department of Psychiatry and Behavioral Sciences at the Rush University Medical Center. Michael Schoeny is in the Department of Community, Systems and Mental Health Nursing in the College of Nursing at Rush University.

References

Barth, Richard P., Judy Wildfire, and Rebecca L. Green. 2006. "Placement into Foster Care and the Interplay of Urbanicity, Child Behavior Problems, and Poverty," *American Journal of Orthopsychiatry* 76 (3): 358–366. <https://doi.org/10.1037/0002-9432.76.3.358>.

Belli, Robert F., William L. Shay, and Frank P. Stafford. 2001. "Event History Calendars and Question List Surveys: A Direct Comparison of Interviewing Methods," *Public Opinion Quarterly* 65 (1): 45–74. <https://doi.org/https://doi.org/10.1086/320037>.

Bergman, Peter, Raj Chetty, Stefanie DeLuca, Nathaniel Hendren, Lawrence F. Katz, and Christopher Palmer. 2019. *Creating Moves to Opportunity: Experimental Evidence on Barriers to Neighborhood Choice*. NBER Working paper No. 26164. Cambridge, MA: National Bureau of Economic Research. <https://www.nber.org/papers/w26164>.

Bliese, Paul D., Amy B. Adler, and Patrick J. Flynn. 2017. "Transition Processes: A Review and Synthesis Integrating Methods and Theory," *Annual Review of Organizational Psychology and Organizational Behavior* 4 (1): 263–286.

Coulton, Claudia J., David S. Crampton, Molly Irwin, James C. Spilsbury, and Jill E. Korbin. 2007. "How Neighborhoods Influence Child Maltreatment: A Review of the Literature and Alternative Pathways," *Child Abuse and Neglect* 31 (11–12): 1117–1142. <https://doi.org/10.1016/j.chiabu.2007.03.023>.

Cunningham, Mary, Martha Galvez, Claudia L. Aranda, Rob Santos, Doug Wissoker, Alyse Oneto, Rob Pitingolo, and James Crawford. 2018. *A Pilot Study of Landlord Acceptance of Housing Choice Vouchers*. Report prepared for the U.S. Department of Housing and Urban Development, Office of Policy Development and Research. Washington, DC: U.S. Government Printing Office. <https://www.huduser.gov/portal/portal/sites/default/files/pdf/Landlord-Acceptance-of-Housing-Choice-Vouchers.pdf>.

Cunningham, Mary, and Michael Pergamit. 2015. "Housing Matters for Families: Promising Practices from Child Welfare Agencies," *Child Welfare* 94 (1): 123–140.

D'Andrade, Amy, James D. Simon, Danna Fabella, Lolita Castillo, Cesar Mejia, and David Shuster. 2017. "The California Linkages Program: Doorway to Housing Support for Child Welfare-Involved Parents," *American Journal of Community Psychology* 60 (1–2): 125–133. <https://doi.org/10.1002/ajcp.12099>.

Dalal, Reeshad S., Balca Alaybek, and Filip Lievens. 2020. "Within-Person Job Performance Variability over Short Timeframes: Theory, Empirical Research, and Practice," *Annual Review of Organizational Psychology and Organizational Behavior* 7: 421–449.

DeLuca, Stefanie, Philip M. E. Garboden, and Peter Rosenblatt. 2013. "Segregating Shelter: How Housing Policies Shape the Residential Locations of Low-Income Minority Families," *Annals of the American Academy of Political and Social Science* 647 (1): 268–299. <https://doi.org/10.1177/0002716213479310>.

DeLuca, Stefanie, Holly Wood, and Peter Rosenblatt. 2019. "Why Poor Families Move (and Where They Go): Reactive Mobility and Residential Decisions," *City and Community* 18 (2): 556–593. <https://doi.org/10.1111/cico.12386>.

- Devine, Deborah, Robert Gray, Lester Rubin, and Lydia Taghavi. 2003. *Housing Choice Voucher Location Patterns: Implications for Participant and Neighborhood Welfare*. Report prepared for the U.S. Department of Housing and Urban Development, Office of Policy Development and Research. Washington, DC: U.S. Government Printing Office. https://www.huduser.gov/publications/pdf/location_paper.pdf.
- Egan J. C. 2007. *Navigating the Housing Maze: The Housing Advocate's Manual*. University Park, MD: National Center for Housing and Child Welfare.
- Ellen, Ingrid G. 2018. "What Do We Know About Housing Choice Vouchers?" *Regional Science and Urban Economics* 1–5. <https://doi.org/10.1016/j.regsciurbeco.2018.07.003>.
- Eriksen, Michael D., and Amanda Ross. 2013. "The Impact of Housing Vouchers on Mobility and Neighborhood Attributes," *Real Estate Economics* 41 (2): 255–277. <https://doi.org/10.1111/j.1540-6229.2012.00342.x>.
- Feins, Judith D., and Rhiannon Patterson. 2005. "Geographic Mobility in the Housing Choice Voucher Program: A Study of Families Entering the Program, 1995–2002," *Cityscape* 8 (2): 21–47.
- Fowler, Patrick J., Derek S. Brown, Michael Schoeny, and Saras Chung. 2018. "Homelessness in the Child Welfare System: A Randomized Controlled Trial To Assess the Impact of Housing Subsidies on Foster Care Placements and Costs," *Child Abuse and Neglect* 83: 52–61. <https://doi.org/10.1016/j.chiabu.2018.07.014>.
- Fowler, Patrick J., and Dina Chavira. 2014. "Family Unification Program: Housing Services for Homeless Child Welfare-Involved Families," *Housing Policy Debate* 24 (4): 802–814. <https://doi.org/10.1080/10511482.2014.881902>.
- Fowler, Patrick J., Anne F. Farrell, Katherine E. Marcal, Saras Chung, and Peter S. Hovmand. 2017. "Housing and Child Welfare: Emerging Evidence and Implications for Scaling up Services," *American Journal of Community Psychology* 60 (1–2): 134–144. <https://doi.org/10.1002/ajcp.12155>.
- Fowler, Patrick J., David B. Henry, Michael Schoeny, John Landsverk, Dina Chavira, and Jeremy J. Taylor. 2013. "Inadequate Housing Among Families Under Investigation for Child Abuse and Neglect: Prevalence from a National Probability Sample," *American Journal of Community Psychology* 52 (1–2): 106–114. <https://doi.org/10.1007/s10464-013-9580-8>.
- Fowler, Patrick J., and Michael Schoeny. 2017. "Permanent Housing for Child Welfare-Involved Families: Impact on Child Maltreatment," *American Journal of Community Psychology* 60 (1–2): 91–102. <https://doi.org/10.1002/ajcp.12146>.
- Fowler, Patrick J., Paul A. Toro, and Bart W. Miles. 2009. "Pathways to and from Homelessness and Associated Psychosocial Outcomes Among Adolescents Leaving the Foster Care System," *American Journal of Public Health* 99 (8): 1453–1458. <https://doi.org/10.2105/AJPH.2008.142547>.
- Freedman, D., A. Thornton, D. Camburn, D. Alwin, and L. Young-DeMarco. 1988. "The Life History Calendar: A Technique for Collecting Retrospective Data," *Sociological Methodology* 18: 37–68. <https://doi.org/10.2307/271044>.

Freisthler, Bridget, Darcey H. Merritt, and Elizabeth A. LaScala. 2006. "Understanding the Ecology of Child Maltreatment: A Review of the Literature and Directions for Future Research," *Child Maltreatment* 11 (3): 263–280. <https://doi.org/10.1177/1077559506289524>.

Galvez, Martha, and Sarah Oppenheimer. 2020. *Taking Neighborhood Mobility to Scale Through the Housing Choice Voucher Program*. Report prepared for the U.S. Department of Housing and Urban Development, Office of Policy Development and Research. Washington, DC: U.S. Government Printing Office. <https://www.urban.org/sites/default/files/publication/103026/taking-neighborhood-mobility-to-scale.pdf>.

Gubits, Daniel, Marybeth Shinn, Michael Wood, Scott R. Brown, Samuel R. Dastrup, and Stephen H. Bell. 2018. "What Interventions Work Best for Families Who Experience Homelessness? Impact Estimates from the Family Options Study," *Journal of Policy Analysis and Management* 37 (4): 835–866.

Hox, Joop, and Daniel McNeish. 2018. "Small Samples in Multilevel Modeling." In *Small Samples in Multilevel Modeling: A Guide for Applied Researchers and Practitioners*, edited by R. Van De Schoot and M. Miočević. New York, NY: Routledge: 215–225.

Hoyle, Rick H., and Nisha C. Gottfredson. 2015. "Sample Size Considerations in Prevention Research Applications of Multilevel Modeling and Structural Equation Modeling," *Prevention Science* 16: 987–996. <https://doi.org/10.1007/s1121-014-0489-8>.

Kahan, Brennan C., Vipul Jairath, Caroline J. Doré, and Tim P. Morris. 2014. "The Risks and Rewards of Covariate Adjustment in Randomized Trials: An Assessment of 12 Outcomes from 8 Studies," *Trials* 15: 139. <https://doi.org/10.1186/1745-6215-15-139>.

Lens, M., I. Ellen, and K. O'Regan. 2011. "Do Vouchers Help Low-Income Households Live in Safer Neighborhoods? Evidence on the Housing Choice Voucher Program," *Cityscape* 13 (3): 135–159.

Ludwig, Jens, Greg J. Duncan, Lisa Gennetian, Lawrence F. Katz, Ronald Kessler, Jeffery R. Kling, and Lisa Sanbonmatsu. 2013. "Long-Term Neighborhood Effects on Low-Income Families: Evidence from Moving to Opportunity," *American Economic Review* 103 (3): 226–231.

Maas, Cora J., and Joop J. Hox. 2005. "Sufficient Sample Sizes for Multilevel Modeling," *Methodology: European Journal of Research Methods for the Behavioral and Social Sciences* 1 (3): 86.

Maguire-Jack, Kathryn, and Sarah A. Font. 2017. "Intersections of Individual and Neighborhood Disadvantage: Implications for Child Maltreatment," *Children and Youth Services Review* 72: 44–51. <https://doi.org/10.1016/j.childyouth.2016.10.015>.

Mazzara, Alicia, and Brian Knudsen. 2019. "Where Families with Children Use Housing Vouchers: A Comparative Look at the 50 Largest Metropolitan Areas." Washington, DC: Center on Budget and Policy Priorities.

McCaskill, Pamela A., Paul A. Toro, and Susan M. Wolfe. 1998. "Homeless and Matched Housed Adolescents: A Comparative Study of Psychopathology," *Journal of Clinical Child Psychology* 27 (3): 306–319. https://doi.org/10.1207/s15374424jccp2703_7.

Newman, Sandra J., and Ann B. Schnare. 1997. "...And a Suitable Living Environment: The Failure of Housing Programs to Deliver on Neighborhood Quality," *Housing Policy Debate* 8 (4): 703–741. <https://www.tandfonline.com/doi/abs/10.1080/10511482.1997.9521275>.

Nguyen, Quynh C., Dolores Acevedo-Garcia, Nicole M. Schmidt, and Theresa L. Osypuk. 2017. "The Effects of a Housing Mobility Experiment on Participants' Residential Environments," *Housing Policy Debate* 27 (3): 419–448. <https://doi.org/10.1080/10511482.2016.1245210>.

Park, John, and Kyle Shelton. 2019. *Housing Choice Voucher Mobility in Houston*. Houston, TX: Rice University Kinder Institute for Urban Research.

Patterson, Kelly L., and Eun-Hye Enki Yoo. 2012. "Trapped in Poor Places? An Assessment of the Residential Spatial Patterns of Housing Choice Voucher Holders in 2004 and 2008," *Journal of Social Service Research* 38 (5): 637–655. <https://doi.org/10.1080/01488376.2012.706698>.

Pergamit, Michael, Mary Cunningham, and Delin Hanson. 2017. "The Impact of Family Unification Housing Vouchers on Child Welfare Outcomes," *American Journal of Community Psychology* 60 (1–2): 103–113. <https://doi.org/10.1002/ajcp.12136>.

Pergamit, Michael, Mary Cunningham, Devlin Hanson, and Alexandra Stanczyk. 2019. *Does Supportive Housing Keep Families Together? Supportive Housing for Child Welfare Families Research Partnership*. Washington, DC: Urban Institute. https://www.urban.org/sites/default/files/publication/100289/does_supportive_housing_keep_families_together.pdf.

Rog, Debra J., Kathryn A. Henderson, Laurel M. Lunn, Andrew L. Greer, and Mei L. Ellis. 2017. "The Interplay Between Housing Stability and Child Separation: Implications for Practice and Policy," *American Journal of Community Psychology* 60 (1–2): 114–124.

Rosen, Eva. 2014. "Rigging the Rules of the Game: How Landlords Geographically Sort Low-Income Renters," *City and Community* 13 (4): 310–340. <https://doi.org/10.1111/cico.12087>.

Rosenblatt, Peter, and Stefanie DeLuca, S. 2012. "We Don't Live Outside, We Live in Here: Neighborhood and Residential Mobility Decisions Among Low-Income Families," *City and Community* 11 (3): 254–284. <https://doi.org/10.1111/j.1540-6040.2012.01413.x>.

Rufa, Anne K., and Patrick J. Fowler. 2018. "Housing Decisions Among Homeless Families Involved in the Child Welfare System," *Housing Policy Debate* 28 (2): 285–298. <https://doi.org/10.1080/10511482.2017.1365256>.

Sampson, Robert J. 2012. *Great American City: Chicago and the Enduring Neighborhood Effect*. University of Chicago Press.

Sanbonmatsu, Lisa, Nicholas A. Potter, Emma Adam, Greg J. Duncan, Lawrence R. Katz, Ronald C. Kessler, Jens Ludwig, Jordon Marvakov, Fanghua Yang, William J. Congdon, Lisa Gennetian, Jeffery R. Kling, Stacy T. Lindau, and Thomas W. McDade. 2012. "The Long-Term Effects of Moving to Opportunity on Adult Health and Economic Self-Sufficiency," *Cityscape* 14 (2): 109–136. <https://www.jstor.org/stable/41581100>.

Schwartz, Heather L., Kata M. Mihaly, and Breann Gala. 2017. "Encouraging Residential Moves to Opportunity Neighborhoods: An Experiment Testing Incentives Offered to Housing Voucher Recipients," *Housing Policy Debate* 27 (2): 230–260. <https://doi.org/10.1080/10511482.2016.1212247>.

Singer, Judith D., and John B. Willett. 2003. *Applied Longitudinal Data Analysis: Modeling Change and Event Occurrence*. Oxford University Press. <https://doi.org/https://doi.org/10.1093/acprof:oso/9780195152968.001.0001>.

U.S. Census Bureau. 2014. "American Community Survey Design and Methodology (January 2014)." https://www2.census.gov/programs-surveys/acs/methodology/design_and_methodology/2014/acs_design_methodology_ch05_2014.pdf.

U.S. Department of Justice. 2013. "Summary Reporting System (SRS) User Manual." <https://le.fbi.gov/file-repository/summary-reporting-system-user-manual.pdf/view>.

Winters, Andrew M., Crystal Collins-Camargo, Becky F. Antle, and A. Nathan Verbist. 2020. Implementation of System-Wide Change in Child Welfare and Behavioral Health: The Role of Capacity, Collaboration, and Readiness for Change," *Children and Youth Services Review* 108: 104580. <https://doi.org/10.1016/j.childyouth.2019.104580>.

Yoshihama, Mieko, and Deborah Bybee. 2011. "The Life History Calendar Method and Multilevel Modeling: Application to Research on Intimate Partner Violence," *Violence Against Women* 17 (3): 295–308. <https://doi.org/10.1177/1077801211398229>.

Zhang Min, Anastasios A. Tsiatis, and Marie Davidian. 2008. "Improving Efficiency of Inferences in Randomized Clinical Trials Using Auxiliary Covariates," *Biometrics* 64 (3): 707–715.

Departments

In this issue—

- *Data Shop*
- *Foreign Exchange*
- *Graphic Detail*
- *Impact*
- *Industrial Revolution*

Data Shop

Data Shop, a department of Cityscape, presents short articles or notes on the uses of data in housing and urban research. Through this department, the Office of Policy Development and Research introduces readers to new and overlooked data sources and to improved techniques in using well-known data. The emphasis is on sources and methods that analysts can use in their own work. Researchers often run into knotty data problems involving data interpretation or manipulation that must be solved before a project can proceed, but they seldom get to focus in detail on the solutions to such problems. If you have an idea for an applied, data-centric note of no more than 3,000 words, please send a one-paragraph abstract to chalita.d.brandly@hud.gov for consideration.

Move-In Fees as a Residential Sorting Mechanism Within Online Rental Markets

Remy Stewart
Cornell University

Chris Hess
Kennesaw State University

Ian Kennedy
Rice University

Kyle Crowder
University of Washington

Abstract

An increasing number of American renters within major metropolitan housing markets rely on online platforms such as Craigslist to find rental units. Landlords that advertise rentals on these websites have been found to tailor the language used in their listings in reference to surrounding neighborhood demographics to influence prospective tenants' rental searches. This work investigates the underexplored subject of move-in fees, referring to upfront costs to secure a lease, such as security deposits, application charges, and advanced rent payments that can affect whether a prospective renter can afford an advertised unit. This study advances a framework for how housing researchers can assess variations in

Abstract (continued)

landlord discourse within online housing marketplaces using text analysis methods and web scraping. It then illustrates how the resulting measures about move-in fees have distinct variations in prevalence along sociodemographic, spatial, and policy measures through a series of descriptive analyses, with subsequent conclusions toward policy implications designed to assist low-income renters with overcoming financial barriers in securing rental housing.

Introduction

As more residents in large American metropolitan housing markets rent instead of owning homes, more households are conducting rental searches through online marketplaces such as Craigslist, Zillow, and Apartments.com (U.S. Census Bureau, 2019). These platforms connect renters to available units through landlords' advertisements that specify relevant features, such as cost, unit location, and leasing requirements.

The growing importance of these novel marketplaces toward rental searches and macro-level residential sorting trends has promoted scholarship that explores large datasets of online rental advertisements through text analysis methods. Research has identified that landlords vary in the language they use and provide disparate information about rental units, depending on the racial, ethnic, and socioeconomic composition of the neighborhood in which a unit is located (Adu and Delmelle, 2022; Besbris, Schachter, and Kuk, 2021; Kennedy et al., 2021). This variation implies intentionality behind what landlords decide to specify in their listing advertisements. To the extent that it corresponds with neighborhood conditions, this inconsistency in information may exacerbate residential stratification by shaping perceptions of—and limiting opportunities to obtain rentals within—specific neighborhoods (Krysan and Crowder, 2017).

Whereas both the home purchasing and rental markets are influenced by the behavior of brokers that attempt to sort prospective residents, rentals are generally vetted by a smaller number of actors compared with the range of individuals involved with home purchases, such as real estate agents and loan providers (Korver-Glenn, 2018). Screening is commonly spearheaded by landlords, who are incentivized to shape the applicant pool for their listing from the initial public advertisement of their unit.

Qualitative research into landlords' motivations for shaping their tenant application pools emphasizes how landlords attempt to secure tenants they perceive as likely to demonstrate desired behaviors, such as consistently paying rent on time (Desmond, 2016; Rosen, 2014). This process is additionally contextualized by ongoing discrimination toward particular rental groups based on stereotypes of lower-income renters or renters of color as unreliable and disruptive tenants (Rosen, Garboden, and Cossyleon, 2021). Those biases are also implicated within discrimination toward renters participating in the Housing Choice Voucher (HCV) program. Source of income (SOI) laws aim to prevent landlord discrimination against voucher holders, which prior scholarship has found

to be present in online Craigslist rental advertisements (Besbris et al., 2022; Hangen and O'Brien, 2022; Tighe, Hatch, and Mead, 2017).

Beyond its substantive importance, analyzing how landlords on platforms such as Craigslist, a leading online rental marketplace, attempt to shape the rental search process of prospective tenants is also a research subject well served by novel data collection techniques and methodologies. Gathering large datasets of nationally distributed rental ads provides a comprehensive sample of advertisement text that can then be processed through text analysis methods that identify patterns of language variation with implications for residential sorting. However, this combined data collection and methodological strategy presents challenges regarding acquiring data effectively and then processing large amounts of text. Language-based data depend more on subjective contexts than classic structured data types, such as continuous variables (Grimmer, Roberts, and Stewart, 2022). This work therefore advances a computational text-processing methodological approach by analyzing 1.3 million nationally distributed Craigslist rental advertisements grounded within emergent best practices regarding robustly identifying patterns and insights within text data.

The present study considers the underexplored topic of specified move-in fees by Craigslist landlords. The total price to secure a rental lease can include both the monthly rent obligation and additional upfront costs such as security deposits, the first or last month's rent (or both) paid in advance, and various fees levied for the rental application, credit score verification, and other administrative processes. These move-in fees often require large sums of money to be paid at once, which imposes significant financial burdens on many renting households and limits renters' prospective choice of potential units (Duke-Lucio, Peck, and Segal, 2010; Messing et al., 2021; Orians, 2016).

Specifying move-in fees within a rental listing is theoretically grounded in two distinct goals for landlords when coordinating rental transactions. Move-in fees can exclude prospective applicants by increasing the upfront cost of securing a lease, thereby discouraging applications from lower-income renters. Alternatively, move-in fees may be mentioned in a market deal, such as advertising a discounted security deposit to obtain a tenant for a unit that may otherwise remain vacant due to neglected unit maintenance or an unfavorable location. Both scenarios indicate how a landlord's decision to specify a move-in fee requirement within an advertisement can influence rental market dynamics, with subsequent impact on the housing searches of lower-income renters.

Interest in policy initiatives has been growing within metropolitan rental markets in states such as New York, Utah, and Washington to either limit additional move-in fees—most commonly security deposit costs—or require landlords to specify all associated leasing costs explicitly, given the financial burdens these fees impose on renters (Judkins, 2020; Stewart-Cousins, 2019). Although SOI legislation offers protections towards one rental market vetting mechanism against low-income renters, landlords can employ move-in fees to position units as financially untenable for HCV recipients because regional HCV programs often do not assist with move-in fees (Metzger et al., 2019). This study therefore investigates how concurrent policy environments that adopt either or both SOI anti-discrimination legislation and security deposit cost limits potentially influence landlords' specification of move-in fees in listing advertisements.

An additional relevant question is regarding how landlords may vary in their tendency to specify move-in fees in their advertisements based on their rental units' immediate and surrounding neighborhoods. Consistent with research about place stratification in the housing search process, landlords may be more likely to deliberately include move-in fee requirements in neighborhoods with either higher neighborhood poverty levels or higher proportions of residents of color. Poverty levels in adjacent neighborhoods and racial composition proximate to the immediate census tract of a unit may also influence landlords' tendencies to include move-in fee requirements. This hypothesis draws from the established influence of adjacent tract characteristics on housing market dynamics and residential sorting, which is a comparatively underexplored subject in the context of online rental market platforms (Logan and Zhang, 2010; Ramiller, 2022).

The results of this study highlight how landlords mention move-in fee requirements in Craigslist rental advertisements at a significantly lower rate than their estimated prevalence in rental markets, indicating potential intentionality regarding when move-in fees are specified. One important dimension of this dynamic is that landlords are more likely to specify security deposit requirements in metropolitan regions that have adopted SOI anti-discrimination legislation. Regression models employing metropolitan-level fixed effects demonstrate that the most prominent predictor of a landlord specifying a security deposit requirement is proximity to other census tracts with higher poverty levels, whereas, for application fees and first or last month's rent, both immediate and proximate higher poverty are predictive of a higher mention likelihood. Overall, these results illustrate how move-in fee requirements may serve as a sorting mechanism among landlords operating in lower-cost rental markets affected by regional regulatory contexts regarding housing assistance. The article concludes by considering the implications of these results for policy initiatives aiming to assist low-income renters with securing rental housing.

Data and Methods

This study uses a unique database of Craigslist housing advertisements collected from July through August of 2019 using the Helena web automation programming language.¹ These data cover the largest 100 metropolitan areas in the United States by population size and include each of the submarkets that may exist for a given core-based statistical area as defined by the Office of the Management and Budget (e.g., the Los Angeles-Long Beach-Santa Ana CBSA covers Craigslist's "Los Angeles" and "Orange County" locations). Duplicate listings in the raw data are removed based on uniquely observed listing texts, leaving a total sample of 1.3 million listings covering 41,620 tracts. Units may be represented multiple times in the sample when landlords change their advertisement language slightly, such as by posting a different security deposit price. These listings are included within the dataset to preserve the representativeness of landlords' use of Craigslist rental advertisements, assuming that they constitute a minority of the sample. These data and methods have been used in prior research about rental housing platforms (Costa et al., 2021; Hess et al., 2019), and additional information about the data collection and processing is available in a recent article assessing Craigslist's representation of different neighborhoods (Hess et al., 2021).

¹ Helena is a programming-by-demonstration language for web automation focused on web data, even in cases in which the data of interest are distributed across a number of pages or are constantly being generated over time. Readers interested in reproducing the system used for the present study should consult a recent article describing how to develop and scale such a system using Helena in combination with other open-source software (Hess and Chasins, 2022).

Following data collection, text analysis methods were used to robustly identify when landlords specify move-in fees in rental advertisements. This work builds from an established approach that combines both computationally provided insights regarding word and phrase frequencies with close readings of the advertisement listings to better understand the subjective context behind discovered trends in text data (Nelson, 2020). Natural language processing attempts to quantify the unique language characteristics of a population of interest and, therefore, must contend with the inevitable nuances of text related to divergent contexts and language irregularities. Close readings were therefore conducted to understand how landlords construct rental advertisements that specify move-in fee requirements, which additionally identified surprising themes and insights within the text used to further refine the computational analysis methodology.

Exhibit 1 delineates the final text analysis workflow. The stringr text data manipulation package within the R statistical computing programming language was used to generate indicator variables for the mention of a move-in fee requirement in a landlord’s listing description. The listing’s text was preprocessed by removing nonalphanumeric characters and then used to generate baseline counts of “deposits,” “first month,” and “last month” mentions. A subsequent review of the descriptions that were indicated as either mentioning or not specifying one of these move-in fee requirements highlighted two additional factors in the listing text that needed to be accounted for. First was the prevalence of “pet deposits” as a separate requirement regarding allowing pets in a unit distinct from this study’s research interests, which prompted the removal of those mentions from subsequent listings’ texts. Second was different written formats to specify a “1st month” or “last month” rent requirement. The most common alternative text specifications of these move-in fees were reviewed in the dataset, and their syntax was added to the scope of the text-matching parameters. This final iteration on the keywords was therefore used to complete the identification of mentioned deposits, first month rent, and last month rent requirements as tailored to the unique characteristics of the Craigslist advertisement text.

Exhibit 1

Workflow for Refining Text Analysis of Move-in Fee Mentions in Craigslist Rental Advertisements

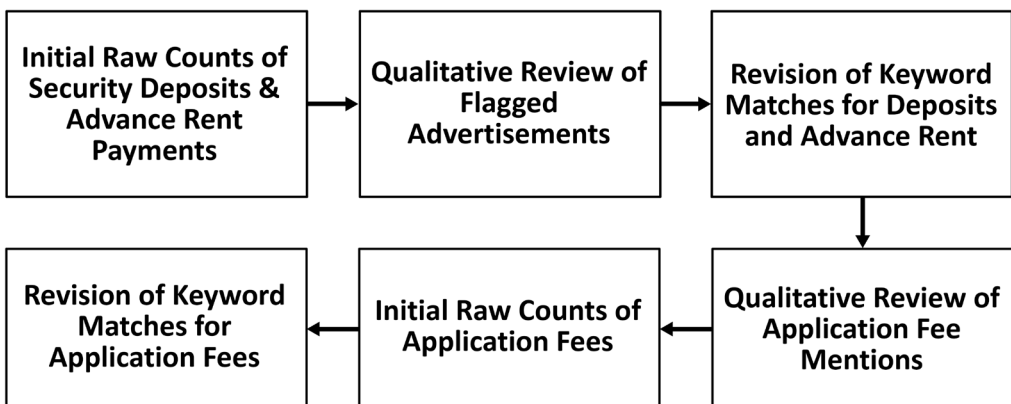

Source: Authors’ identified methodological approach

The analysis proceeded by flagging “application,” “screening,” “processing,” “verification,” and “credit check” fee mentions, following a similar qualitative content review of these fee specifications throughout the dataset. Mentions of “broker fees” were intentionally left unmatched because this charge is disproportionately driven by the New York-Newark-Jersey City metropolitan area rental market and is, therefore, not representative of national trends. Direct specifications of “fees” and “charges” were captured rather than any mention of an application within the advertisement that did not specify an associated fee. Although many requested applications likely require a processing fee payment, these ambiguous mentions were not included due to missing information and because the intentional specification of a fee is the most relevant behavior for this study’s research interests.

The analytic strategy for assessing the prevalence of move-in fee mentions in online rental ads consists of three parts. First, descriptive statistics about the rate of mention and example texts are used to illustrate differences in how landlords mention the three focal types of fees. Then, a figure illustrates rates of mention based on whether a listing falls within a jurisdiction with either (a) SOI protections or (b) deposit limit laws to consider how landlords change their tendencies across markets with different regulatory environments. Finally, an additional figure illustrates the average marginal effects of different neighborhood and listing characteristics on the likelihood of a rental ad mentioning a given type of move-in fee.

Linear probability models (LPM) were estimated to generate these average marginal effects, with listing-level measures of rent asked (in \$100s) and square footage (in 100s) combined with a variety of census tract-level measures derived from the 2015–2019 American Community Survey 5-year estimates.² The first of these tract measures concern housing unit mix and turnover, with measures specifically capturing median gross rent (in \$100s), the share of housing units that are in single-family detached buildings (hereafter: Share Single Family Homes), the share of housing units (HU) that are in structures with 20+ units (Share HU in 20+ Bldgs), the share of HU that is renter occupied (Share Renter Occupied), and the share of persons who lived in the same home during the past year (Share Same Home Last Year). Next, another set of measures captures the sociodemographic composition of the tract where a listing is located, with a set of categories denoting tract racial/ethnic composition (Multiethnic, Predominantly Asian/PI [Pacific Islander], Predominantly Black, Predominantly Latino, and Predominantly White) and a dummy variable indicating whether the tract has poverty prevalence of 20 percent or more (High Poverty). Finally, the role of surrounding neighborhoods in shaping landlord discourse online is considered with a set of spatially lagged measures for sociodemographic composition in tracts adjacent to the one where a given listing is located. The measure for adjacency to high poverty takes a value of 1 if any neighboring tracts are high poverty (Adjacent to High Poverty), whereas the other measures of adjacent ethnoraical composition can be interpreted as the proportion of a tract’s edges that are neighborhoods of a particular racial or ethnic composition (Adjacent to Multiethnic, Adjacent to Predominantly Asian/PI, etc.).

² No substantive differences in coefficient significance were found when estimating logistic regression models with similar covariate specifications. As such, the LPM results for the coefficients are presented for greater ease of interpretation on the metric of probability.

All models include metropolitan fixed effects to adjust for time-invariant differences in mention rates between different metropolitan areas. Standard errors clustered by metropolitan area were used to account for heteroskedasticity and the nonindependence of errors in a given metropolitan region. Finally, although focal results from these models are presented in terms of the average marginal effects that reach statistical significance at the $p < .05$ significance level, the full model tables for the LPMs and logistic regression models are included in the appendix.

Results

The frequency of move-in fee mentions identified via the text analysis indicates that all types of move-in fee requirements are specified by landlords posting on Craigslist markedly less often than their expected prevalence within metropolitan housing markets, as highlighted in exhibit 2. The found specification rate of security deposit requirements in about 21 percent of the collected advertisements starkly contrast with Zillow Group’s Consumer Housing Trends annual report for 2021 estimation that 88 percent of renters pay a security deposit when signing a new lease (Garcia and Berchick, 2021). Whereas various application fees and first or last month’s rent do not have empirical estimates of their prevalence across U.S. rental markets, the low percentages of identified mentions suggest a lesser specification rate in advertisements than their actual pervasiveness within rental markets. This low overall occurrence of move-in fee specification raises the question regarding when landlords intentionally choose to specify said requirements, given the low tendency to delineate move-in fees overall.

Exhibit 2

Move-in Fee Prevalence and Text Representation Examples

Move-in Fee	Proportion	Text Examples
Security Deposits	21%	<ul style="list-style-type: none"> • “Security deposit requested upon signing.” • “\$100 off deposit this week only!”
Application Fee	6%	<ul style="list-style-type: none"> • “Pay application fee online (non-refundable).” • “Verification fee charged with credit check.”
First and/or Last Month’s Rent	3%	<ul style="list-style-type: none"> • “1st & last month rent required to secure unit.” • “First mo rent + deposit will be paid via check.”

Source: Authors’ calculations based on data scraped from Craigslist

Accordingly, whether location within a jurisdiction with SOI protections, presence in a state that regulates requestable security deposit amounts, or the combination of both policies is associated with differences in Craigslist advertisement move-in fee mention rates was examined. Exhibit 3 displays the distribution of mention rates by move-in fee category delineated by the applicability of either policy for each advertisement. The findings highlight that the presence of SOI protections is coupled with a greater security deposit specification rate within Craigslist rental advertisements, particularly among metropolitan regions that do not concurrently enforce deposit amount limits. These results indicate a similar association regarding application fee mentions but do not suggest a difference in mention rates for regions without SOI anti-discrimination policies.

Exhibit 3

Move-in Fee Mention Rates by Presence of Source-of-Income (SOI) Protections and State Laws Limiting Security Deposits

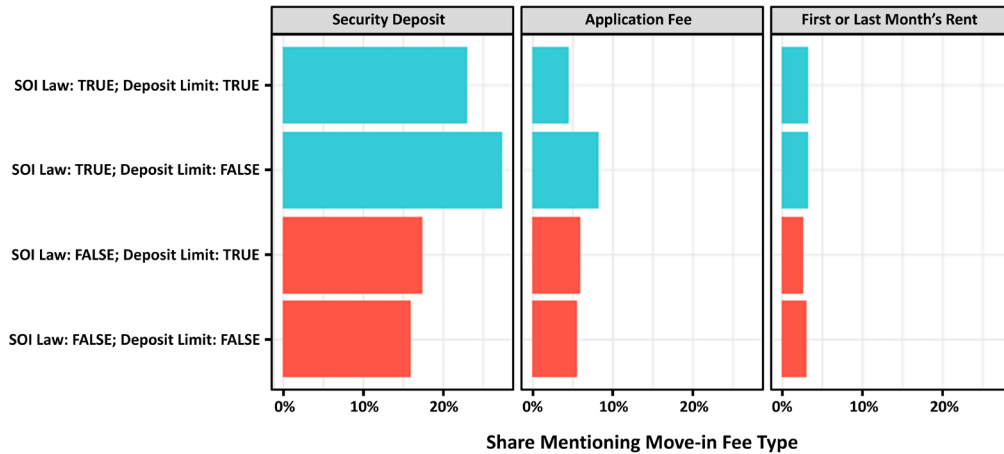

Source: Authors' calculations based on data scraped from Craigslist

The findings imply a notable trend regarding the presence of policies designed to inhibit SOI discrimination by landlords as linked to a greater prevalence of security deposit specifications within rental advertisements. Given the discovered context of landlords specifying move-in fees in Craigslist advertisements at a lower rate than their expected prevalence within rental markets, these results demonstrate a potential response from landlords to SOI regulations of intentionally specifying security deposit requirements as a substitute mechanism for discouraging renters with HCV vouchers from applying for a rental. Because housing assistance programs often do not assist with move-in fees such as security deposits, the increased move-in fee mention rates in advertisements in regions with SOI protections may serve as an alternative strategy to influence the housing search behavior of low-income renters in metropolitan areas that attempt to restrict SOI discrimination.

Finally, building from these initial insights regarding move-in fee mention prevalence and the potential influence of regional contexts on move-in fee mentions, this study considered how neighborhood demographic characteristics within both immediate and proximate census tracts are associated with variation in fee specification rates. Exhibit 4 illustrates the average marginal effects of neighborhood and listing characteristics following fitting LPM models for each type of move-in fee.

Exhibit 4

Average Marginal Effects of Neighborhood and Listing Characteristics on Probability of Mentioning Different Types of Move-in Fees

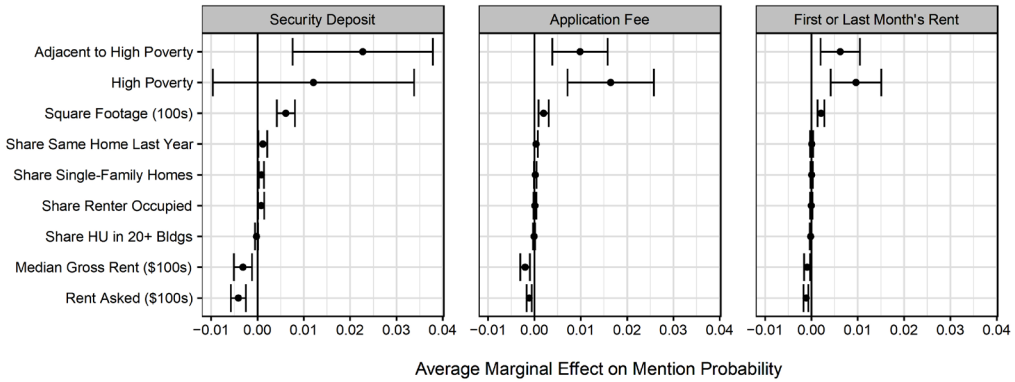

HU = housing unit.

Source: Authors' calculations based on data scraped from Craigslist and ACS 5-Year Public Use Microdata Sample

The core finding from these models is the distinctive influence of either immediate poverty levels or adjacent poverty on the increased likelihood of landlords specifying a move-in fee requirement in the Craigslist advertisements. Proximity to a high-poverty census tract is the leading predictor of a security deposit requirement being mentioned in a listing, whereas both immediate and proximate poverty are associated with significant increases in the probability of an application fee or advance rent payment being requested. Exhibit 4 demonstrates that although listing characteristics such as greater square footage and higher rents are also predictive of move-in fee mentions, the effect size for these terms is notably smaller than for immediate and adjacent poverty levels.

An important finding is that no observed relationship exists between either immediate or adjacent neighborhood racial and ethnic composition on landlords' move-in fee specification rates. These findings support the original prediction of the influence of either immediate or proximate poverty on move-in fee mentions, but they contradict the accompanying expectation of the dual importance of racial and ethnic neighborhood composition. Although these results demonstrate a more complicated dynamic related to move-in fee mention rates than originally predicted, these results are likely linked with each because of the close relationship between household income and racial and ethnic demographics within U.S. metropolitan regions. This inference is also implicated with the identified tendency to specify move-in fee requirements in regions with SOI protections because HCV recipients are often more racially and ethnically diverse than the total renter populations in a given region (U.S. Department of Housing and Urban Development, 2022). The significant influence of both immediate and proximate poverty levels on landlords' specifications of move-in fees, therefore, implies ramifications for rental market dynamics being relevant to socioeconomic, racial, and ethnic differences simultaneously.

Discussion

In addition to demonstrating the general utility of data scraped from online rental advertisements, this investigation of the prevalence rates and regional dynamics of move-in fees specified within Craigslist rental advertisements highlights distinctive trends regarding this underexplored component of rental market sorting. The delineated text analysis methodology identified that move-in fees are mentioned by landlords at a lower frequency than their estimated occurrence rate in rental transactions. These findings were further contextualized with additional analyses demonstrating the influence of regional SOI policy protections and immediate and proximate neighborhood poverty levels on higher move-in fee mention rates. The findings therefore provide evidence of landlords employing move-in fees as a sorting mechanism early during rental transactions to shape market dynamics as primarily applicable to lower-income tenants, including those receiving housing choice vouchers.

Move-in fees can significantly influence the financial feasibility of a rental for lower-income households; these results, therefore, support policy initiatives that assist with meeting these costs to mitigate stratification associated with this particular residential sorting mechanism. This issue is a timely policy topic relevant to recent guidance from HUD's Office of Public and Indian Housing supporting public housing authorities toward allocating administrative fees to assist HCV recipients in paying move-in fee expenses (HUD PIH, 2022). Said findings testify to the importance of this emergent policy direction in support of overarching goals of fostering more socioeconomically diverse neighborhoods and deconcentrating residential poverty levels.

This research note advances a brief exploration of move-in fees in Craigslist rental advertisements with a dataset gathered over a short 2-month timeframe. The introduced research topic and the methodological approach are ideal candidates for future research exploring additional dynamics, such as longitudinal changes in mention rates and how this study's findings translate to other online housing marketplaces, such as Apartments.com or Zillow. This work is therefore intended to serve as a topical and methodological introduction regarding move-in fees as a residential sorting mechanism in online rental marketplaces. The authors thereby support future scholarship employing text analysis methods on large datasets to explore novel research questions relevant to housing policy and residential stratification.

Acknowledgments

Partial support for this research came from a Eunice Kennedy Shriver National Institute of Child Health and Human Development research infrastructure grant, P2C HD042828, to the Center for Studies in Demography & Ecology at the University of Washington, as well as from the National Science Foundation Graduate Research Fellowship Program under Grant No. 1650441.

Authors

Remy Stewart is a PhD candidate in the Department of Sociology at Cornell University. Chris Hess is an assistant professor in the Department of Sociology and Criminal Justice at Kennesaw State University. Ian Kennedy is a postdoctoral fellow in the Department of Sociology at Rice University. Kyle Crowder is a professor in the Department of Sociology at the University of Washington.

Appendix

Appendix Exhibit 1

Linear Probability Models of Move-In Fee Mentions Within Craigslist Ads

	Security Deposits	Application Fee	First or Last Month's Rent
Intercept	-0.093 (0.044)*	-0.017 (0.024)	0.002 (0.022)
Rent Asked (100s)	-0.004 (0.001)***	-0.001 (0.000)***	-0.001 (0.000)***
Square Footage (100s)	0.006 (0.001)***	0.002 (0.001)***	0.002 (0.000)***
Median Gross Rent (100s)	-0.003 (0.001)**	-0.002 (0.001)***	-0.001 (0.000)**
Share Single-Family Homes	0.001 (0.000)**	0.000 (0.000)	0.000 (0.000)
Share HU in 20+ Bldgs	-0.000 (0.000)	-0.000 (0.000)	-0.000 (0.000)*
Share Renter Occupied	0.001 (0.000)*	0.000 (0.000)	-0.000 (0.000)
Share Same Home Last Year	0.001 (0.000)*	0.000 (0.000)	0.000 (0.000)
Multiethnic	-0.017 (0.010)	-0.004 (0.005)	-0.005 (0.003)
Predominantly Asian/PI	0.034 (0.040)	0.013 (0.018)	-0.007 (0.009)
Predominantly Black	-0.031 (0.023)	-0.006 (0.010)	-0.003 (0.007)
Predominantly Latino	-0.032 (0.021)	-0.012 (0.007)	-0.005 (0.005)
Adjacent to Predominantly Black	0.030 (0.030)	0.024 (0.015)	0.021 (0.012)
Adjacent to Predominantly Latino	-0.019 (0.022)	-0.009 (0.008)	-0.011 (0.006)
Adjacent to Predominantly Asian/PI	-0.054 (0.067)	-0.036 (0.043)	-0.001 (0.010)
Adjacent to Multiethnic	-0.022 (0.017)	-0.010 (0.007)	-0.006 (0.006)
Adjacent to High Poverty	0.023 (0.008)**	0.010 (0.003)**	0.006 (0.002)**
High Poverty	0.012 (0.011)	0.016 (0.005)***	0.010 (0.003)***
Includes Metro Fixed Effects?	Yes	Yes	Yes
Num. obs.	1,285,094	1,285,094	1,285,094

HU = housing unit. PI = Pacific Islander.

*** $p < 0.001$. ** $p < 0.01$. * $p < 0.05$.

Note: Standard errors clustered by metropolitan area in parentheses.

Source: Authors' calculations based on data scraped from Craigslist and ACS 5-Year Public Use Microdata Sample

Appendix Exhibit 2

Logistic Regression Models of Move-in Fee Mentions Within Craigslist Ads

	Security Deposits	Application Fee	First or Last Month's Rent
Intercept	-3.465 (0.272)***	-4.192 (0.446)***	-4.680 (0.716)***
Rent Asked (100s)	-0.025 (0.005)***	-0.020 (0.004)***	-0.029 (0.008)***
Square Footage (100s)	0.037 (0.006)**	0.033 (0.007)***	0.049 (0.008)***
Median Gross Rent (100s)	-0.020 (0.006)**	-0.041 (0.009)***	-0.028 (0.011)**
Share Single-Family Homes	0.006 (0.002)**	0.003 (0.003)	0.002 (0.004)
Share HU in 20+ Bldgs	-0.001 (0.001)	-0.002 (0.002)	-0.007 (0.003)*
Share Renter Occupied	0.005 (0.002)*	0.001 (0.003)	-0.001 (0.004)
Share Same Home Last Year	0.007 (0.003)*	0.006 (0.003)	0.004 (0.006)
Multiethnic	-0.102 (0.062)	-0.061 (0.095)	-0.170 (0.099)
Predominantly Asian/PI	0.190 (0.213)	0.230 (0.342)	-0.268 (0.314)
Predominantly Black	-0.193 (0.173)	-0.113 (0.171)	-0.122 (0.219)
Predominantly Latino	-0.201 (0.138)	-0.188 (0.138)	-0.114 (0.177)
Adjacent to Predominantly Black	0.263 (0.224)	0.464 (0.243)	0.526 (0.326)
Adjacent to Predominantly Latino	-0.132 (0.148)	-0.125 (0.183)	-0.316 (0.237)
Adjacent to Predominantly Asian/PI	-0.291 (0.334)	-0.641 (0.713)	0.037 (0.343)
Adjacent to Multiethnic	-0.147 (0.116)	-0.217 (0.137)	-0.219 (0.207)
Adjacent to High Poverty	0.150 (0.048)**	0.178 (0.052)***	0.223 (0.073)**
High Poverty	0.074 (0.075)	0.271 (0.090)**	0.315 (0.093)***
Includes Metro Fixed Effects?	Yes	Yes	Yes
Num. obs.	1,285,094	1,285,094	1,285,094

HU = housing unit. PI = Pacific Islander.

*** $p < 0.001$. ** $p < 0.01$. * $p < 0.05$.

Note: Standard errors clustered by metropolitan area in parentheses.

Source: Authors' calculations based on data scraped from Craigslist and ACS 5-Year Public Use Microdata Sample

References

Adu, Providence, and Elizabeth C. Delmelle. 2022. "Spatial Variations in Exclusionary Criteria from Online Rental Advertisements," *The Professional Geographer*: 1–11.

Besbris, Max, John Kuk, Ann Owens, and Ariela Schachter. 2022. "Predatory Inclusion in the Market for Rental Housing: A Multicity Empirical Test," *Socius* 8: 1–16.

Besbris, Max, Ariela Schachter, and John Kuk. 2021. "The Unequal Availability of Rental Housing Information Across Neighborhoods," *Demography* 58 (4): 1197–1221.

Costa, Ana, Victoria Sass, Ian Kennedy, Roshni Roy, Rebecca J. Walter, Arthur Acolin, Kyle Crowder, Chris Hess, Alex Ramiller, and Sarah Chasins. 2021. "Toward a Cross-Platform Framework: Assessing the Comprehensiveness of Online Rental Listings," *Cityscape* 23 (2): 327–340.

Desmond, Matthew. 2016. *Evicted: Poverty and Profit in the American City*. New York: Crown Books.

Duke-Lucio, Joanna, Laura R. Peck, and Elizabeth A. Segal. 2010. "The Latent and Sequential Costs of Being Poor: An Exploration of Housing," *Poverty & Public Policy* 2 (2): 83-102.

Garcia, Manny, and Edward Berchick. 2021. *Renters: Results From the Zillow Consumer Housing Trends Report 2021*. Zillow Group Population Science. <https://www.zillow.com/research/renters-consumer-housing-trends-report-2021-29863/>.

Grimmer, Justin, Margaret E. Roberts, and Brandon M. Stewart. 2022. *Text as Data: A New Framework for Machine Learning and the Social Sciences*. Princeton, NJ: Princeton University Press.

Hangen, Forrest, and Daniel T. O'Brien. 2022. "The Choice to Discriminate: How Source of Income Discrimination Constrains Opportunity for Housing Choice Voucher Holders," *Urban Affairs Review* 1–25. <https://doi.org/10.1177/10780874221109591>.

Hess, Chris, Arthur Acolin, Rebecca Walter, Ian Kennedy, Sarah Chasins, and Kyle Crowder. 2021. "Searching for Housing in the Digital Age: Neighborhood Representation on Internet Rental Housing Platforms Across Space, Platform, and Metropolitan Segregation," *Environment and Planning A: Economy and Space* 53 (8): 2012–2032.

Hess, Chris, and Sarah E. Chasins. 2022. "Informing Housing Policy Through Web Automation: Lessons for Designing Programming Tools for Domain Experts," *CHI Conference on Human Factors in Computing Systems Extended Abstracts* 32:1–19.

Hess, Christian, Rebecca J. Walter, Arthur Acolin, and Sarah Chasins. 2019. "Comparing Small Area Fair Market Rents with Other Rental Measures Across Diverse Housing Markets," *Cityscape* 21 (3): 159.

Judkins, Marsha. 2020. "H.B. 211 Renter Expenses Disclosure Agreement." Utah State Legislature. <https://le.utah.gov/~2020/bills/static/HB0211.html>.

Kennedy, Ian, Chris Hess, Amandalynne Paullada, and Sarah Chasins. 2021. "Racialized Discourse in Seattle Rental Ad Text," *Social Forces* 99 (4): 1432–1456.

Korver-Glenn, Elizabeth. 2018. "Compounding Inequalities: How Racial Stereotypes and Discrimination Accumulate Across the Stages of Housing Exchange," *American Sociological Review* 83 (4): 627–56.

Krysan, Maria, and Kyle Crowder. 2017. *Cycles of Segregation: Social Processes and Residential Stratification*. New York: Russell Sage Foundation.

Logan, John R., and Charles Zhang. 2010. "Global Neighborhoods: New Pathways to Diversity and Separation," *American Journal of Sociology* 115 (4): 1069–1109.

Messing, Jill Theresa, Kristie A. Thomas, Allison Ward-Lasher, and Jessye Johnson. 2021. "Survivors Achieving Stable Housing: Implementation, Challenges, and Lessons Learned," *Social Work* 66 (1): 49–58.

Metzger, Molly W., Annah Bender, Alana Flowers, Vithya Murugan, and Divya Ravindranath. 2019. "Step by Step: Tenant Accounts of Securing and Maintaining Quality Housing with a Housing Choice Voucher," *Journal of Community Practice* 27 (1): 31–44.

Nelson, Laura. 2020. "Computational Grounded Theory: A Methodological Framework," *Sociological Methods & Research* 49 (1): 3–42.

Orians, Kelly Elizabeth. 2016. "'I'll Say I'm Home, I Won't Say I'm Free': Persistent Barriers to Housing, Employment, and Financial Security for Formerly Incarcerated People in Low-Income Communities of Color," *National Black Law Journal* 25 (1): 23–58.

Ramiller, Alex. 2022. "Displacement Through Development? Property Turnover and Eviction Risk in Seattle," *Urban Studies* 59 (6): 1148–1166.

Rosen, Eva. 2014. "Rigging the Rules of the Game: How Landlords Geographically Sort Low-Income Renters," *City & Community* 13 (4): 310–340.

Rosen, Eva, Philip M.E. Garboden, and Jennifer E. Cossyleon. 2021. "Racial Discrimination in Housing: How Landlords Use Algorithms and Home Visits to Screen Tenants," *American Sociological Review* 86 (5): 787–822.

Stewart-Cousins, Andrea. 2019. "Housing Stability and Tenant Protection Act of 2019." New York State Senate. <https://www.nysenate.gov/legislation/bills/2019/S6458>.

Tighe, J. Rosie, Megan E. Hatch, and Joseph Mead. 2017. "Source of Income Discrimination and Fair Housing Policy," *Journal of Planning Literature* 32 (1): 3–15.

U.S. Census Bureau. 2019. *American Housing Survey 2019 Public Use Files*. <https://www.census.gov/programs-surveys/ahs/data/2019/ahs-2019-public-use-file--puf-/ahs-2019-national-public-use-file--puf.html>.

U.S. Department of Housing and Urban Development. 2022. "Resident Characteristics Report (RCR)." https://www.hud.gov/program_offices/public_indian_housing/systems/pic/50058/rcr.

U.S. Department of Housing and Urban Development Office of Public and Indian Housing (HUD-PIH). 2022. "Notice PIH 2022-18 (HA): Use of Housing Choice Voucher (HCV) and Mainstream Voucher Administrative Fees for Other Expenses to Assist Families to Lease Units." <https://www.hud.gov/sites/dfiles/PIH/documents/PIH2022-18.pdf>.

Foreign Exchange

Foreign Exchange, a department of Cityscape, reports on what the U.S. Department of Housing and Urban Development's Office for International and Philanthropic Innovation has learned about new departures in housing and development policy in cities and suburbs throughout the world that might have value if applied in U.S. communities. If you have a recent research report or article of fewer than 2,000 words to share in a forthcoming issue of Cityscape, please send a one-paragraph abstract to Bradley.A.Weaver@hud.gov.

The Role of Forbearance in Sustaining Low-Income Homeownership: Evidence from Norway's Public Starter Mortgage Program

Anna Maria Santiago
Michigan State University

Kristin Aarland
Oslo Metropolitan University

Abstract

In the wake of the Global Financial Crisis of 2008 and, more recently, the COVID-19 pandemic, policymakers in the United States and Europe have been reevaluating how best to respond to unanticipated shocks that destabilize global economies and housing markets, which increase exposure to financial risks that trigger housing instability, evictions, forced short sales, or foreclosures, particularly among the most vulnerable populations in society. Lessons learned from the inadequacy of governmental response during the Global Financial Crisis to stave off foreclosures in the United States, the United Kingdom, and countries across Europe led to the timely implementation of broader national initiatives, such as expanded unemployment benefits, foreclosure moratoria, and the expanded use of mortgage forbearance to respond to the economic uncertainty associated with the COVID-19 pandemic. Early studies of the use of mortgage forbearance during COVID-19 suggest that these policies lessened the precarity of maintaining a foothold on the housing ladder while allaying concerns about widespread moral hazard. In addition, should the use of mortgage forbearance be limited to only global economic disasters or pandemics? An analysis of Norway's national Starter Mortgage Program, especially the

Abstract (continued)

role of local municipalities in the use of discretion, leniency, and forbearance, provides relevant insights for the design of mortgage programs that sustain low-income homeownership both in times of national economic growth, as well as during crises.

This article examines how municipal discretion, leniency, and forbearance in a public starter mortgage program post-mortgage origination help to sustain homeownership among vulnerable families and mitigate mortgage defaults that lead to forced short sales. Offering forbearance to vulnerable homeowners when it is needed post-origination supports the sustainability of low-income homeownership, does not produce widespread moral hazard, and protects both national and municipal financial investments in public mortgage programs.

Introduction

During the past 5 decades, expanding access to homeownership to lower income families has been the foundation of housing policy in many countries throughout North America and Europe (Belsky, Hebert, and Molinsky, 2014; Filandri and Olagnero, 2014; Kemp, 2000; Retsinas and Belsky, 2002). However, sustaining homeownership is less certain when financially vulnerable homeowners with limited financial resources are overexposed to personal setbacks and economic triggers that may lead to default. How to best support financially vulnerable families in sustaining homeownership continues to be heavily debated among scholars and policymakers alike. Recent global crises, such as the Global Financial Crisis in 2008 and the COVID-19 pandemic, further underscore the considerable risks to sustaining homeownership associated with the deteriorating economic positions of low-income families (Dewilde and De Decker, 2016; Farrell, Greig, and Zhao, 2020; Filandri and Bertonlini, 2016; Haffner et al., 2017; McCarthy, 2014; Stanga, Vlahu, and de Haan, 2018). Those crises also highlight the need for alternative approaches to default prevention (Albuquerque and Varadi, 2022; Farrell, Bhagat, and Zhao, 2018; Loewenstein and Njinju, 2022; Perlmeter, 2022).

This article contributes to this current debate by examining a nationwide, yet local municipality-run public mortgage program in Norway whose use of municipal discretion, leniency, and forbearance has enabled vulnerable families to sustain homeownership during periods of economic uncertainty. The article begins with a brief review of the literature on low-income homeownership policies and the extent to which foreclosure moratoria and forbearance mitigate loss and promote sustainability. Then, the context for low-income homeownership in Norway and a detailed description of the Starter Mortgage Program (Startlån) is provided. A summary of key program strategies and outcomes follows, including recent evidence indicative of the use of municipal discretion, leniency, and forbearance. The article concludes with a discussion of implications for housing policy and practice and the extent to which programs like the Starter Mortgage Program in Norway offer viable alternative means for supporting low-income homeownership.

Sustainable Low-Income Homeownership: Where Do We Go from Here?

During the past half century, housing policies promoting homeownership were extended to include ever lower-income families in the United States, the United Kingdom, Australia, and other European countries, underscoring the beliefs that (1) homeownership was the key to wealth generation in vulnerable families, and (2) wealth accumulation was inextricably linked to the continued duration of homeownership tenure (Belsky, Herbert, and Molinsky 2014; Doling and Elsinga, 2005; Filandri and Olagnero, 2014; Kemp, 2000; Jones et al., 2007; Norris, Coates, and Kane, 2007; Poggio, 2006; Retsinas and Belsky, 2002; Wainer and Zabel, 2019; Yates, 2003). However, those beliefs have been tempered by concerns about the sustainability of homeownership among vulnerable families (Bratt, 2008; Haffner et al., 2017; Mallach, 2011).

These concerns prompted numerous studies to identify factors mitigating the long-term sustainability of homeownership among low-income buyers (for reviews, see Gerlach-Kristen and Lyons, 2018; Jones and Sirmans, 2015; LaCour-Little, 2008; Quercia and Stegman, 1992; Tajaddini and Gholipour, 2017). Prior studies underscore the role of negative equity and underwater mortgages and adverse trigger events, such as prolonged spells of unemployment or illness, income loss, residential relocations, or marital disruptions in sparking mortgage arrears and the subsequent use of strategic defaults (Foote, Gerardi, and Willen, 2008, 2009; Goodman et al., 2010; Linn and Lyons, 2018; Ngene et al., 2016; Seiler, 2014). In addition, Elul and colleagues (2010) found that household factors such as high loan-to-value ratios, high credit card debt, and the extraction of any home equity contributed to household insolvency and declining homeownership sustainability. Further, McCann and O'Malley (2021) observed that homebuyers who obtained mortgage products such as low or no downpayment loans, adjustable-rate mortgages with balloon payments, and interest-only financing were more easily distressed by economic crises that, in turn, triggered short-term responses to sustain homeownership, such as interest-only payments, but did not provide sustainable, longer-term solutions.

More recently, attention has focused on the influence of global economic recessions that triggered the collapse of housing markets across North America and Europe in 2008 and a nascent literature examining the effects of the COVID-19 pandemic on the sustainability of homeownership, particularly among vulnerable homeowners (Belsky, Herbert, and Molinsky, 2014; Clark, 2013; Dettling and Lambie-Hanson, 2021; Farrell, Greig, and Zhao, 2020; Haughwout et al., 2020; Loewenstein and Njinju, 2022; Norris, Coates, and Kane, 2007; Perlmeter, 2022; Rohe and Lindblad, 2014; GAO, 2021). Recent policy studies note that the marked difference in mortgage delinquencies during the Global Financial Crisis (which were quite high) and the COVID-19 pandemic (which have been very low) were associated primarily with generous income support to households and the widespread availability of foreclosure moratoria and mortgage loan forbearance during the pandemic (Dettling and Lambie-Hanson, 2021; Loewenstein and Njinju, 2022). Although Farrell, Bhagat, and Zhao (2018) suggest that maintaining post-purchase savings buffers significantly decreased default rates, they note that mortgage payment reductions were important mechanisms to sustain homeownership, although access to and use of such reductions were more restricted. In addition, recent studies report that vulnerable homeowners with the greater financial

needs primarily used foreclosure moratoria and forbearance under the Coronavirus Aid, Relief, and Economic Security, or CARES, Act in the United States and offer little evidence suggesting widespread misuse (Farrell, Greig, and Zhao, 2020; Loewenstein and Njinju, 2022; GAO, 2021).

Nonetheless, limited attention has been devoted to how low-income homeowners have fared in other countries during these recent crises (Barbaglia, Manza, and Tosetti, 2021; Stanga, Vlahu, and de Haan, 2018). Most European countries, including Norway, do not forgive outstanding mortgage debt at time of foreclosure or forced sale (Barbaglia, Manzan, and Tosetti, 2021; Ghent and Kudlyak, 2011; Lambrecht, Perraudin, and Satchell, 2003). In countries where recourse laws diminish the likelihood of debt forgiveness for home mortgages, borrowers experiencing negative equity are more likely to go into short- and long-term arrears instead of foreclosure (Gerlach-Kristen and Lyons, 2018). When full-recourse mortgages are coupled with limited availability of social housing or private rental housing, or both, financiers and local governments are actively engaged in keeping vulnerable homeowners in their homes. *However, what strategies do they employ and when are they used?* Although the literature that examines municipal discretion affecting decision-making with social housing is sparse, even less is known about how local-level decision-making and discretion are employed in the development of strategies to sustain low-income homeownership (Aarland and Sørvoll, 2021; Grander, 2018; Krapp and Vaché, 2020).

Given the U.S. focus of most previous studies, Norway provides a new lens through which to examine the role of housing policy in sustaining low-income homeownership (Quercia, Freeman, and Ratcliffe, 2011; Rohe and Watson, 2007; Santiago and Leroux, 2022; Van Zandt and Rohe, 2006). Understanding whether low-income homeownership policy in other contexts improve outcomes for vulnerable families is vital as other countries shift toward market-based reforms of the housing sector that affect the well-being of households and the reproduction of housing inequality (Filandri and Olagnero, 2014; Kemp, 2000; Priemus and Dieleman, 2002; Toussaint et al., 2007). In contrast to countries like the United States and United Kingdom, serious and repeated mortgage arrears did not trigger immediate moves to foreclose or force a short sale by mortgage lenders in Norway in the years after the Global Financial Crisis or the start of the COVID-19 pandemic (NSHB, 2021). Furthermore, unlike the United States and Europe, where larger scale policy attempts at foreclosure mitigation and forbearance were implemented primarily to curtail the tide of mortgage delinquencies and evictions during the Global Financial Crisis and then COVID-19 pandemic, the Norwegian case provides evidence of the benefits of offering such strategies to vulnerable homeowners from the onset of homeownership tenure (Gerlach-Kristen and Lyons, 2018; McCann and O'Malley, 2021; McCarthy, 2014; Reid, Urban, and Collins, 2017; GAO, 2021).

Homeownership and the Housing Market in Norway

Similar to the United States, Norway has maintained a strong policy emphasis on promoting homeownership during the past 70 years and, since the late 1980s, has combined this ethos of homeownership with relatively unregulated housing markets (Aarland and Nordvik, 2010; Nordvik and Sørvoll, 2014; Stamsø, 2008, 2009; Torgersen, 1987). In contrast to other countries in Europe that expanded the social rental housing sector, Norwegian housing policy emphasized the extension of homeownership to low- and moderate-income households (Filandri and Bertolini, 2016; Jones et al., 2007; Stamsø, 2008, 2009). This policy emphasis on homeownership was

grounded in the belief among Norwegian policymakers that homeownership confers economic and social benefits far beyond rental housing, especially for children (NSHB, 2016). Unlike the United States, however, the low-income homeownership program in Norway operates within the context of a comprehensive cradle-to-grave welfare state that buffers against extreme economic shocks threatening the sustainability of homeownership among the country's most vulnerable families.

As in other countries touting the homeownership ethos, homeownership in Norway is considered a desirable tenure heralded as a tangible symbol of reaching adulthood and attaining middle-class status. However, the push to make homeownership available to a broad segment of the population in Norway hails from a very different ideological origin than that witnessed in many other countries in Europe (Doling and Ronald, 2010; Rolnik, 2013; Ronald, 2008). Post-World War II dominance of the Labor Party and its emphasis on the dignity of workers generated strong party opposition targeted toward predatory and exploitative landlords who had dominated the rental market during the first half of the 20th century. As Sørvoll (2009: 9) observes, "Every family should own their own home" became a mantra of the Labor Party platform from the mid-1950s onward. As a result of this push toward homeownership, three-fourths of Norwegian households are homeowners,¹ a figure that has remained fairly stable since 1990.²

Thus, the rental market plays a secondary and residual role in Norway. Developing a comprehensive rental sector has never been high on the political agenda because renting is regarded as an intermediate step between the parental home and homeownership or between owned homes (Sandlie and Sørvoll, 2017). The rental market is split between a relatively unregulated private rental market dominated by small-scale private landlords and a social housing sector that, at 5 percent of the total housing stock, is quite small compared with other northern European countries' and practices' strict socio-medical selection criteria. Overall, the rental sector does not cater to evolving needs of families during the various stages of a housing career (Bengtsson, Ruonavaara, and Sørvoll, 2017). These characteristics make it particularly challenging for families with children to secure stable and decent rental housing.

Social Policy and the (Lack of) a Right to Housing

Despite Norway's comprehensive cradle-to-grave welfare state, it should be noted that housing is regarded as a private matter and one that most people are expected to resolve on their own without government assistance. Consequently, housing has been labeled "the wobbly pillar" of the welfare state because of its reliance on private transactions in a relatively unregulated market and government assistance targeted only for vulnerable groups (Torgersen, 1987).

However, in accordance with The Law on Social Services (section 3 § 15),³ the local municipality must aid disadvantaged persons who, for economic, social, health, or other reasons, need assistance

¹ <https://www.ssb.no/en/statbank/table/11084>.

² The homeownership rate was measured at 80 percent in the 1990 census, 77 percent in both 2001 and 2011, and 76 percent in 2021 and includes the roughly 11 percent who own homes through housing cooperatives; see <https://www.ssb.no/en/bygg-bolig-og-eiendom/bolig-og-boforhold/statistikk/boforhold-registerbasert>.

³ Rundskriv til Lov om sosiale tjenester i NAV - Lovdata.

in securing adequate housing. Moreover, local social and welfare offices⁴ of the Norwegian Labour and Welfare Administration are obliged to provide temporary, emergency shelter to those unable to find it on their own or who are doubling up with others (Law on Social Services, section 4 § 27). Consistent with an overall strong child-centered focus in Norwegian social policy, meeting and safeguarding the needs of dependent children in the household is emphasized (Skevik, 2003).

Homeownership Experience in Norway

Connections to social welfare services may not overcome the precarity of homeownership tenure because financial capability remains one of the most important factors for sustaining homeownership over time. Indeed, persistently low levels of income and loose attachment to the labor market have been identified previously as major barriers to sustaining homeownership in Norway (Aarland and Nordvik, 2009). In addition, housing market trends in Norway have raised further concerns about financial stability. Jurgilas and Lansing (2019) suggest that the Norwegian housing market is highly vulnerable to economic shocks, noting the growing debt burdens relative to household income, high loan-to-value ratios, prevailing use of variable interest rates, coupled with expectations among Norwegians that home values will continue to rise and hence, produce high returns to housing investment. Indeed, as exhibit 1 shows, 90-day mortgage arrears in Norway during the period between 2008 and 2020 varied between 0.4 and 1.2 percent, substantially lower than those reported for the United States.

⁴ The Norwegian Labour and Welfare Administration (NAV) is the local social and welfare services office. NAV administers all social security and other welfare programs, and every municipality and city borough has a local NAV office that services their local population. In addition, about 100 state-level special NAV offices perform centralized tasks.

Exhibit 1

Percent of All Mortgages in 90-Day Arrears in Norway and the United States, 2008 to 2020

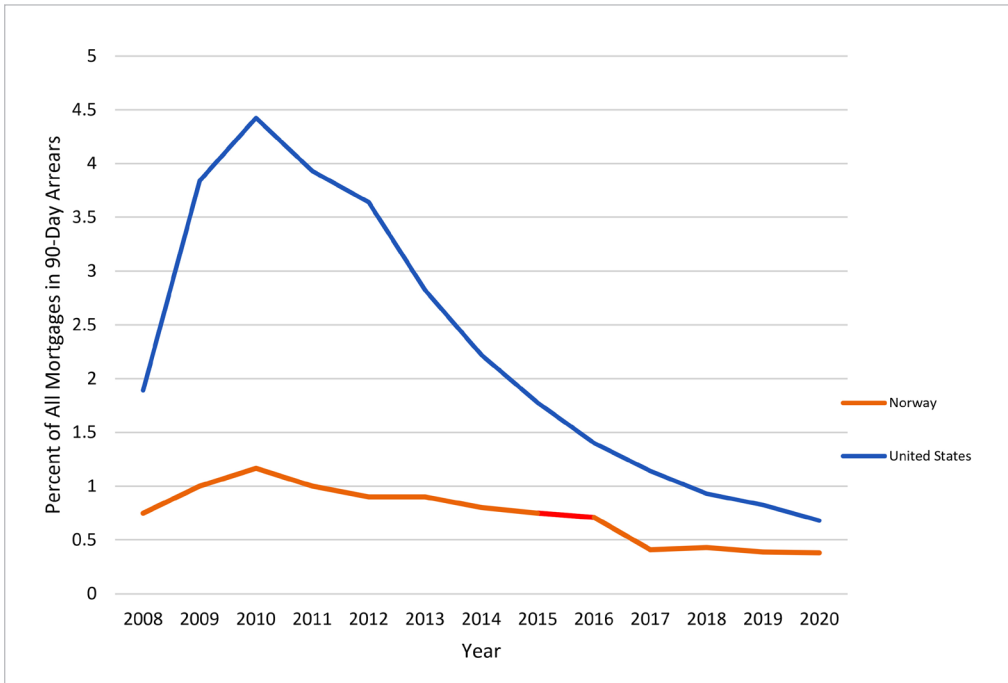

Sources: 2008–15—Financial Supervisory Authority of Norway. 2016. *Risk Outlook 2016*, figure 2.15; 2016–19—European Banking Authority. 2019. *EBA Report on NPLs: Progress Made and Challenges Ahead. NPL ratios by Households in Annex 6—NPL and FBL ratios by segment and country*. https://www.eba.europa.eu/sites/default/documents/files/document_library/Risk%20Analysis%20and%20Data/Risk%20Assessment%20Reports/2019/Final%20EBA%20Report%20on%20NPLs-for%20publication_final.pdf; 2020—The Financial Supervisory Authority of Norway. 2022. *Tap og mislighold i kredittinstitusjoner*. 2021—Losses and nonperforming loans in credit institutions. Quarterly figures for large banks in table 2.4 have been averaged for 2020. https://www.finanstilsynet.no/contentassets/829e13ed2b9c45f3b86beff10654d873/tap_mislighold_kredittinstitusjoner_31mars2021.pdf; U.S. Consumer Finance Protection Bureau. *Mortgages 90 or more days delinquent*. <https://www.consumerfinance.gov/data-research/mortgage-performance-trends/mortgages-90-or-more-days-delinquent/>

Unlike other countries that have nonrecourse laws, homeowners in Norway do not lose their debt obligations if they can no longer sustain homeownership and default on their mortgages. Debtors are permanently obligated to repay mortgage debt unless the courts grant a debt settlement. Recent increases in forced sales court filings reflect a growing debt vulnerability among households in Norway. However, sustainability of household debt burden during the longer term remains heavily dependent on the expectations of continued growth in house prices, with lenders more likely to refinance loans than to foreclose (see discussion in Grindaker, 2013). Trends during the period between 2008 and 2021 underscore that optimism, because the percentage of forced residential property sales that the courts executed hovered around 4 percent (exhibit 2).

Exhibit 2

Percent of Forced Sales Among Residential Property Transfers, Norway 2008–21

Year	Total Residential Property Transfers (N)	Forced Sales of Properties Remanded to the Courts (N)	Forced Sales Executed by the Courts (N)	Percent of Total Forced Sales Executed by Courts (%)
2008	101,375	10,602	391	3.7
2009	101,536	12,765	486	3.8
2010	108,476	13,844	704	5.1
2011	115,243	16,717	687	4.1
2012	120,529	15,821	708	4.5
2013	117,909	16,924	609	3.6
2014	122,324	17,466	613	3.5
2015	124,721	17,491	680	3.9
2016	122,958	17,371	626	3.6
2017	123,755	17,054	624	3.7
2018	126,782	17,755	657	3.7
2019	129,793	15,443	725	4.7
2020	137,930	15,949	765	4.8
2021	142,347	15,653	748	4.8
Totals	1,695,678	220,855	9,023	4.1

Notes: Figures have been annualized and do not include housing cooperative units. Remanded figures include all properties, residential, commercial and vacation homes, and built and undeveloped plots. Executed figures include only residential built-up properties.

Sources: Statistics Norway Table 08948—Transfers of real property, by type of transfer and type of property 2000K1–2022K1 (<https://www.ssb.no/en/statbank/table/08948>); Statistics Norway Table 07218—Bankruptcies, forced sales, and registered execution proceedings 1995M01–2022M09 (<https://www.ssb.no/en/statbank/table/07218>)

Startlån—Norway’s Starter Mortgage Program

In 2003, the Norwegian State Housing Bank introduced the Starter Mortgage Program, or Startlån, as a national homeownership program administered at the local municipality level to support disadvantaged households (Sørvoll, 2011). Nearly 2 decades later, local municipalities have originated approximately 149,000 Startlån mortgages,⁵ representing about 3 percent of all mortgages originated in Norway annually (NSHB, 2014). Since 2010, roughly one-half of all starter mortgages have been awarded to families with children, consistent with the explicit prioritization of families with children in Norwegian state housing strategies 2014–20 and 2021–24, respectively (Departementene, 2014; Kommunal- og moderniseringsdepartementet, 2020).

Several features define the Starter Mortgage Program. First, starter mortgages are exempt from some underwriting guidelines and mortgage regulations issued by The Financial Supervisory Authority of Norway. This exemption enables program participants to carry higher loan-to-value and debt-to-income ratios than regular mortgagors. Nonetheless, municipalities are still obligated to thoroughly scrutinize applicants’ creditworthiness and have a *duty to dissuade* potential homebuyers from taking on excessive financial obligations.⁶ Prior to purchase, all applicants are subject to a

⁵ <https://statistikk.husbanken.no/lan/startlan>.

⁶ Law on financial agreements, § 47. Note that the applicant may still take out the loan even though they are advised against it.

thorough financial assessment and are informed about the financial risks associated with taking out a starter mortgage. Second, interest rates are set centrally and do not reflect borrowers' elevated risk profiles. Instead, the program has historically offered below-market rate mortgages to all approved applicants.⁷ Third, individual municipalities hold starter mortgages, thereby exposing municipalities to considerable housing market risk in the event of an economic downturn.⁸ Fourth, considerable variation exists across municipalities in the fraction of the mortgage that is derived from the Starter Mortgage Program. Although the program provides 100 percent of the total mortgage for the most vulnerable borrowers, the loans may serve as second liens for borrowers who qualified for partial financing from other lenders, but the loan amounts were insufficient to originate the mortgage.

Together, these expectations for participants and municipalities imply that the financial incentives for sustaining homeownership over time are closely aligned between the mortgage holder and the municipality as the mortgage issuer. Further, their financial stake and the social profile of the Starter Mortgage Program give municipalities strong incentives to closely screen their applicants and, when appropriate, connect them to other social welfare services aimed at stabilizing borrower finances and ensuring sustainability of their mortgages.⁹ Nevertheless, such prepurchase counseling is highly individualized to the borrowers and tailored to their specific needs. Moreover, prepurchase homeownership counseling or other forms of homebuyer readiness preparation activities vary widely across municipalities; 4 out of 10 municipalities do not offer such activities at all (Astrup et al., 2015).

Once borrowers are in the program, municipalities receive regular mortgage servicing reports, particularly about late payments, on a regular basis. Caseworkers and mortgage servicers engage with delinquent mortgagors to resolve payment difficulties and connect them to social welfare services when required (Astrup et al., 2015). Loss mitigation extends to repeated delinquencies during the course of the mortgage, underscoring the ability of the municipality to offer forbearance and use discretion in determining whether and when to remand a delinquent mortgage to foreclosure or forced short sale. Coupled with post-purchase add-on services, such transmission of “soft” information, both during the application process and through ongoing contact between mortgagors and lenders, has been shown to lower the probability of mortgage delinquency and default among lower income homebuyers in the United States (Ergungor and Moulton, 2014; Hembre, Moulton, and Record, 2021; Moulton et al., 2015; Santiago and Leroux, 2022).

As exhibit 3 shows, financial losses in the Starter Mortgage Program have been very low to date, hovering between 0.03 and 0.06 percent of end-of-year outstanding debt from 2013 to 2021 (NSHB, 2019, 2021). However, uninterrupted housing price growth since the start of the program has enabled municipalities to recover outstanding debt even in the case of a forced sale, potentially concealing any repayment problems. Nonetheless, starter loan performance is better than that

⁷ The interest rate setting procedure for the State Housing Bank loan programs mimics those of the State Educational Loan Fund (student loans) and The Norwegian Public Service Pension Fund (mortgages for public sector employees). In addition, municipalities are allowed a 0.25 percentage point markup to cover their administrative costs.

⁸ Municipalities are fiscally responsible for the first 25 percent of any realized losses, whereas the central government will absorb any additional losses.

⁹ See Aarland (2012), Astrup and Aarland (2013), and Astrup et al. (2015) for details.

reported for mortgage loans held during the same period within the larger population. According to the Financial Supervisory Authority of Norway (2022), bank losses on personal loan portfolios ranged from 0.01 to 0.17. Nevertheless, whereas most personal loans are home mortgages, 3 to 4 percent are loans secured against other assets and unsecured loans. During normal times, the losses on consumer loans (that is, unsecured loans) are 10 to 20 times higher than other loans to households, primarily mortgages (Financial Supervisory Authority of Norway, 2022).

Exhibit 3

Municipal and State Losses from the Starter Mortgage Program

Year	Municipal Losses Number of Loans	Municipal Losses (in Millions NOK)	State Housing Bank Losses (in Millions NOK)	Total Losses (in Millions NOK)	Value of Total Stock of Starter Mortgage Program 12/31 (Thousands of NOK)	Combined Municipal and State Losses as Proportion of Total Value	Commercial Banks' Losses on Personal Loans
2013	111	13.9	5.8	19.7	38,397,025	0.051	0.057
2014	99	12.8	6.0	18.8	42,130,293	0.045	0.040
2015	78	10.3	5.7	16.0	45,288,554	0.035	0.001
2016	93	10.9	5.7	16.6	47,972,709	0.035	0.043
2017	76	8.5	5.4	13.9	51,300,000	0.027	0.074
2018*		23.4	6.8	30.2	51,300,000	0.059	0.068
2019	116	15.3	5.9	21.2	62,500,000	0.034	0.154
2020	141	22.4	8.8	31.2	58,312,000	0.054	0.147
2021	123	31.1	8.4	39.9	80,000,000	0.050	0.174

NOK = Norwegian Kroner.

* Number of losses not available for 2018.

Notes: The value of the kroner relative to the U.S. dollar (USD) has varied considerably during our study period. \$1USD = 5.88NOK (2013) to 8.60NOK in 2021. https://www.norges-bank.no/en/topics/Statistics/exchange_rates/?tab=currency&id=USD. The figures from 2020 and 2021 include only the loan portfolio managed by Lindorff, or Intrum (the largest mortgage service provider, servicing about 75 percent of the loan portfolio).

Sources: 2012–19 Norwegian State Housing Bank Annual Report 2019, Appendix 2 Analysis of Starter Mortgages, Table 13, p 108 for losses; Norwegian State Housing Bank Annual Report 2021, Appendix 2 Analysis of Starter Mortgages, Table 15, p 153; Stock of Starter Mortgages as of December 31 from the respective annual reports; Financial Supervisory Authority of Norway (2022) Risk Outlook 2022, Data for figure 5.9

The existence and local operation of the Starter Mortgage Program must be understood in the context of legal obligations municipalities have toward their citizens. In contrast to the United States, municipalities in Norway have a general obligation to assist vulnerable groups in procuring housing and a statutory obligation to provide emergency shelter (Law on Social Services, section 4 § 27).¹⁰ The starter mortgage constitutes an integral part of the municipal toolkit for helping vulnerable families attain stable housing. Similar to public housing authorities in the United States, Norwegian municipalities may provide social housing units, housing allowances, financial advisory services,¹¹ emergency cash assistance, and other supportive services to vulnerable families at their discretion. When homeownership is successful, it is widely regarded as the most desirable outcome for the families who attain adequate and stable housing, as well as the longer term opportunity for

¹⁰ See <https://lovdata.no/nav/runtskriv/r35-00#ref/lov/2009-12-18-131/§15>.

¹¹ According to the Law on Social Services Ch. 4 § 17, financial advice is one of the services that the municipality is mandated to offer their inhabitants.

accumulating home equity and for the local municipality, which is likely to save money on other and more costly housing services such as social housing and emergency shelter.

Considering these safeguards, approximately 7 percent of Norwegian homeowners in the Starter Mortgage Program experienced a serious mortgage delinquency during the first 48 months of homeownership (exhibit 4). In recent work by Aarland and Santiago (forthcoming), mortgage arrears were greater among Starter Mortgage Program families who were larger and more likely to be headed by borrowers who were younger, male, sole borrowers, were native Norwegian, and had lower levels of education and savings but higher consumer debt. Higher risk of falling into arrears also was associated with higher loan-to-value ratios or interest-only mortgages at the time of origination. They found that, despite repeated delinquencies, borrowers in the study retained homeownership instead of being remanded to the courts to execute forced home sales. At the same time, accrued debt is not forgiven; rather, borrowers are given the chance to repay as evidenced by mortgage payment patterns. Results reinforce earlier survey and qualitative interview findings, suggesting that municipalities intervened and exerted significant discretion and leniency with vulnerable borrowers struggling to meet mortgage payments using forbearance (for example, Astrup et al., 2015).

Exhibit 4

Kaplan-Meier Survival Curve for 90-Day Late Starter Mortgage Program Payments During the First 3 Calendar Years After Mortgage Origination

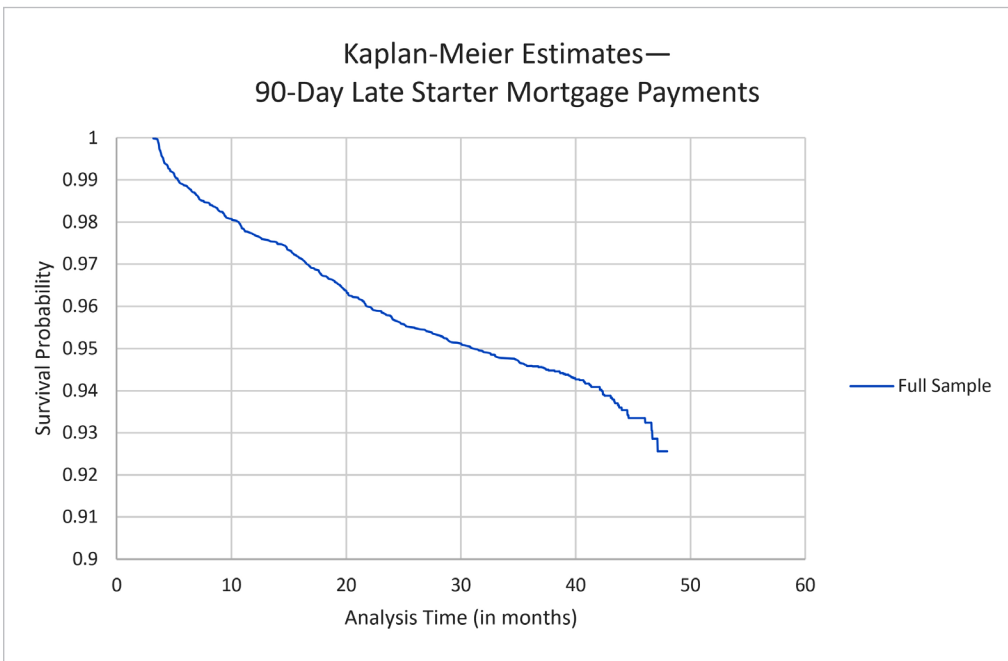

Source: Author's calculations using unpublished Starter Mortgage Program project data for the period between 2006 and 2016; see Aarland and Santiago (forthcoming)

National data for all Starter Mortgage Program loans support this observation. As exhibit 5 shows, between 2015 and 2020, only 2.2 percent of all Starter Mortgage Program loans originated in Norway were ever sent to collection, 0.5 percent were remanded to the courts in forced sales petitions, and 5.2 percent ever sent to collection were executed as forced sales (NSHB, 2021). The small fraction of delinquent mortgages that were ever adjudicated in the courts as forced sales suggests that municipalities offered leniency or forbearance to program participants who found themselves in financial difficulties. Previous surveys of municipal caseworkers support this assertion, underscoring that municipalities were well informed about who had fallen into mortgage arrears and were actively engaged in working with program participants to stabilize their financial situations (Astrup et al., 2015).

Policy Implications

The Starter Mortgage Program fills an important niche within the Norwegian housing market by offering vulnerable families the opportunity to purchase their homes where other housing options are lacking. Consistent with previous studies of low-income homeownership programs, a small but nontrivial number of program participants encounter difficulty paying their mortgages on time (Hembre, Moulton, and Record, 2021; Santiago and Leroux, 2022). Mortgage arrears were common. Nearly 7 percent of Starter Mortgage Program homeowners were seriously delinquent (90 or more days late) in making their monthly mortgage payments during the early years of homeownership, and among those who were ever late, nearly one-fourth made recurring late payments (Aarland and Santiago, forthcoming). These findings suggest that a fraction of vulnerable households participating in the Starter Mortgage Program may rely on municipal discretion and support to sustain homeownership. The findings also offer a more expansive view of homeownership sustainability because they indicate that vulnerable homeowners can maintain homeownership given the availability of ongoing support post-origination when needed.

Local municipalities yield considerable control regarding the implementation and management of the Starter Mortgage Program. Given the vulnerability and higher risks associated with the target population served by the program, there appears to be recognition that some level of serious mortgage arrears may be inevitable for a small fraction of program participants, and municipalities need to exercise sound judgment in addressing them when they arise. This leniency is evident in the tolerance for recurring late payments, including shifts to serious delinquencies, and the small fractions of these delinquencies that are ever remanded to and executed by the Norwegian courts as forced sales. This practice suggests that forced sales do not have to be the end result of mortgage arrears and that municipal discretion, leniency, and forbearance play important roles in stemming the tide of forced sales. The Norwegian case provides a sharp contrast to other countries, such as the United States, where forbearance (outside of the COVID-19 pandemic) has been used sparingly (Farrell, Greig, and Zhao, 2020; Loewenstein and Njinju, 2022). Moreover, given the small fraction of homebuyers who have repeated delinquencies in the program, it appears that any leniency or forbearance employed by municipal caseworkers tends to serve families in financial need without prompting widespread moral hazard.

Exhibit 5

Description of Startlån Mortgage Portfolio and Incidence of Collections and Forced Sales 2015–21

Year	Number of Municipalities in Portfolio	Active Startlån Mortgages in Portfolio as of December 31	Total Startlån Mortgage Debt as of December 31 (NOK)	Average Repayment Time in Years (Contract)	Startlån Mortgages Sent to Collection (N)	Startlån Mortgages Sent to Collection as Share of Active Loans	Startlån Mortgages Petitioned Forced Sales (N)	Startlån Mortgages Executed Forced Sales (N)	Executed Forced Sales as Share of Loans Sent to Collection (%)
2015	293	51,882	29,839,537,348	23.98	1243	2.4%	256	34	2.7
2016	318	51,681	31,895,850,618	24.63	1260	2.4%	364	57	4.5
2017	318	51,799	35,268,643,487	25.45	1133	2.2%	248	80	7.1
2018	315	52,365	39,476,462,441	26.35	1134	2.2%	282	74	6.5
2019	318	53,798	45,023,825,069	27.22	1078	2.0%	265	44	4.1
2020	278	59,913	56,054,025,455	28.06	1262	2.1%	266	5	0.4
2021	282	60,748	62,981,721,660	28.97	888	1.5%	222	125	14.1
Totals					7998	2.2%	1903	419	5.2

Notes: The figures are based on data from the main mortgage service provider Intrum (formerly Lindorff) that has a large segment of the market (282 of 356 municipalities, but a much larger share in terms of loans as most of the largest municipalities have outsourced the mortgage servicing to this company). Nearly 75 percent of all Startlån loans are serviced by Intrum.

Source: Norwegian State Housing Bank, Annual Report 2021, Appendix 2, Table 14

Astrup and colleagues (2015) conducted qualitative and survey work that offered reasons as to why this approach may be so in Norway. Given the mandate of the Starter Mortgage Program to facilitate homeownership among financially vulnerable families, local municipalities are obligated to support the national housing policy encouraging homeownership, support disadvantaged homeowners in sustaining homeownership, and fulfill statutory obligations to provide for the safety and well-being of children. This mandate is consistent with national policies and the larger social welfare system in Norway that supports children (Skevik, 2003).

As others have previously emphasized, low-income homeownership programs, like the Starter Mortgage Program, must enable households to make the *transition* to homeownership as well as provide wrap-around services aimed at *sustaining* homeownership (Bratt, 2008; Haffner et al., 2017; Mallach, 2011). Such services typically include pre- and post-purchase counseling and access to emergency cash funds for home repairs or other unexpected expenses (Mallach, 2011; Santiago and Leroux, 2022). Prior qualitative studies from Norway report that Starter Mortgage Program borrowers have access to post-origination counseling and emergency cash assistance (Astrup and Aarland, 2013; Astrup et al., 2015). Nonetheless, considerable discretion is allowed at the municipality level as to the availability of such assistance and to whom these services are offered. Moreover, these studies indicate that there is considerable discretion among municipal caseworkers in the use of leniency or forbearance in deciding when late payments occur and in caseworker willingness to seek alternative solutions to foreclosures when borrowers fall behind on their mortgage payments.

This pragmatic approach to late mortgage payments at the municipality level is likely coupled with the reality that private rental and social housing stock in Norway is quite limited, which has implications for other countries—such as the United States and Europe—that are experiencing decreasing supplies of and increasing demands for affordable housing. In contrast to private lenders, the municipality retains responsibility for providing housing for vulnerable households if they move to foreclose. When confronted with few options to meet the long-term housing needs of vulnerable families, keeping these families in units that they have purchased not only contributes to residential stability important for children’s health and well-being, but also reduces municipal costs associated with providing emergency housing and services. Furthermore, the high costs associated with adjudicating mortgage delinquencies, defaults, foreclosures, or short sales in municipal or state courts may foster more cost-effective and efficient alternative solutions. By working with families facing financial difficulties rather than moving to foreclose and force evictions, local governments can stem the long-term and cascading effects associated with housing instability and homelessness, particularly for vulnerable children.

Conclusions

Several powerful lessons can be learned from this example from Norway. First, national programs to promote low-income homeownership with high levels of local control can be successful tools in the provision of housing for the most disadvantaged members of society. The Starter Mortgage Program in Norway has served an important niche of the housing market, which may be applicable to other contexts attempting to serve specific target populations that experience housing insecurity.

Second, municipalities can mitigate the likelihood of converting mortgage delinquencies to defaults and forced sales by preemptively providing financial and social support to those most in need, as well as connecting vulnerable families to other social welfare resources available to them. Keeping vulnerable families stably housed addresses other constraints imposed on municipalities by the limited supply of social housing or private rental housing and the government mandate to mitigate housing precarity. Third, given continued volatility in the macroeconomic climate within countries and within the larger global economy, such as the current crisis associated with the COVID-19 pandemic, more measured responses to mortgage delinquencies that include options like current eviction and foreclosure moratoria, forbearance, loan modifications, or refinancing may be more fruitful policies that not only protect the most vulnerable members of society but lay the foundation for economic recovery.

Acknowledgments

Funding from the Norwegian State Housing Bank and the Norwegian Research Council Grant No. 258923 is gratefully acknowledged.

Authors

Anna Maria Santiago is a Professor of Community Development in the School of Social Work at Michigan State University in East Lansing, Michigan. santia63@msu.edu.

Kristin Aarland is a Senior Researcher in NOVA/Norwegian Social Research at the Oslo Metropolitan University. kraa@oslomet.no.

References

Aarland, Kristin, 2012. *Eieretablering Blant Hushold med Lave Inntekter (Homeownership Entry Among Low-Income Households)*. Oslo, Norway: Norwegian Social Research.

Aarland, Kristin, and Viggo Nordvik. 2010. "Eierlinjen i Norsk Boligpolitikk – Tar Boligeiere på seg for Stor Risiko? (The Ownership Line in Norwegian Housing Policy: Do Homeowners Take on too Great a Risk?)" *Økonomi & Politik* 83 (1): 51–65.

———. 2009. "On the Path of Homeownership: Money, Family Composition and Low-Income Households," *Housing Studies* 24 (1): 81–101.

Aarland, Kristin, and Anna Maria Santiago. Forthcoming. "Staying Afloat or Going Under: Mortgage Arrears in Norway's Starter Mortgage Program."

Aarland, Kristin, and Jardar Sørvoll. 2021. *Norsk Boligpolitikk i Internasjonalt Perspektiv (Norwegian Housing Policy in an International Perspective)*. Oslo, Norway: Norwegian Social Research.

Albuquerque, Bruno, and Alexandra Varadi. 2022. *Consumption Effects of Mortgage Payment Holidays: Evidence during the COVID-19 Pandemic*. Working paper 2022–044. Washington, DC: International Monetary Fund. <https://doi.org/10.5089/9798400203107.001>.

Astrup, Kim C., and Kristin Aarland. 2013. *Økonomisk Risiko og Boligeie (Financial Risk and Homeownership)*. NIBR-report 2013:28. https://www.regjeringen.no/globalassets/upload/kmd/boby/okonomisk_risiko_og_boligeie_nibr.pdf?id=2209622.

Astrup, Kim C., Lars C. Monkerud, Marit Ekne Ruud, and Kristin Aarland. 2015. *Kommunenes Praktisering av Startlånsordningen – Effekter av Den Nye Forskriften (Municipal Starter Mortgage Practices – Effects of the New Regulation)*. NIBR-report 2015:27. <https://kudos.dfo.no/dokument/kommunenes-praktisering-av-startlaansordningen-effekter-av-den-nye-forskriften/evalueringsportalen=1>.

Barbaglia, Luca, Sebastiano Manzan, and Elisa Tosetti. 2021. “Forecasting Loan Default in Europe with Machine Learning,” *Journal of Financial Econometrics* 1–28. doi:10.1093/jfinc/ebab010.

Belsky, Eric, Chris Herbert, and Jennifer Molinsky. 2014. *Homeownership Built to Last: Balancing Access, Affordability, and Risk After the Housing Crisis*. Washington, DC: Brookings Institution Press and Harvard University, Joint Center for Housing Studies.

Bengtsson, Bo, Hannu Ruonavaara, and Jardar Sørvoll. 2017. “Homeownership, Housing Policy and Path Dependence in Finland, Norway and Sweden.” In *Housing Wealth and Welfare*, edited by Caroline Dewilde and Ronald, Richard. Northampton, MA: Elgar Publishing: 60–84. <https://doi.org/10.4337/9781785360961>.

Bratt, Rachel G. 2008. “Homeownership as Social Policy in the U.S.: Risk and Responsibility After the Subprime Crisis.” Conference proceedings, Building on Homeownership: Housing Policies and Social Strategies. <http://resolver.tudelft.nl/uuid:97793be3-e958-430e-9f0e-ecff4d314e1b>.

Clark, William A. V. 2013. “The Aftermath of the General Financial Crisis for the Ownership Society: What Happened to Low-Income Homeowners in the United States?” *International Journal of Housing Policy* 13 (3): 227–246.

Departementene. 2014. *Bolig for Velferd: Nasjonal Strategi for Boligsosialt Arbeid (2014–2020) (Housing for Welfare: National Strategy for Housing and Support Services [2014–2020])*. https://www.regjeringen.no/globalassets/upload/kmd/boby/nasjonal_strategi_boligsosialt_arbeid.pdf.

Detting, Lisa J., and Lauren Lambie-Hanson. 2021. *Why is the Default Rate so Low? How Economic Conditions and Public Policies Have Shaped Mortgage and Auto Delinquencies During the COVID-19 Pandemic*. Washington, DC: Board of Governors of the Federal Reserve System. <https://doi.org/10.17016/2380-7172.2854>.

Dewilde, Caroline, and Pascal De Decker. 2016. “Changing Inequalities in Housing Outcomes Across Western Europe,” *Housing, Theory and Society* 33 (2): 121–161.

Doling, John, and Marja Elsinga. 2005. *Homeownership: Getting in, Getting from, Getting out, Part I*. Amsterdam, Netherlands: Delft University Press.

Doling, John, and Richard Ronald. 2010. "Homeownership and Asset-Based Welfare," *Journal of Housing and the Built Environment* 25 (2): 165–173.

Elul, Ronel, Nicholas S. Souleles, Souphala Chomsisengphet, Dennis Glennon, and Robert Hunt. 2010. "What 'Triggers' Mortgage Default?" *American Economic Review* 100 (2): 490–494. doi: 10.1257/aer.100.2.490.

Ergungor, O. Emre, and Stephanie Moulton. 2014. "Beyond the Transaction: Banks and Mortgage Default of Low-Income Homebuyers," *Journal of Money, Credit and Banking* 46 (8): 1721–1752.

Farrell, Diana, Kanav Bhagat, and Chen Zhao. 2018. *Falling Behind: Bank Data on the Role of Income and Savings in Mortgage Default*. JPMorgan Chase Institute. <https://www.jpmorganchase.com/content/dam/jpmc/jpmorgan-chase-and-co/institute/pdf/insight-income-shocks-mortgage-default.pdf>.

Farrell, Diana, Fiona Greig, and Chen Zhao. 2020. *Did Mortgage Forbearance Reach the Right Homeowners? Income and Liquid Assets Trends for Homeowners During the COVID-19 Pandemic*. JPMorgan Chase Institute. <https://doi.org/10.2139/ssrn.3742332>.

Filandri, Marianna, and S. Bertolini. 2016. "Young People and Home Ownership in Europe," *International Journal of Housing Policy* 16 (2): 144–164.

Filandri, Marianna, and Manuela Olagnero. 2014. "Housing Inequality and Social Class in Europe," *Housing Studies* 29 (7): 977–993.

Financial Supervisory Authority of Norway. 2022. "Risk Outlook June 2022." <https://www.finanstilsynet.no/en/publications/risk-outlook-reports/>.

Foote, Christopher, Kristopher Gerardi, and Paul Willen. 2009. "Reducing Foreclosures: No Easy Answers," *NBER Macroeconomics Annual* 24 (1): 89–138.

———. 2008. "Negative Equity and Foreclosure: Theory and Evidence," *Journal of Urban Economics* 64 (2): 234–245.

Gerlach-Kristen, Petra, and Seán Lyons. 2018. "Determinants of Mortgage Arrears in Europe: Evidence from Household Microdata," *International Journal of Housing Policy* 18 (4): 545–567.

Ghent, Andra C., and Marianna Kudlyak. 2011. "Recourse and Residential Mortgage Default: Evidence from U.S. States," *The Review of Financial Studies* 24 (9): 3139–3186.

Goodman, Laurie S., Roger Ashworth, Brian Landy, and Ke Yin. 2010. "Negative Equity Trumps Unemployment in Predicting Defaults," *The Journal of Fixed Income* 19 (4): 67–72.

Grander, Martin. 2018. "For the Benefit of Everyone?: Explaining the Significance of Swedish Public Housing for Urban Housing Inequality." Ph.D. diss., Department of Urban Studies, Faculty of Culture and Society, University of Malmö. <http://www.diva-portal.org/smash/record.jsf?pid=diva2%3A1404361&dsid=898>.

Grindaker, Morten H. 2013. "The Impact of Household Leverage on Mortgage Foreclosures in Norway: A Threat to Stability?" Master's thesis, Department of Economics, University of Oslo.

Haffner, Marietta E. A., Rachel Ong, Susan J. Smith, and Gavin A. Wood. 2017. "The Edges of Home Ownership—the Borders of Sustainability," *International Journal of Housing Policy* 17 (2): 169–176. <https://www.tandfonline.com/doi/pdf/10.1080/19491247.2017.1289717?>

Haughwout, Andrew, Donghoon Lee, Joelle Scally, and Wilbert van der Klaauw. 2020. "Following Borrowers through Forbearance," *Liberty Street Economics* blog. <https://libertystreeteconomics.newyorkfed.org/2020/11/following-borrowers-through-forbearance.html>.

Hembre, Erik, Stephanie Moulton, and Matthew Record. 2021. "Low-Income Homeownership and the Role of State Subsidies: A Comparative Analysis of Mortgage Outcomes," *Journal of Policy Analysis and Management* 40 (1): 78–106.

Jones, Anwen, Marja Elsinga, Deborah Quilgars, and Janneke Toussaint. 2007. "Home Owners' Perceptions of and Responses to Risk," *European Journal of Housing Policy* 7 (2): 129–150. doi: 10.1080/14616710701308539.

Jones, Timothy, and G. Stacy Sirmans. 2015. "The Underlying Determinants of Mortgage Default," *Journal of Real Estate Literature* 23 (2): 167–205.

Jurgilas, Marius, and Kevin J. Lansing. 2019. *Housing Bubbles and Homeownership Returns*. San Francisco: Federal Reserve Bank of San Francisco. <https://www.frbsf.org/economic-research/files/el2012-19.pdf>.

Kemp, Peter. 2000. "Housing Benefit and Welfare Retrenchment in Britain," *Journal of Social Policy* 29 (2): 263–279.

Kommunal- og moderniseringsdepartementet. 2020. *Alle Trenger et Trygt Hjem. Nasjonal Strategi for den Sosiale Boligpolitikken (2021–2024) (Everyone Needs a Safe Home. National Strategy for Social Housing Policy [2021–2024])*. <https://www.regjeringen.no/contentassets/c2d6de6c12d5484495d4ddeb7d103ad5/oppdatert-versjon-alle-trenger-en-nytt-hjem.pdf>.

Krapp, Max-Christopher, and Martin Vaché. 2020. *Housing Policies in the European Union*. Berlin, Germany: Institute for Housing and Environment. https://www.die-wohnraumoffensive.de/fileadmin/user_upload/aktivitaeten/veranstaltungen/Housing-Policies-in-Europe_Conference-Version.pdf.

LaCour-Little, Michael. 2008. "Mortgage Termination Risk: A Review of the Recent Literature," *Journal of Real Estate Literature* 16 (3): 297–326.

Lambrecht, Bart, William Perraudin, and Stephen Satchell. 2003. "Mortgage Default and Possession Under Recourse: A Competing Hazards Approach," *Journal of Money, Credit and Banking* 35 (3): 425–442.

Linn, Andrew, and Ronan C. Lyons. 2018. *The Triple Trigger? Negative Equity, Income Shocks and Institutions as Determinants of Mortgage Default*. Working paper 0718. Dublin, Ireland: Trinity College, Department of Economics.

Loewenstein, Lara, and Bezakeng Njinju. 2022. *Mortgage Borrowers' Use of COVID-19 Forbearance Programs*. Federal Reserve Bank of Cleveland. <https://www.clevelandfed.org/en/newsroom-and-events/publications/economic-commentary/2022-economic-commentaries/ec-202211-mortgage-borrowers-use-of-covid19-forbearance-programs.aspx#:~:text=In%20general%2C%20servicers%20provide%20borrowers,to%2012%20months%20of%20forbearance.>

Mallach, Alan. 2011. *Building Sustainable Ownership: Rethinking Public Policy Toward Lower-Income Homeownership*. Discussion paper. Federal Reserve Bank of Philadelphia. [https://silo.tips/download/building-sustainable-ownership-rethinking-public-policy-toward-lower-income-home.](https://silo.tips/download/building-sustainable-ownership-rethinking-public-policy-toward-lower-income-home)

McCann, Fergal, and Terry O'Malley. 2021. *Resolving Mortgage Distress After COVID-19: Some Lessons from the Last Crisis*. Working paper 121. Frankfurt, Germany: European Systemic Risk Board. [https://www.esrb.europa.eu/pub/pdf/wp/esrb.wp121~5615b74291.en.pdf?f15190b53fd322639ac0e9c60a1287f2.](https://www.esrb.europa.eu/pub/pdf/wp/esrb.wp121~5615b74291.en.pdf?f15190b53fd322639ac0e9c60a1287f2)

McCarthy, Yvonne. 2014. "Disentangling the Mortgage Arrears Crisis: The Role of the Labour Market, Income Volatility and Negative Equity," *Journal of the Statistical and Social Inquiry Society of Ireland* 43 (1): 71–90.

Moulton, Stephanie, Michael J. Collins, Căzilia Loibl, and Anya Samek. 2015. "Effects of Monitoring on Mortgage Delinquency: Evidence from a Randomized Field Study," *Journal of Policy Analysis and Management* 34 (1): 184–207.

Ngene, Geoffrey M., M. Kabir Hassan, William J. Hippler III, and Ivan Julio. 2016. "Determinants of Mortgage Default Rates: Pre-Crisis and Crisis Period Dynamics and Stability," *Journal of Housing Research* 25 (1): 39–64.

Nordvik, Viggo, and Jardar Sørvoll. 2014. "Interpreting Housing Allowance: The Norwegian Case," *Housing, Theory, and Society* 31 (3): 353–369.

Norris, Michael, Dermot Coates, and Fiona Kane. 2007. "Breaching the Limits of Owner Occupation? Supporting Low-Income Buyers in the Inflated Irish Housing Market," *International Journal of Housing Policy* 7 (3): 337–355.

Norwegian State Housing Bank (NSHB). 2021. *Årsrapport 2021*. Vedlegg 2 Analyse av Startlån. (Annual Report 2021. Appendix 2 Analysis of the Starter Mortgage). Norway: Norway State Housing Bank. <https://www.husbanken.no/om-husbanken/aarsrapporter/>

———. 2019. *Årsrapport 2019*. Vedlegg 2 Analyse av Startlån. (*Annual Report 2019*. Appendix 2 Analysis of the Starter Mortgage). <https://www.regjeringen.no/contentassets/6ed06d0c878446889f5d59c96feb3fe6/husbankens-arsrapport-for-2019.pdf>.

———. 2016. *Årsrapport 2016*. (*Annual Report 2016*). Norway: Norway State Housing Bank. <https://www.husbanken.no/om-husbanken/aarsrapporter/>.

———. 2014. *Årsrapport 2014*. Vedlegg IV Analyse av Startlån (*Annual Report 2014*. Appendix IV Analysis of the Starter Mortgage). https://www.regjeringen.no/globalassets/departementene/hod/tildeling-oppdrag-og-arsrapporter/2014/husbanken_aarsrapport_2014.pdf.

Perlmeier, Emily Ryder. 2022. "Pandemic Mortgage Relief Headed Off Delinquencies, but What Happens Now?" *Communities* blog, February 25. Federal Reserve Bank of Dallas. <https://www.dallasfed.org/cd/communities/2022/0225>.

Poggio, Teresio. 2006. "Different Patterns of Ownership in Europe," Homeownership in Europe: Policy and Research Issues Conference. Delft, the Netherlands.

Priemus, Hugo, and Frans Dieleman. 2002. "Social Housing Policy in the European Union: Past, Present and Perspectives," *Urban Studies* 39 (2): 191–200.

Quercia, Roberto G., Allison Freeman, and Janneke Ratcliffe. 2011. *Regaining the Dream: How to Renew the Promise of Homeownership for America's Working Families*. Washington, DC: Brookings Institution Press.

Quercia, Robert G., and Michael A. Stegman. 1992. "Residential Mortgage Default: A Review of the Literature," *Journal of Housing Research* 3 (2): 341–379.

Reid, Carolina K., Carly Urban, C., and J. Michael Collins. 2017. "Rolling the Dice on Foreclosure Prevention: Differences Across Mortgage Servicers on Loan Modifications and Loan Cure Rates," *Housing Policy Debate* 27 (1): 1–27.

Retsinas, Nicolas, and Eric Belsky. 2002. *Low-Income Homeownership: Examining the Unexamined Goal*. Washington, DC: Brookings Institution Press and Harvard University Joint Center for Housing Studies.

Rohe, William M., and Mark Lindblad. 2014. *Reexamining the Social Benefits of Homeownership After the Housing Crisis*. Cambridge: Harvard University, Joint Center for Housing Studies.

Rohe, William M., and Harry L. Watson. 2007. *Chasing the American Dream: New Perspectives on Affordable Homeownership*. Ithaca: Cornell University Press.

Rolnik, Raquel. 2013. "Late Neoliberalism: The Financialization of Homeownership and Housing Rights," *International Journal of Urban and Regional Research* 37 (3): 1058–1066.

Ronald, Richard. 2008. *The Ideology of Home Ownership: Homeowner Societies and the Role of Housing*. Basingstoke, England: Palgrave Macmillan.

- Sandlie, Hans C., and Jardar Sørvoll. 2017. "Et Velfungerende Leiemarked? (A Well Functioning Rental Market?)" *Tidsskrift for velferdsforskning* 20 (1): 45–59. <http://doi.org/10.18261>.
- Santiago, Anna Maria, and Joffré Leroux. 2022. "Does Pre-Purchase Counseling Help Low-Income Buyers Choose and Sustain Homeownership in Socially Mixed Destination Neighborhoods?" *Journal of Urban Affairs* 44 (3): 416–438. doi: 10.1080/07352166.2021.1944170.
- Seiler, Michael J. 2014. "The Effect of Perceived Lender Characteristics and Market Conditions on Strategic Mortgage Defaults," *Journal of Real Estate Finance Economics* 48 (2): 256–270.
- Skevik, Anne. 2003. "Children of the Welfare State: Individuals with Entitlements, or Hidden in the Family?" *Journal of Social Policy* 32 (3): 423–444. doi: <https://doi.org/10.1017/S0047279403007013>.
- Sørvoll, Jardar. 2011. *Norsk Boligpolitikk i Forandring 1970–2010. Dokumentasjon og Debatt (Norwegian Housing Policy and Change: Documentation and Debate)*. Oslo, Norway: Norwegian Social Research, Norsk Institutt for Forskning om Oppvekst, Velferd og Aldring.
- . 2009. *The Political Economy of Housing and the Welfare State in Scandinavia 1980-2008: Change, Continuity, and Paradoxes*. Oslo, Norway: Reassess-Nordic Center of Excellence in Welfare Research and Norwegian Social Research.
- Stamsø, Mary Ann. 2009. "Housing and the Welfare State in Norway," *Scandinavian Political Studies* 32 (2): 195–220.
- . 2008. "Grants for First-Time Homeowners in Norway: Distributional Effects Under Different Market and Political Conditions," *International Journal of Housing Policy* 8 (4): 379–397.
- Stanga, Irina, Razvan Vlahu, and Jakob de Haan. 2018. "Mortgage Delinquency Rates: A Cross-Country Perspective." <https://voxeu.org/article/mortgage-delinquency-rates-cross-country-perspective>.
- Tajaddini, Reza, and Hassan F. Gholipour. 2017. "National Culture and Default on Mortgages," *International Review of Finance* 17 (1): 107–133.
- Torgersen, Ulf. 1987. "Housing: the Wobbly Pillar under the Welfare State," *Scandinavian Housing and Planning Research* 4 (1): 116–126. doi: 10.1080/02815737.1987.10801428.
- Toussaint, Janneke, Gudrun Tegeder, Marja Elsinga, and Ilse Helbrecht. 2007. "Security and Insecurity of Home Ownership: Germany and the Netherlands," *International Journal of Housing Policy* 7 (2): 173–192.
- U.S. Government Accountability Office (GAO). 2021. *COVID-19 Housing Protections: Mortgage Forbearance and Other Federal Efforts Have Reduced Default and Foreclosure Risks*. Washington, DC: Government Printing Office. <https://www.gao.gov/products/gao-21-554>.
- Van Zandt, Shannon, and William M. Rohe. 2006. "Do First-Time Home Buyers Improve their Neighborhood Quality?" *Journal of Urban Affairs* 28 (5): 491–510.

Wainer, Allison, and Jeffrey Zabel. 2019. "Homeownership and Wealth Accumulation for Low-Income Households," *Journal of Housing Economics* 20: 1051–1377. <https://doi.org/10.1016/j.jhe.2019.03.002>.

Yates, Judith. 2003. "The More Things Change?" An Overview of Australia's Recent Home Ownership Policies," *International Journal of Housing Policy* 3 (1): 1–33.

Graphic Detail

Geographic Information Systems (GIS) organize and clarify the patterns of human activities on the Earth's surface and their interaction with each other. GIS data, in the form of maps, can quickly and powerfully convey relationships to policymakers and the public. This department of Cityscape includes maps that convey important housing or community development policy issues or solutions. If you have made such a map and are willing to share it in a future issue of Cityscape, please contact alexander.m.din@hud.gov.

Neighborhood Incarceration Rate Hot Spots in Maryland

Alexander Din

U.S. Department of Housing and Urban Development

The views expressed in this article are those of the author and do not represent the official positions or policies of the Office of Policy Development and Research, the U.S. Department of Housing and Urban Development, or the U.S. Government.

Abstract

Maryland's 2010 No Representation Without Population Act requires that census data used for political redistricting be adjusted so that Marylanders incarcerated in state and federal prisons will be enumerated at their last known address rather than their place of incarceration. This report briefly describes why this population adjustment process is important and then uses spatial analysis to identify neighborhood incarceration rate clusters, also referred to as hot spots or cold spots, and outliers. The results are mapped to visualize Maryland's areas of incarceration hot spot and cold spot clusters and outlier areas.

Why the No Representation Without Population Act Matters, and the Resultant Data

What neighborhoods do prisoners come from? In Maryland, that information is public knowledge because the state's 2010 No Representation Without Population Act requires census data used for redistricting purposes to be adjusted so that Marylanders incarcerated in federal and state

correctional facilities will be counted at their last known address rather than their place of incarceration.¹ Maryland was the first state in the United States to enact such a law (Wood, 2014). The U.S. Census Bureau (hereafter, Census Bureau) counts people at their “usual residence” when performing the decennial census enumeration; however, this approach is not always the best way to determine where a person is located. The Census Bureau estimates that approximately 3 percent of Americans do not live in a housing unit but instead live in group quarters, which are defined as “places where people live or stay in a group living arrangement that is owned or managed by an organization providing housing and/or services for the residents” (Stempowski, 2021). Group-quarters facilities are places such as college residence halls, residential treatment centers, skilled nursing facilities, group homes, military barracks, prisons, and worker dormitories.

Counting people at group-quarters locations can be problematic, particularly if they live at correctional facilities, because these citizens become “ghost constituents” (Wood, 2014). Prison gerrymandering is the process by which prisoners are counted at their places of incarceration, which are frequently located in rural communities or areas with predominately White populations (Ebenstein, 2018). Those White populations contrast with the prisoners themselves, who are typically ineligible to vote, are disproportionately of racial and ethnic minorities, and whose origin neighborhoods are depleted of population. The result is often the overrepresentation of rural areas in the political structure, which often have higher shares of White residents when delineating political representation (Stachulski, 2019). The incarceration rate used in this analysis is defined as the share of the population added to a census tract due to the No Representation Without Population Act.

Incarceration Rate by Neighborhood in Maryland

A report from the Prison Policy Initiative describes the high incarceration rate of some neighborhoods in Maryland (Prison Policy Initiative, 2022).² Baltimore City contains 9 percent of Maryland’s population, but 40 percent of prisoners in the state originate from the city.³ Many census tracts on the Eastern Shore, a rural area of Maryland which is poorer and whiter than the central portions of the state, also have elevated levels of incarceration. Previous analysis by the Justice Policy Institute and Prison Policy Initiative concluded that neighborhoods in Maryland with higher rates of incarceration are more likely to have higher unemployment rates, lower educational attainment, decreased life expectancy, greater vacant property rates, and poorer health indicators (Prison Policy Initiative and Justice Policy Institute, 2015).

Exhibit 1 maps the rate of incarceration by census tract in Maryland. Most census tracts (1,258 tracts, or 85.3 percent of the state total) have an incarceration rate of less than 500 per 10,000 population, slightly below the national rate of 0.629 percent (World Prison Brief, 2021). Baltimore City has a clear concentration of neighborhoods with high incarceration rates. The “White L” and “Black Butterfly,” as defined by Lawrence Brown of Morgan State University, appear on maps as

¹ Maryland Sn. 400; Hr. 496. 2010. “No Population Without Representation.” <https://mgaleg.maryland.gov/mgaweb/site/search/legislation?target=/2010rs/billfile/hb0496.htm>.

² Maryland Sn. 400; Hr. 496. 2010. “No Population Without Representation.” <https://mgaleg.maryland.gov/mgaweb/site/search/legislation?target=/2010rs/billfile/hb0496.htm>.

³ Baltimore City is an independent city not associated with any county and functions as county-level equivalent in Maryland.

the distinctive geographies in Baltimore that outline race and inequality in the city and nearby suburbs (Brown, 2022). Many census tracts in the southern Eastern Shore area also have high rates of incarceration. Pockets of census tracts with higher rates of incarceration are also present throughout the state, particularly in Prince George’s County along the border with Southeast Washington, D.C., an area with a high density of violent crime, including homicides (Sweet, Alexander, and Alexander, 2020).

Exhibit 1

Incarceration Rate by Census Tract in Maryland, 2020

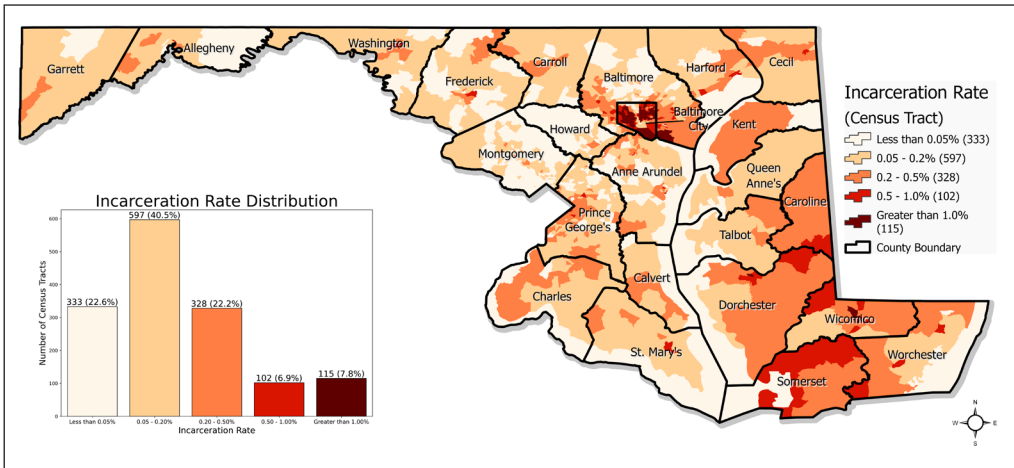

Source: Data from 2020 Redistricting Data for Maryland (<https://redistricting.maryland.gov/Pages/data.aspx>) and analysis by author

Detecting Neighborhood Incarceration Rate Hot Spots

The data used for this analysis were the number of people incarcerated per population of 10,000. This value ranges from 0 (139 census tracts, or 9.4 percent of neighborhoods) to 3,767, or nearly 4 percent of the population being incarcerated.⁴ That rate is nearly six times higher than the rate for the United States (0.629%), which is the highest rate of incarceration in the world (World Prison Brief, 2021).

This hot spot analysis uses the Cluster and Outlier function in ArcGIS Pro, Esri’s implementation of the Anselin Local Moran’s Index (Anselin, 1995). This core concept of the tool is built on Tobler’s First Law of Geography that “everything is related to everything else, but near things are more related than distant things” (Tobler, 1970). The function has two purposes. First, it produces a Global Moran’s Index, which describes whether a set of values are spatially dispersed, random, or clustered. Second, the function identifies local areas of clustering and outliers. Clustering can be areas of high values surrounded by similarly high values (referred to as High-High) or areas of low values surrounded by similarly low values (Low-Low). Outliers are areas of either high values surrounded by low values (High-Low) or areas of low values surrounded by high values (Low-High). The formula for the function is as follows (Esri, 2022):

⁴ One census tract in southern Baltimore City had an incarceration rate of 8 percent; however, it had only a population of 25 after the adjustment.

$$I_i = \frac{x_i - \bar{X}}{S_i^2} \sum_{j=1, j \neq i}^n w_{i,j} (w_j - \bar{X})$$

where:

- x_i is an attribute for feature i
- \bar{X} is the mean of the corresponding attribute
- $w_{i,j}$ is the spatial weight between feature i and j

$$S_i^2 = \frac{\sum_{j=1, j \neq i}^n (x_j - \bar{X})^2}{n - 1}$$

with n equating to the number of the feature.

The Cluster and Outlier Analysis function outputs a report describing spatial autocorrelation of a set of values across space or the degree to which the values are clustered, dispersed, or random (Getis, 2010). The Global Moran's Index value was 0.41, indicating a moderately strong degree of clustering.⁵ The census tract-level results that were locally statistically significant are mapped in exhibit 2.

Exhibit 2

Incarceration Hot Spots in Maryland, 2020

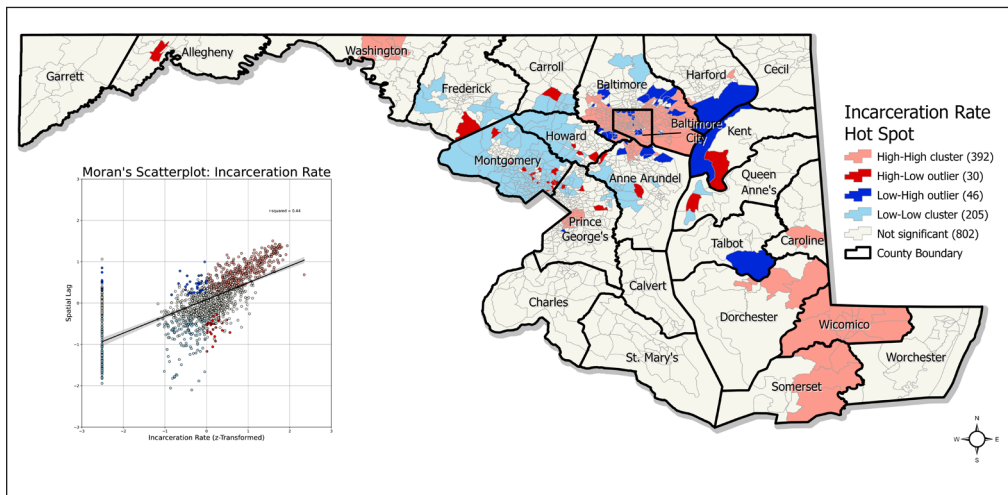

Source: Data from 2020 Redistricting Data for Maryland (<https://redistricting.maryland.gov/Pages/data.aspx>) and analysis by author

Hot Spots, areas categorized as High-High, primarily appear in four areas throughout Maryland. The largest High-High cluster is in and around Baltimore City and its eastern and western suburbs. The “White L” and “Black Butterfly” mostly remain visible in this analysis. Several census tracts in western Maryland near Hagerstown, the Eastern Shore, and a portion of Prince George’s County are

⁵ $p < 0.0001$.

also High-High Clusters. Low-Low census tracts tend to cluster in the center of the state, mostly throughout the wealthier suburban counties, such as Frederick, Montgomery, Howard, southern Carroll, northern Prince George's, and western Anne Arundel counties. A few Low-Low census tracts are in Baltimore and Queen Anne's counties.

High-Low outliers, census tracts which have a higher rate of incarceration but are proximate to census tracts with low rates of incarceration, are primarily scattered throughout central Maryland, except for one census tract in Washington County. The High-Low census tract in northern Montgomery County is a signal for potential error in redistricting adjustment because the census tract contains a county detention facility and is in a generally wealthier area surrounded by Low-Low census tracts. Low-High census tracts, neighborhoods with low incarceration rates near census tracts with high incarceration rates, are primarily adjacent to High-High census tracts in and around Baltimore City, except for one census tract in Talbot County. These census tracts have lower incarceration rates, but they are near extremely high incarceration areas in Baltimore City.

Acknowledgments

The author thanks Brian Stromberg for his helpful comments.

Author

Alexander Din is a social science analyst in the Office of Policy Development & Research at the U.S. Department of Housing and Urban Development.

References

- Anselin, Luc. 1995. "Local Indicators of Spatial Association—LISA," *Geographical Analysis* 27 (2): 93–115.
- Brown, Lawrence. 2022. "The Black Butterfly: The Harmful Politics of Race and Space in America," Baltimore, Maryland. Johns Hopkins University Press.
- Ebenstein, Julia, 2018. "The Geography of Mass Incarceration: Prison Gerrymandering and the Dilution of Prisoners Political Representation," *Fordham Urban Law Journal* 45 (2): 323–372.
- Esri. 2022. "How Cluster and Outlier Analysis (Anselin Local Moran's I) Works." <https://pro.arcgis.com/en/pro-app/latest/tool-reference/spatial-statistics/h-how-cluster-and-outlier-analysis-anselin-local-m.htm>.
- Getis, Arthur. 2010. "Spatial Autocorrelation." In *Handbook of Applied Spatial Analysis: Software Tools, Methods and Applications*, edited by Manfred M. Fisher. Berlin, Germany: Springer.

Justice Policy Institute and Prison Policy Initiative. 2015. "The Right Investment?" Corrections Spending in Baltimore City." <https://www.prisonpolicy.org/origin/md/report.html>.

Prison Policy Initiative. 2022. "New Data Reveals Where People in Maryland Prisons Come From." <https://www.prisonpolicy.org/blog/2022/06/27/mdorigin/>.

Stachulski, Faith. 2019. "Prison Gerrymandering: Locking up Elections and Diluting Representational Equality," *University of Illinois Law Review* 1: 401–428. <https://www.illinoislawreview.org/wp-content/uploads/2019/03/Stachulski.pdf>.

Stempowski, Deborah. 2021. "2020 Census Group Quarters." <https://www.census.gov/newsroom/blogs/random-samplings/2021/03/2020-census-group-quarters.html>.

Sweet, Sarah, Gabriel Alexander, and Russell Alexander. 2020. "The Death of Freddie Gray and Its Impact on Homicides in Baltimore and Maryland," *Journal of Forensic Sciences* 65 (5): 1539–1547. doi: 10.1111/1556-4029.14499.

Tobler, W. R. 1970. "A Computer Movie Simulating Urban Growth in the Detroit Region," *Economic Geography* 46: 234–240.

Wood, Erika L. 2014. *Implementing Reform: How Maryland & New York Ended Prison Gerrymandering*. https://digitalcommons.nyls.edu/cgi/viewcontent.cgi?referer=&httpsredir=1&article=1002&context=fac_other_pubs.

World Prison Brief, Institute for Crime & Justice Policy Research. 2021. "Highest to Lowest - Prison Population Total" <https://www.prisonstudies.org/highest-to-lowest/prison-population-total>.

Visualizing Spanish Speaking Limited English Proficiency and Hispanic Populations in Fort Collins, Colorado

Brent D. Mast

U.S. Department of Housing and Urban Development

Tricia Ruiz

U.S. Department of Housing and Urban Development

The views expressed in this article are those of the author and do not represent the official positions or policies of the Office of Policy Development and Research, the U.S. Department of Housing and Urban Development, or the U.S. Government.

Introduction

Between 2010 and 2019, the U.S. population grew by 18.9 percent, and the increase in the number of Hispanics or Latinos contributed to 52 percent of this increase (Krogstad, 2020). In 2020, there were 59,361,020 Hispanics or Latinos in the United States, comprising approximately 18 percent of the total population.¹

Since 2000, English proficiency has increased among the Hispanic and Latino population (Funk and Lopez, 2022). The Pew Research Center reported that the percentage of Hispanics speaking Spanish declined from 78 percent in 2000 to 73 percent in 2013 (Krogstad, Stepler, and Lopez, 2015). The Pew report also indicated that there has been an increase in U.S.-born Latinos who speak English proficiently, from 72 percent in 1980 to 89 percent in 2013, and that part of this trend was due to more U.S.-born Hispanics living in households where only English is spoken.

The U.S. Census Bureau collects information on languages spoken at home for the population ages 5 years and older, and the population with limited English proficiency (LEP) reported speaking English less than “very well.” Besides English, Spanish is the largest language group in the United States. In 2020, there were 40,537,337 people in the United States who reported speaking Spanish, of which 24,587,755, or 61 percent, spoke English “very well,” and 15,949,582, or 39 percent, reported speaking English less than “very well.”² We refer to this latter group as the Spanish LEP population.

¹ Authors' tabulations of Census 2020 Table P2: Hispanic or Latino, and Not Hispanic or Latino by Race.

² Authors' tabulations of Census American Community Survey 2016-2020 Table C16001: Language Spoken at Home for the Population 5 Years and Over.

Understanding the geographical aspects of these trends can be useful for policymakers and communities in overcoming barriers related to language access and for researchers interested in local demographic change. In this report, the spatial concentration or segregation of Hispanics or Latinos is compared with the Spanish LEP population. To the authors' knowledge, this is the first study to analyze the relationship between a Spanish LEP population and a Hispanic population. This report uses a commonly used segregation measure, the Dissimilarity Index (DI), and employ data visualizations to compare both groups. Data are analyzed for neighborhood patterns in 47 census tracts intersecting the city of Fort Collins, Colorado, as a case study.

Data Description

Data for Fort Collins are summarized in exhibit 1 below.

Exhibit 1

Descriptive Statistics					
Variable	Mean	StdDev	Min	Median	Max
Non-LEP population	3,839.745	1,911.727	1,216	3,340	10,753
Spanish speaking LEP population	66.255	102.005	0	32	557
% Spanish speaking LEP population	1.812	3.326	0	0.943	20.830
White non-Hispanic population	3,353.745	1,769.925	882	2,918	9,946
Hispanic population	525.128	368.338	41	435	1,760
% Hispanic population	13.021	10.058	1.440	11.554	65.819

N = 47. StdDev = standard deviation.

Source: Authors' tabulations of Census American Community Survey (ACS) 5-year 2018 Table B03002 and Table C16001

To measure the concentration of LEP populations vs. non-LEP populations and White/non-Hispanic populations vs. Hispanic populations, DIs are calculated to determine the level of concentration (or clustering) in both cases. For simplification, these pairings are referred to as Spanish LEP concentration and Hispanic concentration, respectively, from this point forward.

The DI formula is in the equation below.

$$DI = .5 * \sum_{i=1}^N abs[\frac{a_i}{A} - \frac{b_i}{B}]$$

In the equation, *i* represents census tract *i*; *N* represents the total number of census tracts in the area for which the DI is being computed; *abs* represents absolute value; *a_i* represents the population of group A in census tract *i*; *A* represents the total group A population in the area for which the DI is being computed; *b_i* represents the group B population in census tract *i*; and *B* represents the total group B population in the area for which the DI is being computed.

The range of values for the DI is zero to one. A DI of zero indicates no concentration, and a DI of one indicates maximum concentration. For the city of Fort Collins, the Spanish LEP DI equals 0.467, and the Hispanic DI equals 0.224. Thus, the Spanish LEP concentration is estimated to be roughly twice that of the Hispanic concentration. The next section provides a data visualization

of these spatial patterns and differences between Hispanic concentration and the Spanish LEP concentration.

Data Visualizations

In this section, patterns of Spanish LEP concentration and Hispanic concentration are visualized with a conditioned choropleth map and scatterplots. A conditioned choropleth map charts a continuous variable (in this case, Spanish LEP) conditioned on multiple categories of a discrete variable (percent Hispanic in this analysis). Exhibit 2 provides a table indicating the four categories or levels of percent Hispanic or Latino. Each category has 12 tracts, and Categories 2 and 3 overlap due to the odd number of tracts. These four categories are labeled as Low, Low-Moderate, High-Moderate, and High. For example, the 12 tracts in the High Category have Hispanic population shares ranging from 14.43 percent to 65.82 percent.

Exhibit 2

Categories of Percent Hispanic

Category	Tracts	Min	Max
1 Low	12	1.438	8.022
2 Low-Moderate	12	8.513	11.552
3 High-Moderate	12	11.552	14.224
4 High	12	14.432	65.821

N = 47.

Source: Authors' tabulations of Census American Community Survey (ACS) 5-year 2018 Table B03002

Exhibit 3 displays the percent of the population that are Spanish speaking LEP, conditioned on four categories of percent that are Hispanic reported in exhibit 2. This exhibit illustrates how the Spanish LEP population, expressed as a continuous variable, intersects with the four levels of the percent that are Hispanic.

Exhibit 3

Percent Spanish Speaking LEP Conditioned on Percent Hispanic

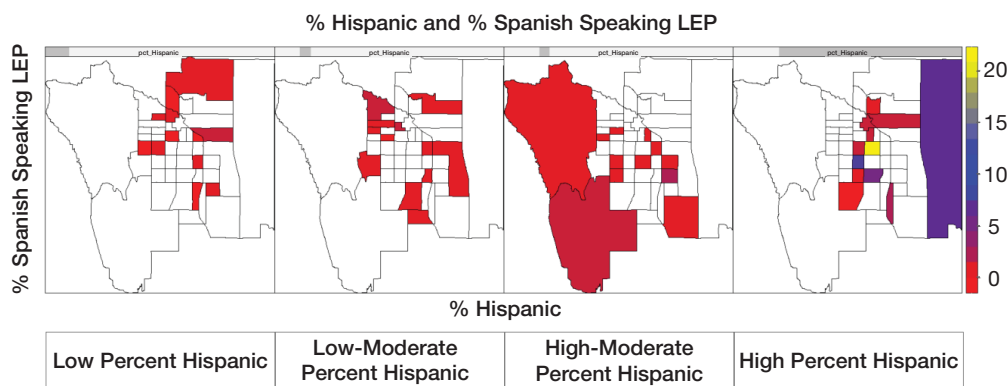

N = 47.

Source: Authors' tabulations of Census American Community Survey (ACS) 5-year 2018 Table B03002 and Table C16001

The maps in the first three columns of exhibit 3 show that levels of the percent who are Hispanic are similar to the levels of the percent who are Spanish LEP. Most tracts with a low percentage of Hispanics also have low percentages of those who are Spanish LEP. Most tracts with low to moderate percent Hispanic populations also have low to moderate percentages of Spanish LEP populations, and tracts with medium to high percentages of Hispanic populations generally also have medium to high percentages of Spanish LEP populations. However, the map in the fourth column of exhibit 3 has a few notable outliers, demonstrating that tracts with high percentages of Hispanic populations have a fairly wide range of percentages that are Spanish LEP. Some tracts had low percentages of Spanish LEP populations, despite having higher percentages of Hispanics. These data may suggest that there are areas where there are more Hispanics proficient in English than Hispanics who are Spanish LEP.

To accompany the maps, a Pearson correlation coefficient was computed between the percent of Hispanics and the percent who are Spanish LEP across the tracts, which was 0.918. However, this correlation is driven by three tracts with the percent of Hispanics greater than 25 percent, as demonstrated in the scatterplot in exhibit 4. The scatterplot in exhibit 5 has the three tracts with percentage of Hispanics greater than 25 percent removed; the Pearson correlation coefficient for the data in this plot is 0.480.

Exhibit 4

Scatterplot 1

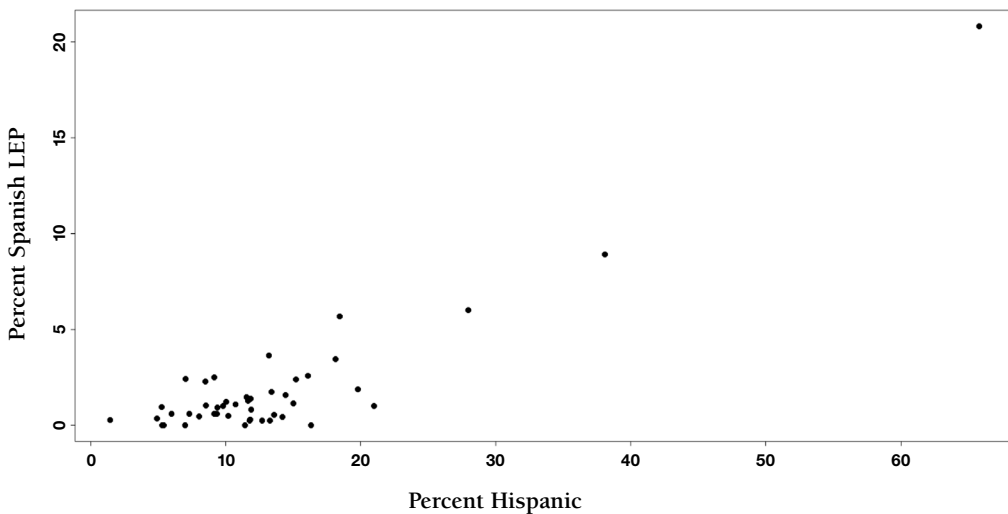

N = 47.

Source: Authors' tabulations of Census American Community Survey (ACS) 5-year 2018 Table B03002 and Table C16001

Exhibit 5

Scatterplot 2

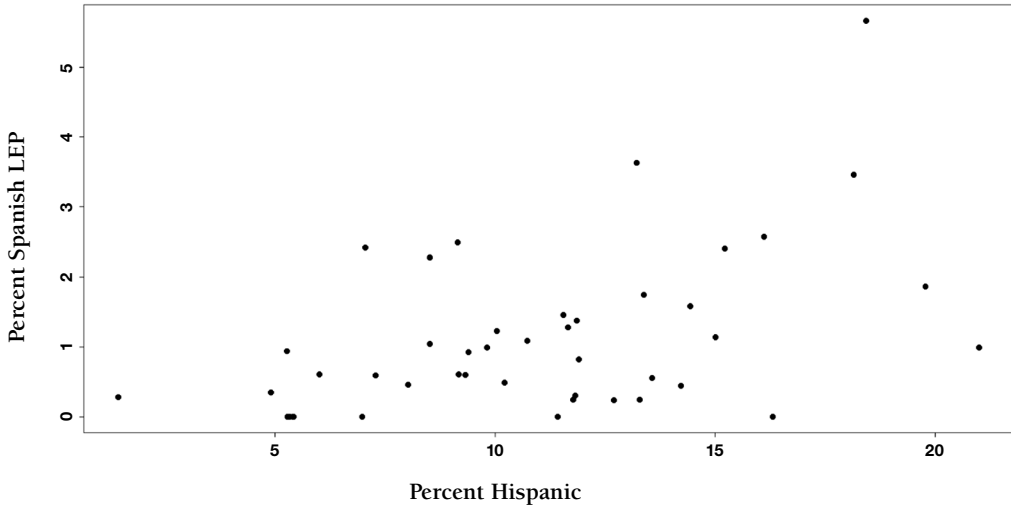

N = 44.

Source: Authors' tabulations of Census American Community Survey (ACS) 5-year 2018 Table B03002 and Table C16001

Conclusion

In this report, the relationship between the Spanish LEP population and Hispanic population is explored in Fort Collins, Colorado. As measured by the DI, the Spanish LEP concentration is about twice the concentration of the Hispanic population.

The data are visualized with a conditioned choropleth map and scatterplots. The conditioned choropleth map indicates that tracts with low, low to moderate, and moderate to high percentages of Hispanics also tend to have similar percentages of those who are Spanish LEP. However, tracts with high Hispanic population percentages have wide ranging percentages of Spanish LEP populations.

When the percent who are Hispanic is compared with the percent who are Spanish LEP across tracts, the correlation between them is calculated to be very high, which at first seems contrary to what one might expect, given that the city-wide concentration of the two groups was not equivalent, as measured by the DI. However, the correlation of the tract level data is driven by only three tracts with high percentages of Hispanics. When these three tracts are eliminated from the data analysis, the correlation is quite moderate.

Authors

Brent D. Mast is a social science analyst at HUD's office of Policy Development and Research. Tricia Ruiz is a geographer at HUD's office of Fair Housing and Equal Opportunity.

References

Funk, Cary, and Hugo Lopez. 2022. "A Brief Statistical Portrait of U.S. Hispanics." Pew Research Center. <https://www.pewresearch.org/science/2022/06/14/a-brief-statistical-portrait-of-u-s-hispanics/>.

Krogstad, Jens Manuel. 2020. "Hispanics Have Accounted for More Than Half of Total U.S. Population Growth Since 2010." Pew Research Center. <https://www.pewresearch.org/fact-tank/2020/07/10/hispanics-have-accounted-for-more-than-half-of-total-u-s-population-growth-since-2010/>.

Krogstad, Jens Manuel, Renee Stepler, and Mark Hugo Lopez. 2015. "English Proficiency on the Rise Among Latinos." Pew Research Center. <https://www.pewresearch.org/hispanic/2015/05/12/english-proficiency-on-the-rise-among-latinos/#fn-22303-1>.

Impact

A regulatory impact analysis must accompany every economically significant federal rule or regulation. The Office of Policy Development and Research performs this analysis for all U.S. Department of Housing and Urban Development rules. An impact analysis is a forecast of the annual benefits and costs accruing to all parties, including the taxpayers, from a given regulation. Modeling these benefits and costs involves use of past research findings, application of economic principles, empirical investigation, and professional judgment.

Regulatory Impact Analysis of Manufactured Home Construction and Safety Standards

Michael Hollar

U.S. Department of Housing and Urban Development

The views expressed in this article are those of the author and do not represent the official positions or policies of the Office of Policy Development and Research, the U.S. Department of Housing and Urban Development, or the U.S. Government.

Background

In 1974, the U.S. Congress passed the National Manufactured Housing Construction and Safety Standards Act (42 U.S.C. 5401 et seq.), which authorized the U.S. Department of Housing and Urban Development (HUD) to establish and enforce construction and safety standards for factory-built manufactured housing. Congress created a single, preemptive code to both ease the burden on manufacturers and establish consumer protections. Establishment of a uniform code applicable to all states would decrease production costs while ensuring a minimum level of safety. In addition, federal superintendence of manufactured homebuilding standards reduced the burden on states that lacked resources to adequately enforce construction and safety standards for manufactured homes.

The Manufactured Housing Improvement Act of 2000 amended the original statute primarily to facilitate timely updates to the national manufactured construction and safety standards. Recognizing HUD's inability to update the standards on a timely basis, which created challenges for technological innovation within the manufactured housing industry, the Manufactured Housing Improvement Act established the Manufactured Housing Consensus Committee (MHCC).¹ The

¹ <https://www.congress.gov/congressional-report/106th-congress/senate-report/274>.

MHCC is a federal advisory committee composed of 21 voting members equally representing three primary interest groups. The interest groups are manufactured housing producers and retailers, consumers and consumer organizations, and general interest and public officials with an interest in manufactured housing. The MHCC meets regularly to consider and recommend changes in the construction and safety code. Since its inception, the MHCC has recommended five sets of updates to the manufactured housing construction and safety standards. The first three sets of updates were promulgated in 2005 (70 FR 72023), 2013 (78 FR 73965), and 2021 (86 FR 2496). On July 19, 2022, HUD published a proposed rule (FR-6233) that represents the fourth and fifth sets of MHCC-recommended updates.

Changes to HUD's Manufactured Housing Code

HUD's Manufactured Housing Code consists of six parts.

- (1) Part 3280—Manufactured Home Construction and Safety Standards.
- (2) Part 3282—Manufactured Home Procedural and Enforcement Regulations.
- (3) Part 3284—Manufactured Housing Program Fee.
- (4) Part 3285—Model Manufactured Home Installation Standards.
- (5) Part 3286—Manufactured Home Installation Program.
- (6) Part 3288—Manufactured Home Dispute Resolution Program.

This proposed rule amends Parts 3280, 3282, 3285, and 3286. The changes include recommendations from the Manufactured Housing Consensus Committee, which recommended 31 direct changes, primarily to the construction and safety standards, but also the model installation standards and installation program, and 8 changes to update or add reference standards in the “Incorporation by Reference,” or IBR, provisions, which are in 24 CFR § 3280.4.² Many of the proposed changes would codify existing building practices or conform HUD standards to other existing residential building codes. The sole change to 24 CFR Part 3282 is related to the codification of multi-unit homes.

Of the 39 proposed updates, 22 updates do not have a measurable cost impact. These provisions generally align with or streamline current practice or provide flexibility and increase options for manufacturers, installers, and consumers. Thirteen provisions are expected to have measurable or notable costs or benefits by directly affecting production or installation. Finally, four updates will reduce costs by eliminating the need for manufacturers to apply for an exemption to the current standards through the Alternative Construction process. These proposed updates are already in effect for a limited number of homes, as indicated below. Codifying these changes relieves manufacturers from the administrative burden of applying for an Alternative Construction letter and complying with its requirements.

Proposed Code Revisions that Affect Costs or Benefits, or Both

The effect of each proposed code change was evaluated using two reference homes. The smaller home is a one-bedroom, one-bathroom, 493-square-foot (37 feet long and 13 feet 4 inches

² The eight IBR changes include 88 updated or added reference standards.

wide) single-section dwelling. The larger home is a two-bedroom, one and a half-bathroom, 2,000-square-foot (68 feet by 30 feet 4 inches) double-section structure. Consistent with recent production and shipment sizes reported in the U.S. Census Bureau's 2021 Census of Manufactured Housing, the cost estimates assume that 48 percent of shipments are the small reference home, and 52 percent are the large reference home. Given the relative steadiness of production and shipments in recent years, this analysis assumes annual production of 105,400, which is the number of shipments during the 12 months from December 2020 through November 2021.

This analysis presents costs and benefits for a cohort that represents a single annual production year. The change in production and installation costs are one-time, upfront costs in the year of production or installation. The structural and safety-related benefits occur each year during the life of the home. Thus, the change in one-time, upfront costs is compared with the net present value of the stream of benefits during the life of the homes produced in a single production year.

Among the code changes and updates proposed in this notice, only the following 13 changes are expected to materially affect costs or benefits, or both. Exhibit 1 lists the expected costs and benefits resulting from these updated standards for a representative production year, as explained previously. The costs are one-time, upfront increases that occur only at the time of production or installation, but the benefits continue to accrue during the life of the home. Exhibit 2a lists the annual stream of safety-related benefits per production year. These benefits occur each year during the life of the home. Exhibit 2b provides the net present value of the stream of benefits during 30 and 45 years. Manufactured homes have an expected life of 30 to 55 years. Thus, the net present value of benefits calculated for 30 years should be considered a minimum.

Materials: § 3280.304(a)

This rule change allows builders to use lumber with a moisture content above 19 percent for exterior purposes (porches and decks). Higher moisture content in pressure-treated lumber used on the home exterior is not a safety or structural concern; however, allowing manufacturers to use lumber with a higher moisture content avoids the need to either purchase kiln-dried lumber or wait approximately 3 weeks for the lumber to dry naturally. Using lumber with a higher moisture content will decrease the cost of homes with inset porches by \$66 to \$201. HUD estimates that between 10 and 30 percent of manufactured homes have inset porches. In aggregate, this provision is expected to reduce upfront production costs by \$702,596 to \$6,355,620 per production year. In addition to the cost savings, this provision may also result in time and material storage savings, because manufacturers will not need to dry lumber or store the lumber and wait for it to dry.

Circulating Air Systems: § 3280.715(a)

This rule change permits supply air ducts that are within 3 feet of the furnace to be made of less fire-resistant material if those ducts are rated to withstand the maximum discharge air temperature of the equipment. This rule change will decrease upfront production costs by \$68 per home. HUD estimates that between 10 and 30 percent of manufactured homes will be affected. In aggregate, this provision is estimated to reduce costs between \$711,450 and \$2,134,350 per production year.

Exhibit 1

Change in One-Time, Upfront Production or Installation Costs per Production Year

Description	Small Home				Large Home				Estimated Aggregate Cost per Production Year	
	# Affected		Cost Estimate		# Affected		Cost Estimate		Low	High
	Low	High	Low	High	Low	High	Low	High		
1 Moisture content of treated lumber used for exterior purposes.	5,015	15,045	(\$67)	(\$201)	5,525	16,575	(\$67)	(\$201)	(\$702,596)	(\$6,355,620)
2 Air ducts temperature ratings.	5,015	15,045	(\$68)		5,525	16,575	(\$68)		(\$711,450)	(\$2,134,350)
3 Resistance to elements and use—water resistive barrier.	35,106	42,629	\$323	\$670	552	11,050	\$323	\$670	\$11,522,296	\$23,902,532
4 Kitchen cabinet fire protection.		50,151	(\$4.35)	\$9.79		55,249	(\$6.09)	\$18.27	(\$554,623)	\$1,500,375
5 Maximum distance of fixture trap to vent.						55,249	(\$261)		(\$14,419,913)	(\$14,419,913)
6 Under-chassis line-voltage wiring protection.	5,015	15,045	(\$195)		5,525	16,575	(\$195)		(\$2,055,300)	(\$6,165,900)
7 Reference to AWC National Design Specification for Wood Construction.	25,076	40,121	\$91		27,624	44,199	\$704		\$21,723,904	\$34,758,247
8 Structural design requirements for attics.	5,015	15,045	(\$104)	(\$151)	5,525	16,575	(\$617)	(\$766)	(\$3,930,419)	(\$4,989,336)
9 Water system piping testing procedures.	12,538	30,091	(\$1.46)		13,812	33,149	(\$1.46)		(\$38,471)	(\$92,330)
Total									\$10,833,428	\$26,003,706
<i>Weighted Average per Unit</i>			\$78.48	\$104.97			(\$2.20)	\$17.64	\$34.12	\$57.55

AWC = American Wood Council.

Source: HUD calculations

Exhibit 2a

Increase in Annual Benefits

Benefits	Small Home				Large Home				Total Annual Avoided Cost per Production Year	
	# Affected		Avoided Cost		# Affected		Avoided Cost		Low	High
	Low	High	Low	High	Low	High	Low	High		
Resistance to elements and use – water resistive barrier.	667	810	\$4,082		10	210	\$7,041		\$2,793,104	\$4,201,304
Kitchen cabinet fire protection.										
Fire Damage Avoided		50,151	\$3.61			55,249	\$3.28		\$181,176	
Deaths Avoided		50,151	\$92.52			55,249	\$83.98		\$4,640,000	
Total									\$7,614,280	\$9,022,480
<i>Weighted Average per Unit</i>			\$74.71	\$80.38			\$44.26	\$56.90	\$58.80	\$68.11

Source: HUD calculations

Exhibit 2b

Net Present Value of Increase in Annual Stream of Benefits per Production Year

Description	Net Present Value of Benefits over 30 Years				Net Present Value of Benefits over 45 Years			
	3% Discount Rate		7% Discount Rate		3% Discount Rate		7% Discount Rate	
	Low	High	Low	High	Low	High	Low	High
Resistance to elements and use – water resistive barrier.	\$77,789,818	\$117,009,132	\$70,520,477	\$106,074,805	\$115,362,538	\$180,028,692	\$103,014,713	\$169,094,365
Kitchen cabinet fire protection.								
Fire Damage Avoided	\$5,045,886		\$4,574,356		\$7,483,065		\$6,682,115	
Deaths Avoided	\$129,227,110		\$117,151,031		\$191,644,199		\$171,131,569	
Total	\$212,062,814	\$251,282,128	\$192,245,863	\$227,800,191	\$314,489,802	\$379,155,956	\$280,828,397	\$346,908,049

Source: HUD calculations

Installation of Appliances: § 3280.709(a)

This change removes the requirement that installers leave the appliance manufacturer's instructions attached to the appliance. The code is currently unclear on how appliance instructions are to be provided to the homeowner, resulting in hard copy duplication. Currently, instructions are supplied with each appliance and additionally with the homeowner's manual. This proposed change eliminates the unnecessary duplication of providing two sets of appliance instructions to the homeowner.

Resistance to Elements and Use: § 3280.307

This change requires that the exterior wall envelope include a water-resistive barrier behind the exterior cladding and a means of draining water that enters the assembly to avoid water damage to the home. Water-resistive barriers are common in higher-end manufactured homes; this change will primarily affect lower-end and smaller manufactured homes. HUD estimates that this change will affect 70 to 85 percent of small, manufactured homes and 10 to 20 percent of large, manufactured homes. The upfront cost of including a water-resistive barrier ranges from \$323 to \$670 per home. In aggregate, this change will increase upfront costs from \$11,522,296 to \$23,902,532 per production year.

This change provides ongoing benefits to the homeowner during the life of the home by adding a second layer of protection from bulk water damage. Although the amount of water damage specific to manufactured homes is not available, the Insurance Information Institute reports that between 2015 and 2019, an average of 1.9 percent of homeowners annually filed a homeowners insurance claim related to water damage or freezing. Applying this percentage to the affected homes yields between 677 and 1,020 manufactured homes annually that would avoid water damage due to this requirement (see exhibit 2a). The average claim severity for water damage and freezing from 2015 to 2019 was \$11,098. This figure represents 5.1 percent of the median value of the home based on the 2019 American Community Survey, which reports a median home value of \$217,500. According to the Census of Manufactured Housing Survey, the average sales price is \$80,000 for a single-section manufactured home and \$138,000 for a multisection home as of August 2021. Thus, the average expected avoided damage per home per year totals \$4,080 for small homes and \$7,041 for large homes. These savings occur as a stream of benefits for the life of the home. Discounting this stream of ongoing annual benefits per production year totals between \$77.8 and \$169.0 million.

Flame Spread Limitations and Fire Protection Requirements: § 3280.203 and § 3280.204

This change updates the flame spread rating requirements for various products used in manufactured home construction, and it contains requirements that are specific to kitchen cabinets. This update stipulates that nonhorizontal surfaces of cabinets above the bottom of the range hood do not have to be surfaced and protected with "limited combustible material." The rule also requires that, where range hood finish materials are installed, the finish material's flame spread rating shall not exceed 200, and gypsum board (or a material of equivalent limited combustibility) that is at minimum 5/16 inch thick must separate the finished material from the metal range hood.

This update will decrease upfront production costs related to not having to install "limited combustible material," saving \$4.35 per small home and \$6.09 per large home. Installing an under-

cabinet range hood instead of a wall-mounted range hood could offset these cost savings. In this scenario, total upfront costs would increase by \$9.79 per small home and \$18.27 per large home. In the aggregate, the change in upfront costs at the time of production is expected to range from a decrease of \$554,623 to an increase of \$1,500,375 per production year.

This code change will provide a stream of benefits to homeowners during the life of the home by increasing fire safety where range hood finishes are used. According to the National Fire Protection Association, cooking equipment causes 1,700 fires in manufactured homes annually (Hall, 2013). Direct property damage from these fires totals \$14 million annually (\$8,235 per fire), resulting in 31 deaths and 105 injuries. According to the 2019 American Housing Survey, 8.262 million manufactured homes were in the United States. Thus, new annual production represents 1.28 percent of the existing manufactured housing stock. Based on annual production of 105,400 units, fire is expected to damage 22 manufactured homes annually in each production year. Using the average of \$8,235 per fire, the aggregate annual value of fire damage that would be avoided by this code change is \$181,176 per production year. Similarly, based on 31 annual deaths from fire, or 0.0182 deaths per fire, 0.4 lives annually are expected to be saved from this rule change per production year. The value of a statistical life totals \$11.6 million, and avoiding 0.4 deaths totals \$4.64 million (DOT, 2021). Exhibit 3 shows the net present value of avoided fire damage and lives saved during 30 and 45 years for 3 and 7 percent discount rates. This value represents the stream of benefits per production year.

Exhibit 3

Upfront Cost Savings per Production Year from Provisions that Eliminate Need for Alternative Construction (AC) Letters

	Accessible Shower	Tankless Water Heater	Single Package Vertical Units	Doors & Windows	Total
Avg Annual AC Requests	14	7	13	2	
Approximate Units per Request	250	500	250	2,000	
Hours					
Prepare request	20	20	20	20	
Recordkeeping	2	2	2	2	
DAPIA Review	4	4	4	8	
IPIA Inspection (5 hrs per home)	1,250	2,500	1,250	10,000	
In-Plant QC (0.5 hrs per home)	125	250	125	1,000	
Total Hours	1,401	2,776	1,401	11,030	
Average Hourly Wage¹					
Civil Engineer	\$45.88	\$45.88	\$45.88	\$45.88	
CAD Operator	\$27.21	\$27.21	\$27.21	\$27.21	
Quality Auditor or Building Inspector	\$31.96	\$31.96	\$31.96	\$31.96	
Total Savings Per Production Year	\$22,585	\$106,480	\$62,535	\$370,333	\$561,933
Savings per home	\$90	\$213	\$250	\$185	

CAD = computer-aided design. DAPIA = Design Approval Primary Inspection Agency. IPIA = In-Plant Inspection Agency. QC = quality control.

¹ Bureau of Labor Statistics (BLS) mean hourly wage, Occupational Employment and Wages, May 2020.

Source: HUD calculations

Vents and Venting, Size of Vent Piping: § 3280.611(c)

This rule change increases the maximum distance of a fixture trap to the vent, which will align the HUD Code with the International Plumbing Code. Maximum distances increased by as little as 6 inches for a 1¼-inch diameter drainpipe and as much as 6 feet for a 3-inch diameter drainpipe. This change is expected to only affect homes with larger master bathrooms designed with two vents or homes with two adjacent bathrooms, which is less common. Smaller homes typically have one bathroom and one vent pipe. In homes with larger master bathrooms that require two vent pipes, this change will eliminate the need for a second vent, reducing the cost by \$261 per home. In aggregate, this update will reduce costs by \$14,419,913 per production year.

In addition to decreasing costs, this change also provides more flexibility in designing circuit vents. The increased maximum distances allow the designers to locate the vent pipe in the walls to accommodate a preferred fixture layout, whereas previously, the layout may have required modification due to shorter permissible distances and floor-plan constraints.

Wiring in Wet Locations: § 3280.808(k)

This change allows for any approved conduit or raceway where outdoor and under-chassis line voltage wiring is exposed to moisture or physical damage. Previously, only rigid metal conduit was permitted. This change affects wiring installed as an add-on at the factory or in the field during closeup and will decrease upfront costs due reductions in both material and labor. The decrease in cost ranges from \$57 to \$138 per home. HUD estimates that between 10 and 30 percent of homes will realize these savings. In the aggregate, expected savings will range from \$2,055,300 to \$6,165,900 per production year. In addition to lower upfront production costs, this change may also streamline site installation of homes that require additional wiring.

Multi-Unit Dwelling Manufactured Homes³

This change allows for the construction of up to three units in a single manufactured home. Currently, the code allows for a single dwelling unit. Although HUD has not estimated the number of multi-unit homes to be produced each year because of this change, there will be an overall, upfront cost savings in constructing and installing two- or three-multi-unit homes compared with two or three separate single-unit homes.

Reference to American Wood Council National Design Specification for Wood Construction: § 3280 Subpart A—General (§ 3280.4) and § 3280.304 Materials

This rule change updates the reference to the National Design Specification (NDS) for Wood Construction from the 2001 to the 2015 editions. The primary change is the reduction to design values for visually graded Southern Yellow Pine lumber, which affects either the grade of wood needed for the structural element (floors, walls, and so on) or the amount of wood necessary for

³ § 3280 Subpart A—General (§§ 3280.2, 3280.4 and 3280.5); § 3280 Subpart B—Planning Considerations (§§ 3280.103(b), 3280.105(a), 3280.109(a) and 3280.115); § 3280 Subpart C—Fire Safety (§§ 3280.203, 3280.204, 3280.214, 3280.215, and 3280.216) § 3280 Subpart F—Thermal Protections (§§ 3280.510 and 3280.511); § 3280 Subpart G—Plumbing Systems (§§ 3280.603 and 3280.609(a)(2)); § 3280 Subpart H—Heating, Cooling and Fuel Burning Systems (§ 3280.705(j)); § 3280 Subpart I—Electrical Systems (§§ 3280.802 and 3280.805); § 3285.603 Water Supply.

the structural element, based on the engineering analysis using the appropriate design values for the species and grade of lumber the home manufacturer selects.

MHCC adopted this change to keep the structural integrity of manufactured homes equivalent to site-built homes. In 2010, the Southern Pine Inspection Bureau (SPIB), an independent nonprofit industry inspection agency that sets standards and conducts testing of southern pine lumber, discovered that the strength of southern pine lumber decreased. Following further testing in 2011 and 2012, SPIB revised design values for Southern Yellow Pine effective for 2013. The site-built construction industry quickly adopted these design values to avoid structural failure. Further testing since the adoption of the lower design values in 2013 confirms that the revised standards are appropriate and needed.

Following SPIB approval in 2012, the MHCC's Structure and Design Subcommittee considered the best options for dealing with the reduced design values and, in a subcommittee meeting on July 15, 2015, recommended that the full committee approve and update the referenced standard. The full MHCC approved the lower design values on December 4, 2015.

Overall, the reduced design values for the specific lumber will increase production costs by \$91 per small, manufactured home and \$704 per large, manufactured home. HUD expects that this change will affect between 50 and 80 percent of homes shipped annually; the aggregate cost of this change will range from \$21,723,904 to \$34,758,247 per production year.

Floor joists and other structural wood elements designed using the older, higher design values will not perform as well as the same joist or structural element designed using the newer, lower design values. This performance is because the newer design values account for the different strength characteristics of lumber harvested today, which uses trees matured with speed growth techniques. Without adequately accounting for the reduction in strength characteristics, failures or inadequate performance may occur. SPIB determined that the likelihood of this potential failure occurring was high enough to warrant lower design values for the site-built industry. Consequently, the site-built construction industry adopted this change through state and model codes, following the timely adoption of more recent editions of the NDS dating back to 2012.

Although HUD and the industry both acknowledge the potential for increased cost, updating to the more recent NDS provides parity with the site-built industry and will ensure that floors and other structural elements using visually graded Southern Yellow Pine lumber in manufactured homes have the equivalent strength of floors and similar components in site-built homes. Absent this change, a market failure of asymmetric information will continue to exist where the consumer is unaware of the home's weaker structural integrity. This market failure does not exist in site-built housing, because the lower design values were adopted in 2013. HUD does not have statistics on the number of homes that have needed repairs or reinforcement due to weaker floors or structural elements because the manufacturer either corrects these weaknesses, following a consumer complaint and are, therefore, not reported to HUD, or the structural systems have not experienced the design loads for which the homes were designed and may perform acceptably until such a design event happens.

Number and Location of Exterior Doors: § 3280.105(a)(2)(i)

The manufactured housing code requires each home to have two exit doors that must be remote from each other. This change allows two exit doors to be in a group of rooms in an open floor plan rather than requiring the exit doors to be in separate rooms. This change could nominally affect the production cost of a manufactured home by reducing the number of interior walls, but more importantly, this change will increase design flexibility and increase consumer choice.

Structural Design Requirements: § 3280.305(k)(2)

This change amends the definition of attic area to clarify which portions must be designed for storage, thus higher loads. Due to the current ambiguous definition, many attics are designed and built to support unnecessarily high loads. The expected decrease in cost for small, manufactured homes ranges from \$104 to \$151 per home, and the decrease for large, manufactured homes ranges from \$617 to \$766 per home. In aggregate, this change decreases upfront costs between \$3,930,419 and \$4,989,336 per production year.

Water Supply: § 3285.603(e)(1)

This change revises the requirements in the water system testing procedure section to be in accordance with the piping manufacturer's instructions, which may be lower than the current requirements in the HUD code. Current code requires water pressure of 80 pounds per square inch (psi) for at least 15 minutes, whereas some manufacturers recommend pressure of 80 psi for 10 minutes. This change will decrease the installer's onsite testing by about 5 minutes per home. According to the U.S. Bureau of Labor Statistics, the average wage of a manufactured home installer is \$17.48 per hour. HUD estimates that this change will affect between 25 and 60 percent of homes per production year. In aggregate, this change will decrease upfront costs between \$38,471 and \$92,330 per production year.⁴

Instructions: § 3280.711

This change enables manufacturers to provide appliance operating instructions with a quick response code as an alternative to the current option of paper instructions. The quick response code would be permanently affixed to appliances to ensure that the instructions match the appliance. This change would have a minimal impact on costs but is expected to benefit consumers by providing virtual instructions that are less likely to be lost.

Exhibit 1 shows, as previously discussed, that three proposed changes have the potential to increase production costs. The weighted average per-unit increase in costs ranges from \$34.12 to \$57.55. Producers likely would pass on some or all these costs to the consumer in the form of higher retail prices, likely reducing the number of manufactured homes purchased. The extent of this decrease

⁴ This provision may also reduce the amount of copper piping used in the home, which could reduce the negative health effects of copper in areas with corrosive water. For a discussion of copper pipe-related health effects, see "Review of the National Primary Drinking Water Regulation: Lead and Copper Rule Revisions," 86 FR 71574. <https://www.govinfo.gov/content/pkg/FR-2021-12-17/pdf/2021-27457.pdf>.

in purchased homes depends on the price elasticity of demand.⁵ Three studies estimate the price elasticity of demand for manufactured housing to be about -2.4,⁶ which means that a 1-percent increase in the retail price would decrease sales of manufactured homes by 2.4 percent. Based on the overall weighted average per-unit cost increase, the average sales price of \$111,900, and the annual average production of 105,400, the decrease in homes purchased annually ranges from 77 to 130 (U.S. Census Bureau, 2021).

Elimination of Alternative Construction Letters

To encourage innovation in the design and construction of manufactured homes, HUD allows manufacturers to request approval to deviate from the HUD code. To do so, a manufacturer must submit detailed design information to a Design Approval Primary Inspection Agency, or DAPIA, for review. The design information and DAPIA review is then submitted to HUD. If approved, HUD issues an Alternative Construction (AC) letter explaining the terms, including the number of homes and the time that homes may be shipped with the requested deviation. Each home typically requires an additional onsite inspection after the home is shipped and sited. On request, manufacturers must send an inspection report to HUD for each home, and manufacturers are responsible for providing cumulative shipment reports annually under each approved AC letter. Although this process was developed to encourage innovation, in recent years, HUD has issued AC letters to compensate for the slow regulatory process of approving updates to the construction and safety standards. In 2020 and 2021, HUD issued three industrywide AC letters to accommodate supply-chain shortages.⁷

This proposed rule includes three updates and one new reference standard to eliminate the need for the most currently issued AC letters. The primary benefit of these provisions is the decrease in administrative costs, which are explained in the following sections. The new ease of providing these features possibly increases the demand for manufactured housing. This expected potential increase will not have a significant effect on the demand for manufactured housing, but rather on the features chosen by households that already planned to purchase a manufactured home.

Shower Compartment: § 3280.607(b)(3)

This update will allow for roll-in and transfer-type shower compartments (accessible bathing fixtures). The current code requires the shower compartment to contain a minimum dam or threshold height. Since establishing the AC letter process in 1994, 74 manufacturers have applied for and received permission to deviate from § 3280.607(b)(3) and include accessible roll-in shower compartments. Currently, 31 active AC letters allow for a maximum of 31,100 homes to be built with accessible roll-in shower compartments. Annually, HUD approves approximately 14 requests,

⁵ The change in the equilibrium quantity of homes sold also depends on the price elasticity of supply. The combination of the two elasticities determines how much of the cost increase can be passed to the consumer. This analysis, however, assumes that the full cost is passed to the consumer. The decrease in the quantity demanded should thus be regarded as an upper bound.

⁶ See Morgan and Belknap (1982), Gates (1984), and Meeks (1993). In contrast, Marshall and Marsh (2007) estimate the price elasticity of demand for manufactured housing to be -0.48.

⁷ Industrywide AC letters addressing supply-chain problems were issued on December 16, 2020 (20-IW1-AC), May 5, 2021 (21-IW1-AC), and December 15, 2021 (20-IW2-AC).

each allowing an estimated 250 units to contain accessible shower compartments. This update will reduce the administrative cost of applying for an AC letter and the associated review and inspections. As exhibit 3 shows, this update to the code will eliminate the need to apply for an AC letter and save manufacturers \$22,585 annually, or \$90 per home.

Incorporation by Reference and Minimum Standards: § 3280.4 and § 3280.703

This provision adds a new reference standard: The 2012 version of Underwriters' Laboratories, or UL, 60335-2-40 *Household and Similar Electrical Appliances—Safety—Part 2–40: Particular Requirements for Electrical Heat Pumps, Air-Conditioners and Dehumidifiers*. Adding this new reference standard will allow manufacturers to install tankless water heaters. Homeowners are already requesting tankless water heaters, because they are more energy-efficient than traditional storage tank heaters. HUD issues approximately seven AC letters annually, each allowing an estimated 500 units to contain tankless water heaters. Currently, 14 active AC letters allow the production of 58,350 units to contain tankless water heaters. As exhibit 3 shows, allowing tankless water heaters without the need to apply for an AC letter will save manufacturers \$106,480 per year, or \$212 per home.

Appliances, Cooling: § 3280.714 0

This change updates the version of the reference document from 1989 to 2008: The American National Standards Institute (ANSI) and Air-Conditioning, Heating, and Refrigeration Institute Standard 210/240-2008 Performance Rating of Unitary Air-Conditioning and Air-Source Heat Pump Equipment. This update will allow for single package vertical units (SPVU), both air conditioners and heat pumps, that heat and cool specific rooms or areas, thus lowering energy bills by reducing the use of larger systems. HUD issues approximately 13 AC letters annually, each allowing an estimated 250 units to contain tankless water heaters. Currently, 24 active AC letters allow for the production of 53,200 units to contain SPVUs. As exhibit 3 shows, allowing SPVUs without the need to apply for an AC letter will save manufacturers \$62,535 per year, or \$250 per home.

Requirements for Windows; Egress Window Systems; Exterior Passage Doors: § 3280.403, 3280.404, and 3280.405

This change updates the reference to three standards: AAMA⁸ 1701.2 from the 1995 version to the 2012 version; ANSI Z97.1 from the 2004 version to the 2009 version; and AAMA 1702.2 from the 1995 version to the 2012 version. The change also adds AAMA/WDMA⁹/CSA¹⁰ 101/I.S.2/A440-11 North American Fenestration Standard as an alternative compliance path in the sections of the HUD code that govern windows, sliding glass doors, skylights, egress windows, and swinging exterior passage doors. Currently, manufacturers can only use windows and doors labeled specifically for use in manufactured homes. Due to supply-chain shortages that the COVID-19 pandemic caused, manufacturers requested relief from this overly restrictive requirement. In response, HUD issued two successive industrywide AC letters that removed the requirement that manufacturers use only windows and doors that were certified for use in manufactured homes.

⁸ AAMA = American Architectural Manufacturers Association.

⁹ WDMA = Window & Door Manufacturers Association.

¹⁰ CSA = Canadian Standards Association.

The industrywide AC letters allow for unlimited production, but HUD estimates that about 2,000 units per year are produced under this authority. As exhibit 3 shows, allowing these door and window features without the need to apply for an AC letter will save manufacturers \$370,333 per year, or \$185 per home.

Summary

This proposed rule updates various provisions of HUD's manufactured housing code. Most of these proposed code changes will not affect production or installation costs or provide measurable benefits. Thirteen proposed changes will affect costs for producers or installers, provide benefits to homeowners, or both. Finally, four proposed changes will eliminate the need for producers to apply for permission to provide features that are common in site-built homes and currently requested by consumers. Exhibit 4 compares the total costs and benefits of this proposed rule. The changes in costs are all one-time, upfront costs that occur at the time of production or installation. Homeowners and occupants realize the safety and structural benefits each year during the life of the home. A range of the net present value of the stream of benefits is presented during the life of the home, assuming a life of between 30 and 45 years. These periods correspond to the minimum expected life of a manufactured home, 30 years, and the average expected life of a manufactured home, 45 years.

The net increase in upfront production costs ranges from \$10.8 to \$26.0 million per production year. Of the 13 provisions that affect production or installation costs, only two definitively increase costs, and one has an ambiguous impact on costs. Two of these provisions provide ongoing safety and structural benefits during the life of the home. The net present value of the stream of benefits from the two provisions that increase cost also produce benefits that range from \$192.2 to \$251.3 million when annualized over 30 years and from \$280.8 to \$379.2 million when annualized over 45 years. Finally, savings per production year from the reduced administrative burden that is associated with AC letter application and compliance totals \$0.561 million per production year. Overall, this proposed rule produces net benefits ranging from \$166.8 to \$368.9 million per production year.

The extent to which cost increases are passed to the consumer or borne by the producer will depend on the elasticities of supply and demand. Morgan and Belknap (1982) find a high own-price elasticity for manufactured housing and a high cross-price elasticity of substitute housing, rental apartments, and conventional single-family housing. Thus, price changes can have a large effect on the quantity of manufactured homes demanded, which would discourage producers from fully passing increased costs to the consumers and may encourage passing of cost savings through lower sales prices. No empirical studies estimate the supply elasticity of manufactured housing; however, using typical estimates of site-built elasticity of supply, slightly more than one-half of the cost increase would be passed to the consumer in the form of higher retail prices.

Exhibit 4

Costs and Net Present Value of Benefits

Comparison of Upfront Costs and Net Present Value of Benefits								
	Net Present Value Calculated over 30 Years				Net Present Value Calculated over 45 Years			
	3% Discount Rate		7% Discount Rate		3% Discount Rate		7% Discount Rate	
	Low	High	Low	High	Low	High	Low	High
Net Increase in Costs of Production/Installation								
Table 1. Upfront Increase in Production/Installation Costs	\$10,833,428		\$26,003,706		\$10,833,428		\$26,003,706	
Benefits								
Table 2b. Net Present Value of Benefits	212,062,814	251,282,128	192,245,863	227,800,191	314,489,802	379,155,956	280,828,397	346,908,049
Table 3. Savings from Elimination of AC Letters per Production Year	561,933		561,933		561,933		561,933	
Net Benefits (Tables 2b + 3 minus Table 1)	\$201,791,319	\$241,010,633	\$166,804,091	\$202,358,419	\$304,218,307	\$368,884,461	\$255,386,625	\$321,466,276

AC = Alternative Construction.

Source: HUD calculations

Acknowledgments

The author thanks Teresa Payne and Jason McJury for information and technical explanations of manufactured housing production, installation, and inspection activities. Jason McJury additionally provided invaluable engineering explanations of the proposed code changes.

Author

Michael Hollar is a Senior Economist in the Public Finance and Regulatory Analysis Division of the Office of Policy Development and Research, U.S. Department of Housing and Urban Development.

References

- Gates, Howard. 1984. "Price Elasticity of Demand for Manufactured Homes." Mimeographed reproduction.
- Hall, John R., Jr. 2013. *Manufactured Home Fires*. Quincy, MA: National Fire Protection Association, Fire Analysis and Research Division. <https://www.nfpa.org/-/media/Files/News-and-Research/Fire-statistics-and-reports/Building-and-life-safety/osmanhome.ashx>.
- Marshall, Maria, and Thomas Marsh. 2007. "Consumer and Investment Demand for Manufactured Housing Units," *Journal of Housing Economics* 16 (1): 59–71.
- Meeks, Carol. 1993. "Price Elasticity of Demand for Manufactured Homes: 1961 to 1989." Mimeographed reproduction.
- Morgan, W. Douglas, and Andrew Belknap. 1982. "The Determinants of Mobile Home Shipments: Time Series Evidence," *Business Economics* 30–37.
- U.S. Census Bureau. 2021. "Census of Manufactured Housing."
- U.S. Department of Transportation (DOT). 2021. Memorandum to Secretarial Officers Modal Administrators. <https://www.transportation.gov/sites/dot.gov/files/2021-03/VSL%20Update%202021%20-%20Transmittal%20Memo.pdf>.

Industrial Revolution

Every home that is built is a representation of compromises made between different and often competing goals: comfort, convenience, durability, energy consumption, maintenance, construction costs, appearance, strength, community acceptance, and resale value. Consumers and developers tend to make tradeoffs among these goals with incomplete information which increases risks and slows the process of innovation in the housing industry. The slowing of innovation, in turn, negatively affects productivity, quality, performance, and value. This department piece features a few promising improvements to the U.S. housing stock, illustrating how advancements in housing technologies can play a vital role in transforming the industry in important ways.

A Cost-Benefit Analysis of FORTIFIED™ Home Designation in Oklahoma

Somik Ghosh
Ben F. Bigelow
Alexander Smith
Olayinka Omole
University of Oklahoma

Abstract

Natural disasters such as hurricanes, tornadoes, and thunderstorms with high winds and hail occur worldwide. These disasters bring a proportional amount of strife in the forms of injury, property damage, and loss of life. Homeowners can take measures to protect their properties and interests, but at an additional cost, one of which comes from the Insurance Institute for Business & Home Safety (IBHS). It is FORTIFIED™ home designation, which is a collection of construction requirements regarding certification and designation. This study sought to identify the cost associated with meeting FORTIFIED home standards, then investigate its return on investment. Depending on a homeowner's financial approach, some levels of FORTIFIED home designation have a return on investment even if a natural disaster does not occur; however, it is not universal.

Introduction

The year 2021 witnessed an estimated insured loss of \$145 billion in the United States due to natural disasters (Walsh, 2022). Of those losses, Hurricane Ida was the single most damaging at \$75 billion (Smith, 2022). In terms of natural disasters, 2021 was among the top three costliest and deadliest years in the past 5 decades (Smith, 2022; Walsh, 2022). Given the considerable costs associated with natural disasters, it is important to note that for every dollar spent on disaster mitigation design, approximately four times of that amount can be saved when a disaster occurs (Szoke, 2014). Not only monetarily but also with lives at stake, the design and construction of buildings that can mitigate those risks are substantially beneficial. FORTIFIED home is a program that has risen from this need and has shown to be effective in mitigating losses from natural disasters.

The FORTIFIED home program comes from the Insurance Institute for Business & Home Safety (IBHS). The IBHS is a nonprofit research organization that property insurers and reinsurers support. The organization seeks to raise consumer awareness and advance public policy action toward preventing avoidable property losses (FORTIFIED, n.d.a.). Those aims are achieved through ongoing research into mitigation strategies against threats from natural disasters. The FORTIFIED home program is a product of that research and is a collection of standards and certification processes by which new and existing homes can be designated and constructed as “FORTIFIED” (FORTIFIED, n.d.a.). IBHS’s interest is largely financial, as the institute seeks to mitigate claims paid. However, it shares in the savings, because homes with the FORTIFIED designation qualify for a homeowner’s insurance discount. In the state of Oklahoma, that potential discount is particularly important, because Oklahoma has the highest homeowner’s insurance rates in the country. On average, Oklahoma homeowners pay 168 percent more for the same coverage as homeowners in any other state in the United States (Bankrate, 2022).

Currently, 24 designations are available through the FORTIFIED home program. They are divided into three broad categories: FORTIFIED Roof, FORTIFIED Silver, and FORTIFIED Gold. Under the three categories are additional subcategories: hurricane, high wind, hurricane and hail, and high wind and hail. This study considered specifications related to the high wind and high wind and hail subcategories. In the context of this article, FORTIFIED refers to the high wind and hail subcategory, because it is the most applicable to Oklahoma weather. Exhibit 1 summarizes the basic requirements for each of the levels of designation.

Exhibit 1

Summary of Requirements for Each Level of Designation

Designation Level	3/8" Oriented Strand Board or Plywood Decking*	7/16" Oriented Strand Board or Plywood Decking†	Roof Framing Members Designed for Minimum Wind Speed of 130 mph (Gold Only)	Use Minimum 8D x 2 3/8" Shank Nails With Minimum 1" Plastic or Metal Nail Caps	Use Minimum 8D x 2 3/8" Ring Shank Nails With Minimum 1" Plastic or Metal Nail Caps	Properly Sealed Roof Deck	Code Minimum Drip Edge	Fasteners Spaced at 6" on Center Along Laps and 12" on Center Vertically and Horizontally in the Field	Acceptable Impact Rating for Skylight(s)‡	Photovoltaic Systems Conform to Specific Installation Requirements	Appropriately Pressure-Rated Garage Doors§	Gable End Wood Structural Panel Wall Sheathing 7/16" Minimum	Attached Structures Have Adequate Connections to Prevent Uplift Pressures¶	Prescriptive Continuous Load Path for Wood Framing	Asphalt Shingles With IBHS Rating of "Excellent" or "Good"***	Adequate Bracing for Chimney Structures**
Roof—high wind	X			X		X	X	X				X				
Roof—high wind and hail	X			X		X	X	X				X			X	
Silver—high wind	X			X		X	X	X			X	X	X			X
Silver—high wind and hail	X			X		X	X	X	X	X	X	X	X		X	X
Gold—high wind		X	X		X	X	X	X			X	X	X	X		X
Gold—high wind and hail		X	X		X	X	X	X	X	X	X	X	X	X	X	X

* 3/8 inch oriented strand board or plywood qualifies for a designation only if the spacing of the roof framing is 16 inches on center or less. (Plywood is preferred to oriented strand board.)

† For FORTIFIED™ Gold designation, roof framing may be 24 inches on center or less.

‡ Skylights shall meet at least one of the following rating requirements: American Society for Testing and Materials (ASTM) E 1886 cyclic pressure test requirements and an ASTM E1996 missile impact rated B, C, D, or E; or FM approved per American National Standards Institute (ANSI)/Factory Mutual (FM) 4431, with Severe Hail rating.

§ ANSI/ Door & Access Systems Manufacturers Association International) DASMA 108 or ASTM E330 (Products are tested to 1.5 times design pressure.)

¶ Attached structures.

Single-level attached structures: Roof framing must be directly connected to roof beam with metal connectors; roof beam must be directly connected to columns with metal connectors or a minimum of two bolts; columns must be connected to foundation with metal connectors or a minimum of two bolts.

Multilevel attached structures: Roof framing must be directly connected to roof beams with metal connectors; roof beam must be directly connected to columns with metal connectors or a minimum of two bolts; upper-level columns must be connected directly to either lower level columns with metal connectors or two bolts minimum or to middle-floor structural support beams with metal connectors or two bolts minimum; middle-floor beams must be attached to lower level columns, pilings, and piers with metal connectors or a minimum of two bolts; lower level columns must be directly connected to foundation with metal connectors or a minimum of two bolts or have proper embedment depth and footing specified.

** Chimneys up to 5 feet high to be anchored to the home to help spread the load and prevent tear-offs.

*** Asphalt shingles shall be tested in accordance with ASTM D7158 and meet the classification requirements listed in exhibit 1 for the design wind speed at the building site.

Source: FORTIFIED Homes website

Among homes that have the FORTIFIED designation, most (56 percent) have FORTIFIED Roof. Exhibit 2 displays the breakdown of designation levels. It is unknown why so few homes have sought the FORTIFIED Silver designation. A plausible explanation might be that FORTIFIED Gold does not require much more than is required to achieve FORTIFIED Silver designation; thus, more clients prefer to pursue the higher designation.

Exhibit 2

Breakdown of Designation Levels

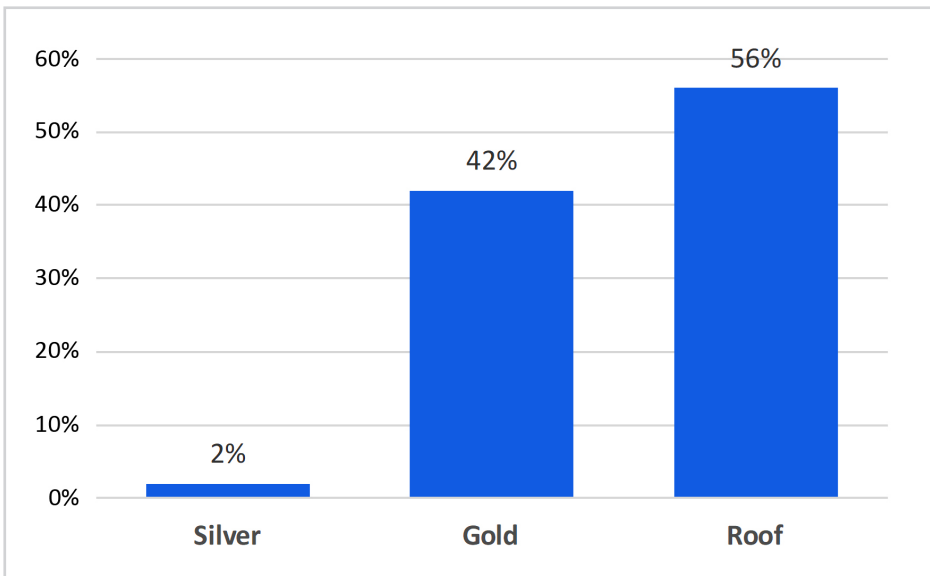

Source: FORTIFIED Homes website

Although the FORTIFIED home program has existed for many years and has more than 37,000 homes designated, its adoption has been limited to a few states. The FORTIFIED homes program is most prevalent in coastal states, but noncoastal areas like Oklahoma are also affected by weather-related disasters. More than 1,000 tornadoes are reported in the United States each year, and a considerable portion of them occur in Oklahoma (NOAA, 2021; Rauber, Walsh, and Charlevoix, 2017). Given the frequency and intensity of these severe weather events in the state, the need for mitigation measures in home design is apparent. However, as of June 2022, only 18 homes in Oklahoma had been designated as FORTIFIED. Currently, 96 percent of all homes with FORTIFIED designations in the United States are in Alabama (82 percent) and North Carolina (14 percent). Exhibit 3 displays FORTIFIED home designations by state in the United States.

Exhibit 3

Homes with FORTIFIED™ Designation in the United States as of May 2022

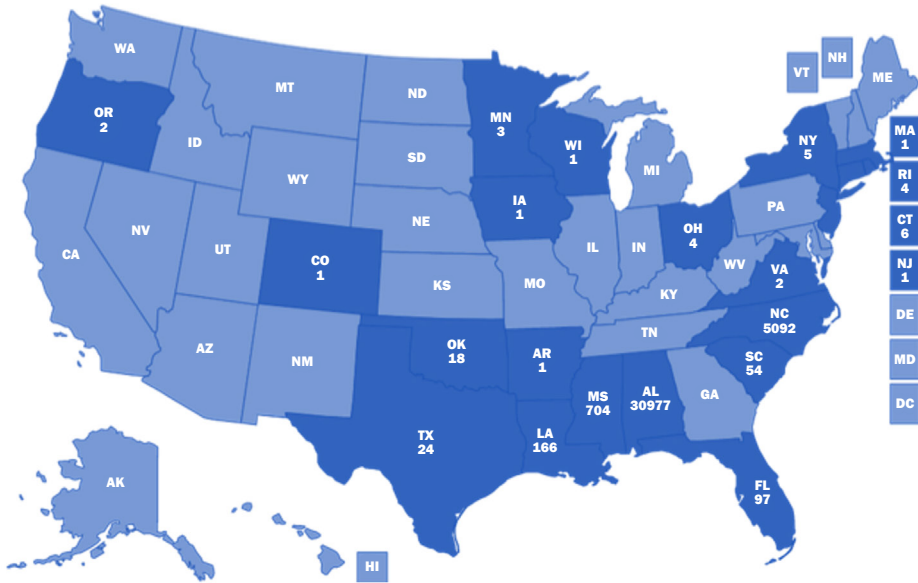

Source: Insurance Institute for Business & Home Safety, 2022

Each FORTIFIED designation comes with an increase in direct cost through labor, materials, and inspections, because the requirements are above and beyond building codes. This study aims to explore how the additional costs of the FORTIFIED home designation relates to available savings (through discounted insurance premiums). More specifically, this study seeks to determine how the FORTIFIED home designation might be a viable option for home builders to offer their clients. Specifically, the research questions this study answers are (1) What is the additional cost of FORTIFIED home designation on a typical home in Oklahoma? (2) How much time is required to recover the additional costs for FORTIFIED designation through discounted insurance premiums? (3) Can FORTIFIED home be a viable option for home builders to offer to buyers?

Methodology

A mixed-method research approach was adopted for this study, collecting both quantitative and qualitative data to understand the costs and benefits of the FORTIFIED-designated homes for homeowners and home builders in Oklahoma.

Some previous research on the FORTIFIED home program used IBHS-provided numbers to account for the additional cost of designation (Gould, 2020). According to the IBHS, a FORTIFIED home costs 3 to 7 percent more than a nondesignated house (FORTIFIED, n.d.a.). To ensure an independent evaluation of the FORTIFIED home program and given the very limited adoption of FORTIFIED home designation in Oklahoma, it was imperative that costs be quantified based on numbers specific to Oklahoma.

To provide a baseline, this study is based on four homes ranging from 1,806 to 2,483 square feet. Two production home builders built these homes, and the homes selected represent typical new construction for the Oklahoma City metropolitan area. Using these four homes, a systematic approach with a work breakdown structure tracked all FORTIFIED home requirements and the associated costs with additional labor and materials. Prices for each item were obtained through local suppliers, and labor costs were generally obtained from the RSMMeans database (RSMMeans Data, 2021).

The IBHS advertises a wide range of insurance discounts for FORTIFIED designation—from 3 to 42 percent (FORTIFIED, n.d.a.). To identify discount percentages in the Oklahoma City metropolitan area, data were first collected from insurance agents in the metropolitan area market. An online search identified insurance agents in the Oklahoma City area and returned contact information for 61 agents. Snowball sampling identified six additional insurance agents. All 67 agents were contacted for the study, and 27 interviews were conducted via telephone. The insurance agents were questioned regarding their awareness and knowledge of the FORTIFIED home program and its respective standards and designations.

Ultimately, with only 18 FORTIFIED designated homes in Oklahoma, information on available discounts could not be obtained through interviewing agents. Further, carriers closely guard insurance rate information. Therefore, homeowner's insurance premium discounts were based on an average from specific discount percentages reported by IBHS. Insurance premium rates were computed based on information from the Oklahoma Insurance Department (OID). In addition to the formal data collection and analysis conducted for this study, four interviews with FORTIFIED home professionals were conducted. Although these interviews were informal, they represent an important contribution to this study, as they provide context and depth to the collected data.

Analysis

Analysis of the data collected was conducted sequentially, beginning with the quantitative analysis of the cost to buy a new home with the FORTIFIED home designation, then the qualitative analysis of interviews with insurance agents follows, culminating with consideration of both data streams to compare costs with benefits.

Cost to Construct FORTIFIED™

In identifying the costs associated with constructing a new FORTIFIED home, the study determined the amount of the increased cost required for the respective designation levels. The additional requirements for designation were compared with the plans and specifications of the four sample homes used in the study. The cost of each category of FORTIFIED home was calculated for the four different homes, and a standard production builder's markup of 100 percent for home options was applied to derive the cost that a homebuyer would experience. The results of this analysis indicate that a FORTIFIED home designation in Oklahoma would range from 1 to 2.6 percent of the home sales price. Specifically, FORTIFIED Roof averaged 1.1 percent, FORTIFIED Silver averaged 1.6 percent, and FORTIFIED Gold averaged 2.25 percent of home sales prices. Exhibit 4 displays the full results of this cost analysis. The figures are consistent with the 1 to 3 percent cost range Gould (2020) reported but are less than the 3 to 7 percent range that the FORTIFIED program director provided (Malik, 2021).

Exhibit 4

Additional Cost of FORTIFIED™ Home Designation, Including Builder Markup

House	Base Sale Price	FORTIFIED Roof Cost	%	FORTIFIED Silver Cost	%	FORTIFIED Gold Cost	%
1-1806 SF	\$274,395	\$3,122	1.03	\$4,781	1.63	\$6,982	2.4
2-2,026 SF	\$357,125	\$4,157	1.05	\$5,717	1.52	\$7,928	2.14
3-2,343 SF	\$432,430	\$4,434	1.00	\$6,094	1.34	\$8,304	1.85
4-2,483 SF	\$295,058	\$4,144	1.30	\$5,804	1.87	\$8,015	2.61
Average			1.1		1.6		2.25

SF = square feet.

Source: Cost estimated by authors

Insurance Agents and Carriers

The study conducted semi-structured interviews with 27 independent insurance agents to consider the payback for the additional cost required for a home with the FORTIFIED designation. The interviews were intended to identify the discounts in homeowner's insurance available for FORTIFIED home designation and agents' familiarity with the FORTIFIED home program. However, the interviews also provided context regarding the limited adoption of FORTIFIED in Oklahoma. In the interview process, it quickly became apparent that most agents (67 percent) were completely unaware of the program.

In the absence of actual market data on insurance premium discounts offered to homes designated as FORTIFIED in Oklahoma, the study used IBHS-provided data to consider the financial benefit of FORTIFIED home designation. On its website, FORTIFIED lists discounts available from 11 insurance carriers, and it reports that the discounts range from 3 to 42 percent (FORTIFIED, n.d.b). The mean for the reported discounts was 18 percent (mode and median of 15 percent). Exhibit 5 displays the discounts available in Oklahoma, according to the IBHS.

Exhibit 5

Insurance Discounts Offered for Designated FORTIFIED™ Homes by Insurance Carrier

Oklahoma Insurance Discounts	
Armed Forces Insurance Exchange	15%
Employers Mutual Casualty Company	15%
Foremost Insurance Company	10%
Goodville Mutual Casualty Company	20%
IDS Property Casualty Insurance	20%
National Security Fire and Casualty	42%
Nationwide Mutual Fire Insurance Company	6%
QBE Insurance Group	3%
Shelter Mutual Insurance Company	14%
State Farm Insurance Companies	30%
Union Mutual Insurance Company	25%

Source: FORTIFIED, n.d.b.

Given the range of discounts reported, for the cost-benefit analysis calculation, discounts of 10, 15, and 20 percent were applied to reflect the range of potential discounts and the differences in discounts between Roof, Silver, and Gold designations. The 10 percent discount was applied for Roof, 15 percent for Silver, and 20 percent for Gold. Because of the absence of data from insurance carriers specifying their levels of discount, the 10-, 15-, and 20-percent discounts for each level's FORTIFIED designation are assumed. Regardless of the discount applied, the specific insurance carrier plays a significant role in whether a financial return on investment for FORTIFIED home designation is achieved.

Cost-Benefit Analysis of FORTIFIED™ Homes

The average annual cost of a homeowner's insurance policy in Oklahoma is based on information from the Oklahoma Insurance Department. Although it does not represent exact costs, it is the closest and most reliable data on insurance costs available. According to OID, a frame-structure home in the Oklahoma City area with the following coverage amounts ranges from \$1,965 to \$7,428 among 20 different insurance carriers (OID, 2022).

- 80 percent of dwelling = \$250,000.
- \$1,000 deductible.
- \$125,000 contents.
- \$100,000 personal liability.
- \$1,000 medical expenses.

Mean and median premiums were \$4,380 and \$4,533, respectively. Because these parameters did not represent the exact value of any of the four homes used in this study, a homeowner's insurance premium was computed using the mean and median premium costs from OID to arrive at \$0.0176 per \$1.00 of dwelling value. Dwelling value was determined by taking 80 percent of the sales price. Further, because insurance premiums are related directly to the value of the real property and real property generally appreciates at approximately 3 percent a year, the annual savings calculated were increased 3 percent yearly to reflect increasing home values, thus, increasing home premiums. As premiums go up, the dollar value of savings also increases.

Given inflation, opportunity cost, and the uncertainty of future payments, the time value of money asserts that \$1 received today is worth more than \$1 received in the future because of the dollar's potential earning capacity. Investors are aware of this principle when choosing how to allocate capital expenditures—especially during long periods. This study is primarily a cost-benefit analysis, so the future value of the additional cost of FORTIFIED designation had to be considered, because that money has potential earning capacity if not spent on designation requirements. Four different interest rates were modeled for 15 years to consider future value, such as 0 percent as if the money were simply spent elsewhere; 1.9 percent, the rate of a U.S. Department of Treasury note; 5 percent, a conservative investment return; and 10 percent, an aggressive investment return.

To consider the return on investment for FORTIFIED™ home designation, the future value of the additional cost to meet FORTIFIED standards, along with a reinspection cost of \$300 every 5 years, was subtracted from the cumulative homeowner's insurance premium savings to consider the financial impact on a yearly basis and allow for the identification of a breakeven point. Homeowners, who do not actively invest when expected interest rates are 0 or 1.9 percent, can recover the costs of FORTIFIED designation in years 7, 8, or 9, depending on the designation. For a conservative investor who expects a return of 5 percent, it takes 13 or 14 years to recover the cost of designation. However, when considering future value with an interest rate of 10 percent, the homeowner gains no recovery of the cost of designation through insurance premium savings.

Conclusion

The analysis section of this article addressed the first two research questions: What is the additional cost of FORTIFIED home designation on a typical home in Oklahoma? And, how much time is required to recover the additional costs of FORTIFIED designation through discounted insurance premiums? However, the third question is less obvious: Can FORTIFIED homes be a viable option for homebuilders to offer buyers? From a purely financial standpoint, a homeowner who can realize a return of 10 percent or greater on investments would require a natural disaster to recover the cost of FORTIFIED home designation. The potential exception here would be an insurance discount greater than those modeled (10, 15, and 20 percent) or a reduction in cost to meet the designation requirements. However, we have not accounted for the intangible benefit of reduced content loss for homeowners of FORTIFIED-designated homes and the less hassle of home repairs in the aftermath of a natural disaster.

Although most of the additional costs associated with FORTIFIED requirements are unlikely to decrease, two costs remain that production builders could reduce. Nearly one-third of the additional cost of FORTIFIED Gold designation is attributable to the engineering required to confirm the continuous load path. Although custom home builders must pay the engineering fee for every house they build, production homebuilders should be able to pay the engineering fee only once for one type of floor plan, then build it multiple times. This type of economy of scale could represent a significant cost reduction, thereby increasing the appeal of the FORTIFIED Gold designation.

The data suggest that regarding research question three, a production homebuilder is best equipped to offer FORTIFIED home as an option—and profit from it. A production builder can leverage the weather events common to Oklahoma, use economy of scale to reduce costs, and increase the return on investment during a typical homeownership period. According to the National Association of REALTORS® (2020), the average homeowner stays in a home for more than 13 years, which gives adequate time to realize a return through insurance premiums alone. For small, low-volume and custom builders, the viability of FORTIFIED home designation as an option is related directly to the individual customer. Weather events, as in Oklahoma, will almost certainly evoke interest. However, whether buyers opt for FORTIFIED designation or spend money on different options likely will depend on how they manage personal finances, on whether they have been victims of severe weather events, and their insurance carriers.

The outcome of the analysis implies that the only return on investment from the FORTIFIED™ home designation is a result of a reduction in homeowner's insurance premiums. However, that would ignore the returns available in the event of a natural disaster. A natural disaster that causes damage requiring an insurance claim would result in a very different return on investment. By avoiding a deductible payment and potentially increased premiums from making a claim, a homeowner's realized financial savings would offset a significant portion of the cost of FORTIFIED designation. The associated hassles of home repair would also be avoided, representing additional value. Further, a homeowner who has previously experienced a natural disaster is likely to see greater value in claim and repair avoidance. These variables are real and have differing levels of value based on individual homeowners. This analysis did not consider natural disasters because they are unpredictable.

Acknowledgments

The authors would like to acknowledge Mr. Fred Malik, Managing Director of FORTIFIED, for sharing information on the FORTIFIED programs that has benefitted this article.

Authors

Somik Ghosh is an associate professor at the Haskell and Irene Lemon Construction Science Division in the Gibbs College of Architecture at the University of Oklahoma. Ben F. Bigelow is the director and associate professor at the Haskell and Irene Lemon Construction Science Division in the Gibbs College of Architecture at the University of Oklahoma. Alexander Smith is a graduate research assistant at the Haskell and Irene Lemon Construction Science Division in the Gibbs College of Architecture at the University of Oklahoma. Olayinka Omole is a graduate research assistant at the Haskell and Irene Lemon Construction Science Division in the Gibbs College of Architecture at the University of Oklahoma.

References

- Bankrate. 2022. "Best Homeowners Insurance in Oklahoma of 2022." <https://www.bankrate.com/insurance/homeowners-insurance/oklahoma/>.
- FORTIFIED. n.d.a. "Financial Incentives." <https://fortifiedhome.org/incentives/>.
- FORTIFIED. n.d.b. *Build FORTIFIED Oklahoma Insurance Discounts*. https://fortifiedhome.org/wp-content/uploads/fortified-discounts_OK.pdf.
- Gould, Leslie S. 2020. "The Effect of FORTIFIED Home Designation on Property Value." Ph.D. diss., Department of Agricultural Economics, Mississippi State University.
- Insurance Institute for Business & Home Safety (IBHS). 2022. "FORTIFIED Monthly Update, May 2022." <https://ibhs.org/fortified/fortified-monthly-update/>.

Malik, Fred. 2021. Personal communication (interview). Managing Director of FORTIFIED, Vero Beach, FL, USA.

National Association of REALTORS®. 2020. “How Long Do Homeowners Stay in Their Homes?” *Economists’ Outlook* blog, February 8. <https://www.nar.realtor/blogs/economists-outlook/how-long-do-homeowners-stay-in-their-homes>.

National Oceanic and Atmospheric Administration (NOAA). 2021. “Tornadoes—October 2021.” National Centers for Environmental Information (NCEI). <https://www.ncdc.noaa.gov/sotc/tornadoes/202110>.

Oklahoma Insurance Department (OID). 2022. “Home Insurance Rate Comparison.” <https://www.oid.ok.gov/consumers/insurance-basics/home-insurance-rate-comparison/>.

Rauber, Robert M., John E. Walsh, and Donna J. Charlevoix. 2017. *Severe and Hazardous Weather: An Introduction to High Impact Meteorology*. Dubuque, IA: Kendall Hunt.

RSMeans Data. 2021. “Building Construction Cost Data.” <https://www.rsmeansonline.com>.

Smith, Adam. 2022. “2021 U.S. Billion-Dollar Weather and Climate Disasters in Historical Context.” <https://www.climate.gov/news-features/blogs/beyond-data/2021-us-billion-dollar-weather-and-climate-disasters-historical>.

Szoke, Stephen S. 2014. “Building Code Modifications for Enhanced Resiliency,” *International Journal of Critical Infrastructures* 10 (1): 52–66. <https://doi.org/10.1504/IJCIS.2014.059540>.

Walsh, Joe. 2022. “U.S. Natural Disasters Cost \$145 Billion In 2021—3rd-Costliest Year on Record,” *Forbes*, January 10. <https://www.forbes.com/sites/joewalsh/2022/01/10/us-natural-disasters-cost-145-billion-in-2021---3rd-costliest-year-on-record/?sh=3454f9664606>.

Additional Reading

Awondo, Sebastain, Harris Hollans, Lawrence Powell, and Chip Wade. 2019. *Estimating the Effect of FORTIFIED Home™ Construction on Home Resale Value*. Tuscaloosa, AL: The University of Alabama.

Burgess, Donald, Kiel Ortega, Greg Stumpf, Gabe Garfield, Chris Karstens, Tiffany Meyer, Brandon Smith, Doug Speheger, Jim Ladue, Rick Smith, and Tim Marshall. 2014. “20 May 2013, Moore, Oklahoma, Tornado: Damage Survey and Analysis,” *Weather and Forecasting* 29 (5) 1229–1237. <https://doi.org/10.1175/WAF-D-14-00039.1>.

Fratinardo, Vincent F., and Scott A. Schroeder. 2014. “Lessons Learned: How Changes in Code, Construction and Preparedness Affected Tornado Damage in Moore, Oklahoma, 1999 to 2013.” <https://doi.org/10.1061/9780784413357.122>.

Insurance Institute for Business & Home Safety (IBHS). n.d. “Why IBHS?” <https://ibhs.org/about-ibhs/>.

Insurance Institute for Business & Home Safety. 2014. "Relative Impact Resistance of Asphalt Shingles: Summary of UL 2218 Impact Tests." https://ibhs.org/wp-content/uploads/member_docs/Relative-Impact-Resistance-of-Asphalt-Shingles_IBHS.pdf.

LaFave, James M., Zhengboyang Gao, Donovan E. Holder, Michael J. Kuo, and Larry A. Fahnestock. 2016. "Commercial and Residential Building Performance During the May 20, 2013, Tornado in Moore, Oklahoma," *Journal of Performance of Constructed Facilities* 30 (2): 04014210. [https://doi.org/10.1061/\(ASCE\)CF1943-5509.0000722](https://doi.org/10.1061/(ASCE)CF1943-5509.0000722).

Ramseyer, Chris, Royce Floyd, and Lisa Holliday. 2017. "Performance of Enhanced Residential Building Code Requirements During the March 25, 2015, Moore Tornado," *Journal of Performance of Constructed Facilities* 31 (5): 04017087. [https://doi.org/10.1061/\(ASCE\)CF1943-5509.0001070](https://doi.org/10.1061/(ASCE)CF1943-5509.0001070).

Simmons, Kevin M., Paul Kovacs, and Gregory A. Kopp. 2015. "Tornado Damage Mitigation: Benefit–Cost Analysis of Enhanced Building Codes in Oklahoma," *Weather, Climate, and Society* 7 (2): 169–178. <https://doi.org/10.1175/WCAS-D-14-00032.1>.

Y Charts. n.d. "10 Year Treasury Rate." https://ycharts.com/indicators/10_year_treasury_rate.

Concept of Thermal Bridging in Wood Framed Construction

Shawn P. Kelley

Moment Engineering + Design

Mike Blanford

U.S. Department of Housing and Urban Development

The views expressed in this article are those of the authors and do not represent the official positions or policies of the Office of Policy Development and Research, the U.S. Department of Housing and Urban Development (HUD), or the U.S. Government.

Abstract

Thermal bridging through wood framing accounts for significant energy loss in an insulated wood-framed wall assembly. The Model Energy Code has been silent on thermal bridging in wood-framed construction and instead has focused on the R-value of the insulation within the wall cavity. For the first time, the 2021 International Energy Conservation Code (IECC) will now require continuous insulation as a part of the wood-framed wall requirements in colder climates. A common solution to this requirement is to place a layer of rigid foam insulation on the exterior of the wall assembly; however, the code allows for alternative methods, providing an opportunity for innovation.

Introduction

The second law of thermodynamics specifies that hot things cool unless something is done to stop it. Some people may have experienced this with their morning cup of coffee. If using a thin-walled cup without a lid, the coffee cools rapidly. If one wishes to keep the coffee hot until later in the day, using a double-wall insulated thermos with an airtight lid will keep the coffee hot. The thermos is much more energy efficient—it keeps the heat in place.

Likewise, the walls, floors, roof, and foundation surrounding homes are all potential sources of heat loss. Reducing the migration from hot to cool (i.e., improving the energy efficiency of homes) is especially important when considering the impact homes have on total energy usage. According

to the U.S. Department of Energy, energy use in residential homes accounts for about 21 percent of total U.S. energy consumption, and more than one-half of that energy is spent heating and cooling homes (EIA, 2015).

Using the coffee analogy, when the thin-walled cup holding the coffee is too hot to the touch, the heat of the coffee is transferred directly through the cup into one's fingers. To reduce this effect, one can slip a cardboard sleeve around the cup or use a Styrofoam cup (except in those states where Styrofoam has been banned for decades already), and the cup can be easily held without feeling the heat of the liquid inside. The Styrofoam cup and the cardboard-sleeve-wrapped cup have more thermal resistance than the unwrapped paper cup. In home construction, thermal resistance is measured by R-value. The higher the R-value, the greater the insulating power.

Understanding these concepts is the first step in improving energy efficiency in our homes (exhibit 1).

Exhibit 1

Diagram of Thermal Bridging

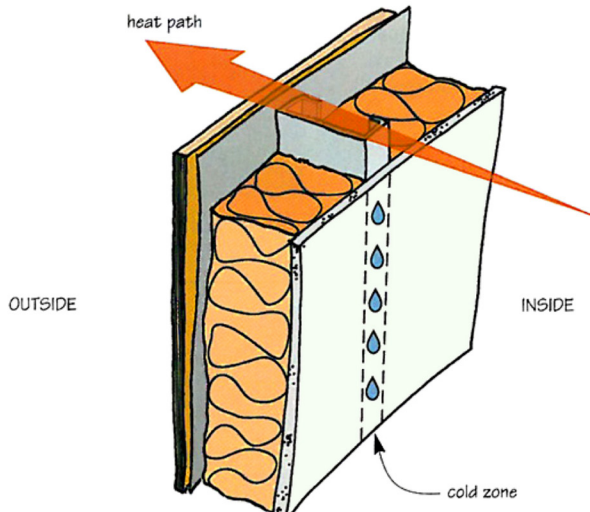

Source: Civil Engineering

Concept of Thermal Bridging in Homes

Most people are familiar with cavity insulation (typically fiberglass batt) that is used in the walls and ceilings of wood-framed construction, but it is the wood framing that tends to conduct the heat out of the house because of the poor insulative value of wood. In wood-framed construction, the R-value of wood studs is R1.25 per inch, whereas fiberglass insulation is R3.3 per inch (Bres, 2009). The heat seeks the path of least resistance, and the path of least resistance—where the heat tends to flow—is called a thermal bridge. Thermal bridges develop where the wood studs are located because the wood is more conductive to heat than the other materials around it, resulting

in higher heat loss. The wood frames are like the coffee cup without a sleeve. The thermal bridging of wood framing is evident in an infrared photograph (exhibit 2).

Exhibit 2

Infrared Photograph of a Wood-Framed House



Source: Applied Building Technology Group

How many thermal bridges are in a typical wall? Building scientists developed the term *framing factor*, which is the ratio of the area of the wall made up of wood studs to the total wall area (Kosny et al., 2006). A typical wood-framed home might have a framing factor as high as 25 percent (Lstiburek, 2010). For an energy-efficient home built using advanced framing techniques, the framing factor might be 15 percent. In fact, heat loss through framing members such as studs, headers, and sill plates could account for as much as 30 percent of the total heat loss in a wood-framed wall assembly. Minimizing or eliminating thermal bridging presents a substantial opportunity for energy savings for heating or cooling.

New Energy Code Requirements

To address thermal bridging, Section R402.1.2, Insulation and Fenestration Criteria, of the 2021 International Energy Conservation Code (IECC) now requires continuous insulation in addition to wall cavity insulation in colder climates (ICC, 2021). Continuous insulation provides a thermal break over all framing members on either the interior or exterior of the wall assembly. This process is similar to adding a cardboard sleeve or a layer of Styrofoam insulation to the coffee cup. Most commonly, a 1-inch layer of rigid foam insulation (R5) is applied on the exterior of the home, a method known as continuous foam insulation. The exterior insulation minimizes the effects of

thermal bridging by preventing heat flow through the wood stud directly to the outdoors; however, as discussed below, continuous foam insulation is not the only solution.

Current Solutions Using Continuous Foam Insulation

Several insulated sheathing products on the market incorporate a foam layer as part of the structural wall sheathing. With these products, the structural sheathing and continuous insulation layer are all incorporated into one product and installed like typical plywood or oriented strand board (OSB) sheathing on the exterior face of the stud wall (exhibit 3).

Exhibit 3

Insulated Sheathing Boards



Source: Huber Engineered Woods

Structural insulated panel (SIP) construction is another method that satisfies continuous insulation requirements (see Blanford, 2009). SIPs are sandwich panels constructed with a core of expanded polystyrene foam insulation between an interior and exterior layer of plywood or OSB. SIP walls do not have studs within the wall cavity; instead, they are composed of continuous panel segments connected with a few wood studs at panel joints.

Both construction methods are examples of continuous sheets of rigid foam that create a thermal break. The methods comply with the prescriptive R-value insulation requirements of the code.

Alternatives to Continuous Foam Insulation

The 2021 IECC Table R402.1.2 allows an alternative method of compliance to prescriptive R-value insulation. This method looks at the overall effectiveness of a wall assembly by quantifying a maximum U-factor for compliance. U-factor is often expressed as the reciprocal of the R-value; a lower U-factor is more effective in reducing thermal transmittance. The U-factor of a wall assembly is determined by measuring the relative contribution of thermal transmittance, considering the different R-values of the individual materials. In the case of a wood-framed wall, the thermal properties of each construction element (the drywall, studs, cavity insulation, exterior sheathing, house wrap, air sealing, and siding) are all added up and considered a part of the overall thermal effectiveness of the wall assembly.

Using the more detailed approach of determining the U-factor for a wall assembly, builders can use innovative new building components to comply with the energy code without the need for continuous sheets of foam insulation material. One such innovation is the use of insulated studs, headers, and sill plates to replace conventional wood material when constructing exterior walls. Insulated stud products such as Insul-Stud™ help to create a thermal break within the wall cavity, thereby eliminating the need for added foam layers outside it. The insulated studs are constructed using two pieces of wood separated by a dense core of closed cell insulation, forming a structural composite material. A 2-inch by 6-inch Insul-Stud™ has an R19 insulation value, whereas a conventional wood stud is about an R7. In addition to the higher R-value, these studs use 40 percent less wood and are 60 percent lighter than a wood stud while still having the same strength as a regular wood stud (exhibit 4).

Exhibit 4

Insul-Stud™ Brand of Insulated Studs



Source: Insul-Stud™

Comparative Analysis of Insulated Studs vs. Continuous Foam

One drawback of using continuous foam insulation on the exterior of a building is the cost associated with the additional material and labor required to install it. In one example, the cost to install a 1-inch layer of continuous foam insulation on the exterior of an average single-family dwelling was approximately \$2 per square foot. In addition to the material and installation costs for the insulation, builders have to consider door and window moldings that would be required for the increased wall thickness.

Depending on the product used, the foam layer could also affect the lateral strength of the building and require specialty fasteners that are long enough to extend through the added insulation layer into the framing. These fasteners penetrate the insulation layer, causing thermal bridging through the continuous insulation layer at stud locations, thereby reducing the effectiveness of the wall assembly.

With insulated studs, the need for expensive exterior rigid foam is eliminated, and exterior sheathing and finishes can be installed as they would with wood studs. Another benefit is that the metal fasteners used to install exterior sheathings and finishes will not create a thermal bridge at stud locations because the core of the studs creates a thermal break. The insulated studs are an easy replacement for wood materials, with no additional installation costs, and are much lighter and straighter than a wood stud, making installation easier. In addition, the web material is easy to drill through, simplifying the installation of electrical and plumbing lines, and because the continuous insulation is accomplished with the wall cavity, using this product to meet code requirements provides no added wall thickness.

Another use for insulated studs is in net-zero construction. Using insulated studs in combination with other enhanced insulation products (such as continuous exterior foam insulation and closed-cell spray foam in the wall cavity) can yield a high-performance, energy-efficient exterior wall using a minimal wall thickness.

Conclusion

At the time of publication, less than 10 percent of jurisdictions in the United States have adopted the 2021 IECC code. The authors encourage builders and homeowners unfamiliar with the new code requirements to learn more about them since exterior finish details and construction costs may be affected. Using alternative products such as Insul-Stud™ offers a drop-in solution that is interchangeable with wood studs and would require no extra steps for code compliance. In general, the new thermal bridging code requirements are a step in the right direction toward improving energy efficiency and creating a more comfortable living environment for homeowners.

Authors

Shawn P. Kelley is a professional engineer and president of Moment Engineering + Design in Vienna, Virginia. Mike Blanford is a research engineer at the U.S. Department of Housing and Urban Development.

References

- Blanford, Mike. 2009. "Structural Insulated Panels: An Alternative to Wood Frame Construction," *Cityscape* 11 (2): 113–116.
- Bres, Dana. 2009. "Framing for Strength and Efficiency," *Cityscape* 11 (3): 257–260.
- International Code Council (ICC). 2021. *2021 International Energy Conservation Code*. <https://codes.iccsafe.org>.
- Kosny, Jan, David Yarbrough, Phillip Childs, and Syed Mohiuddin. 2006. "Effects of Framing on the Thermal Performance of Wood and Steel-Framed Walls." In *Proceedings of the Fifteenth Symposium on Improving Building Systems in Hot and Humid Climates*, Orlando, FL, July 24–26, 2006. https://www.researchgate.net/publication/26901053_Effects_of_Framing_on_the_Thermal_Performance_of_Wood_and_Steel-Framed_Walls.
- Lstiburek, Joe. 2010. "BSI-030: Advanced Framing," *Building Science Insight*, March 10. <https://www.buildingscience.com/documents/insights/bsi-030-advanced-framing>.
- U.S. Energy Information Administration (EIA). 2015. *Residential Energy Consumption Survey (RECS)*. Tables CE3.1 and HC10.9. <https://www.eia.gov/consumption/residential/>.

Additional Reading

This U.S. Department of Energy webpage provides an excellent introduction to insulation and other concepts discussed in this article: <https://www.energy.gov/energysaver/insulation>.

For more on the physics of heat flow through a wall assembly, see the research report by John Straube, *Thermal Metrics for High Performance Enclosure Walls: The Limitations of R-Value*. https://www.buildingscience.com/sites/default/files/migrate/pdf/RR-0901_Thermal_Metrics.pdf.

Symposium

Housing Technology Projects 1
Guest Editors: Mike Blanford and Kent Watkins
Guest Editors' Introduction
Recent Findings and Results of Grants from the Cooperative Research in Housing Technologies Program:
Where Do They Fit Within the Framework of the Past 55 Years of Housing Technology Innovation at HUD? 3
Increasing Innovation and Affordability in Housing: A Case Study on Townhome Area Separation Walls
by *Christine Barbour and James Lyons* 17
Advanced Modular Housing Design: Developing the CORE+ by *Jeff Carney, Ravi Srinivasan, Stephen Bender,
Bill O'Dell, Ryan Sharston, Abdol Chini, and Forough Foroutan* 37
Getting Cross-Laminated Timber into U.S. Design Codes: A Must for Affordable and Sustainable Multifamily
Housing by *John W. van de Lindt, Maria Koliou, and Pouria Bahmani* 57
Designing for Natural Hazards: Resilience Guides for Builders and Developers by *John B. Peavey,
Nay B. Shah, Chinedu Moneke, Kevin Kauffman, and Elina Thapa* 71
Modeling and Analyzing Distributed Heat Pump Domestic Water Heating in Modular Multifamily Buildings
by *Victor Braciszewski, Stet Sanborn, Justin Tholen, Harshana Thimmanna, Tyler Pullen, Carol Galante,
and Jamie Hiteshe*w 89
Factory Complete Heating and Cooling Solutions for Manufactured Homes by *Emanuel Levy, Jordan Dentz,
and Yi-Jia Liao* 117
Exploring the Potential of Factory Installed Solar + Storage for Homebuilding by *Isabelina Nahmens,
Ondřej Labík, Alison Donovan, Kalee Whitehouse, Damon Lane, Desmond Kirwan, Leslie Badger,
Ankur Podder, and Shanti Pless* 145
3D Concrete Printed Houses: Barriers to Adoption and Construction Practices by *John B. Peavey,
Ed Hudson, Zachary A. Summy, and Jon Violette* 163
Seismic Design Methodology for 3D Printed Concrete Buildings by *Mohammad Aghajani Delavar,
Hao Chen, and Petros Sideris* 177
Residential House Foundations on Expansive Soils in Changing Climates by *Nafisa Tabassum and Rifat Bulut* 199

Refereed Papers 213
Moving to Problems: Unintended Consequences of Housing Vouchers for Child Welfare-Involved Families
by *Patrick J. Fowler, Andrew Foell, Anne K. Rufa, and Michael Schoeny* 215

Departments 237

Data Shop
Move-In Fees as a Residential Sorting Mechanism Within Online Rental Markets by *Remy Stewart,
Chris Hess, Ian Kennedy, and Kyle Crowder* 239

Foreign Exchange
The Role of Forbearance in Sustaining Low-Income Homeownership: Evidence from Norway's Public
Starter Mortgage Program by *Anna Maria Santiago and Kristin Aarland* 253

Graphic Detail
Neighborhood Incarceration Rate Hot Spots in Maryland by *Alexander Din* 275
Visualizing Spanish Speaking Limited English Proficiency and Hispanic Populations in Fort Collins, Colorado
by *Brent D. Mast and Tricia Ruiz* 281

Impact
Regulatory Impact Analysis of Manufactured Home Construction and Safety Standards by *Michael Hollar* 287

Industrial Revolution
A Cost-Benefit Analysis of FORTIFIED™ Home Designation in Oklahoma by *Somik Ghosh, Ben F. Bigelow,
Alexander Smith, and Olayinka Omole* 303
Concept of Thermal Bridging in Wood Framed Construction by *Shawn P. Kelley and Mike Blanford* 315

