



Department of Housing and Urban Development  
Development and Research

690.591  
R231r  
1986  
v.7

---

# Rehabilitation Guidelines 1986

U.S. Department of Housing and Urban Development  
Washington, D.C. 20410

Official Business  
Penalty for Private Use, \$300

Postage and Fees Paid  
Department of Housing  
and Urban Development  
HUD - 401



November 1986  
HUD-PDR-613-7(2)  
(Previous Edition Current)

---

DEPARTMENT OF HOUSING  
AND URBAN DEVELOPMENT

DEC - 4 1997

LIBRARY  
WASHINGTON, D.C. 20410

DEPARTMENT OF HOUSING  
AND URBAN DEVELOPMENT

DEC - 4 1997

LIBRARY  
WASHINGTON, D.C. 20410

The contents of this publication do not necessarily  
reflect the views or policies of the  
Department of Housing and Urban Development  
or the U.S. Government

690.591 R231r 1986 v.7  
National Institute of  
Building Sciences  
Rehabilitation guidelines  
1986

HUD LIBRARY



T 44375

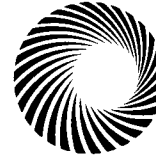

Prepared by the

National Institute of  
BUILDING SCIENCES  
Washington, D.C.

for the U. S. Department of Housing and Urban Development  
Office of Policy Development and Research  
under Cooperative Agreement H-5033

The Institute is grateful to the following organizations whose representatives participated in the development of these guidelines:

- U. S. Conference of Mayors
- National League of Cities
- National Association of Housing and Redevelopment Officials
- AFL-CIO Building and Construction Trades Council
- Association of Major City Building Officials
- National Association of Home Builders
- National Trust for Historic Preservation
- U.S. League of Savings Associations
- National Housing Rehabilitation Association
- National Home Improvement Council
- Building Code Action
- Council of American Building Officials
- National Conference of States on Building Codes and Standards
- National Fire Protection Association
- American Institute of Architects



THE SECRETARY OF HOUSING AND URBAN DEVELOPMENT  
WASHINGTON, D.C. 20410

This guideline is intended only for those who are knowledgeable about the design and installation of plumbing systems. But it should be of interest to everyone involved in the rehabilitation of America's aging housing stock because it is designed to facilitate rehabilitation when codes are in conflict with that goal.

As far as plumbing is concerned, it is obvious that a maximum re-use of existing facilities is the cost-effective way to go in residential rehabilitation. It is equally obvious that the health and sanitation needs of tenants should not be sacrificed to cost-effectiveness. The guideline mediates between the two by specifying drainage, waste, and venting problems and proposing modifications to existing codes that will satisfy tenants, code inspectors, rehabilitators, and communities desiring to renovate their decaying housing.

The quality of this guideline and the seven others in the series is the result of the invaluable efforts of Robert Kapsch, program manager for HUD's Office of Policy Development and Research; William Brenner, project manager for the National Institute of Building Sciences; and David Hattis, consultant from Building Technology, Inc.

A handwritten signature in cursive script, reading "Samuel R. Pierce, Jr.", written in black ink.

Samuel R. Pierce, Jr.  
Secretary

**FIGURE 15**

Addition of Disposer and Dishwasher to Kitchen Sink on Existing Stack

Illustration of acceptable addition of disposer and dishwasher to a 2 inch stack on every floor (see problem 2.3).

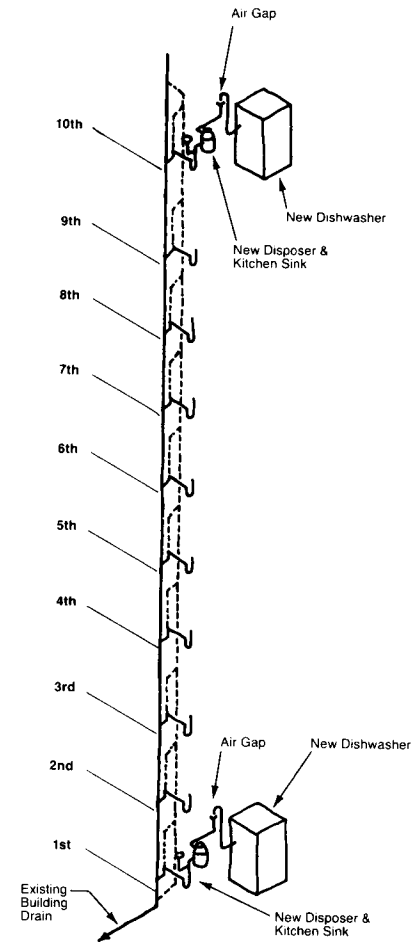

**FIGURE 14**

**Engineered Single Stack System Sized According to Published Criteria**

Illustration of possible solution to problem of the type discussed under 2.3.

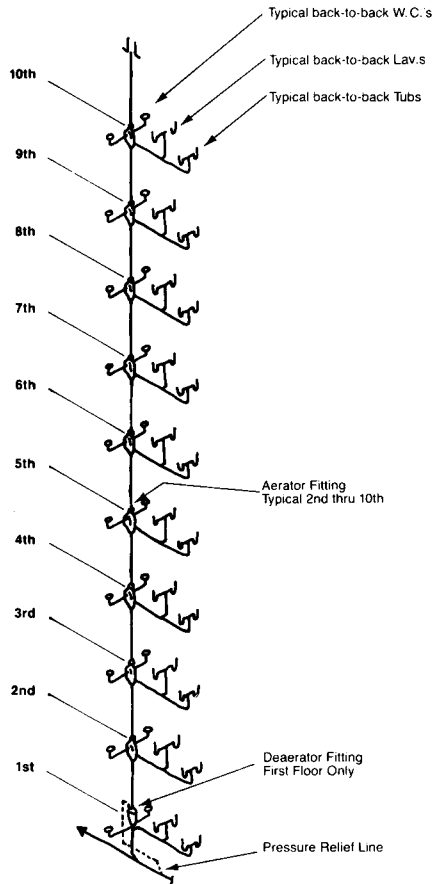

## The Rehabilitation Guideline Series

The *Rehabilitation Guidelines* were prepared by the National Institute of Building Sciences for the Department of Housing and Urban Development in response to the requirements of Section 903 of the Housing and Community Development Amendments of 1978.

As Congress intended, the *Rehabilitation Guidelines* are not a code, nor are they written in code language. Rather, they are designed for voluntary adoption and use by States and communities as a means to upgrade and preserve the nation's building stock, while maintaining reasonable standards for health and safety. The term "rehabilitation", as used in the guidelines, includes any set of activities related to the general view of existing buildings as a resource to be conserved, rehabilitated, or reused.

This initial edition of the *Rehabilitation Guidelines* is published in eight separate volumes. The first four guidelines are designed for use by building officials, members of the executive and legislative branches of government, and related commissions and organizations involved in developing or implementing building regulations. These guidelines cover the following topics:

- 1 The *Guideline for Setting and Adopting Standards for Building Rehabilitation* provides an introduction and background to the building regulations that affect rehabilitation. It describes methods for identifying regulatory problems in a community, and recommends ways to amend, modify, or supplement existing regulations to encourage rehabilitation.
- 2 The *Guideline for Municipal Approval of Building Rehabilitation* examines the inherent differences between regulating new construction and regulating rehabilitation, and presents specific recommendations for dealing with rehabilitation within municipal building departments.
- 3 The *Statutory Guideline for Building Rehabilitation* contains enabling legislation that can be directly adopted by communities to provide the legal basis for promoting rehabilitation through more effective regulation.
- 4 The *Guideline for Managing Official Liability Associated with Building Rehabilitation* addresses the liability of code officials

involved with the administration and enforcement of rehabilitation, and provides recommendations for minimizing liability problems.

The remaining four guidelines are technical in nature, and are intended for use by code officials, inspectors, designers, and builders. They cover the following topics:

- 5 The *Egress Guideline for Residential Rehabilitation* lists design alternatives for the components of egress that are regulated by current codes such as number and arrangement of exits, corridors, and stairs, travel distance, dead-end travel, and exit capacity and width.
- 6 The *Electrical Guideline for Residential Rehabilitation* outlines procedures for conducting inspections of electrical systems in existing buildings, and presents solutions to common problems associated with electrical rehabilitation such as eliminating hazardous conditions, grounding, undersized service, number of receptacle outlets, and incompatible materials.
- 7 The *Plumbing DWV Guideline for Residential Rehabilitation* presents criteria and methods for inspecting and testing existing drain, waste, and vent (DWV) systems, relocating fixtures, adding new fixtures to existing DWV systems, extending existing DWV systems, and installing new DWV systems in existing buildings.
- 8 The *Guideline on Fire Ratings of Archaic Materials and Assemblies* contains the fire ratings of building materials and assemblies that are no longer listed in current building codes or related reference standards. Introductory material discusses flame spread, the effects of penetrations, and methods for determining the ratings of assemblies not listed in the guideline.

Single editions of the *Rehabilitation Guidelines*—or copies of specific guidelines—are available at no charge, as long as supplies last, from HUD USER, P.O. Box 280, Germantown, Maryland 20767. Phone (301) 251-5154

The *Rehabilitation Guidelines* are also available from the Superintendent of Documents, U. S. Government Printing Office, Washington, D. C. 20402.

**FIGURE 13**

**Wet Venting of Tubs and Water Closets**

Illustration of possible solution to problem of the type discussed under 2.3.

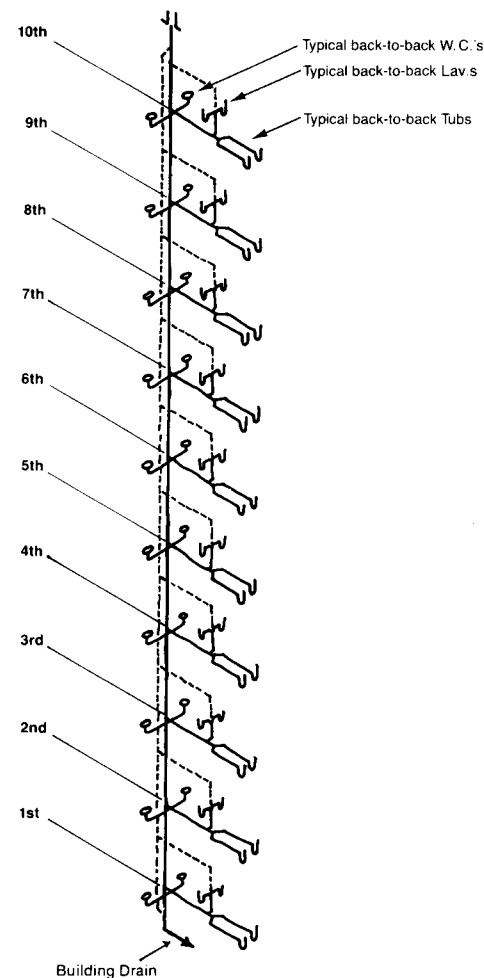

**FIGURE 12**

Typical Fully Vented Back-to-Back Bathroom Stack with Alternate Solution

Illustration of use of wet venting in solving a problem of the type discussed under 2.3.

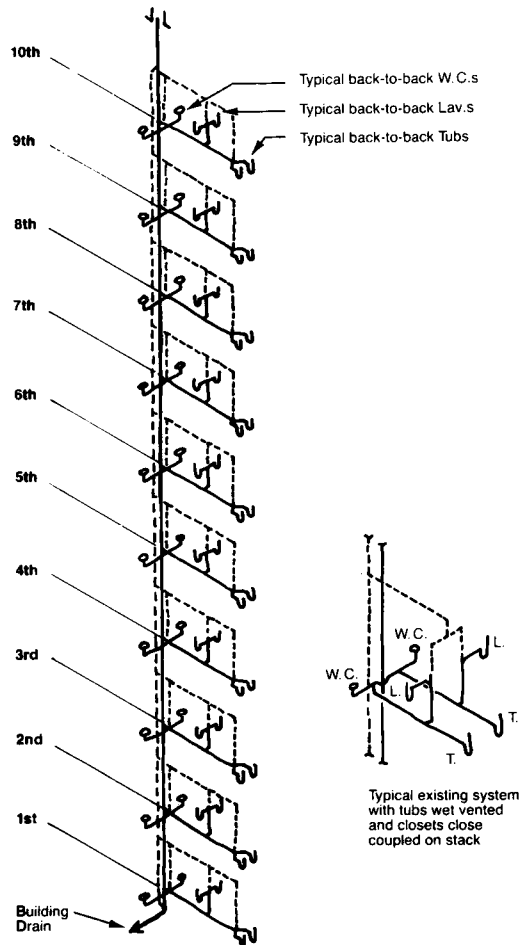

## Table of Contents

Introduction.....	1
Basic Drainage and Hydraulic Concepts..	2
1 Determination of Existing Condition of the DWV System.....	8
1.1 Inspection, System Schematics, and Preliminary Evaluation.....	8
1.2 Testing the Existing System.....	9
1.3 Estimating the Capacity of the Existing DWV System.....	13
2 Problems and Solutions (Proposed Modifications).....	14
2.1 Correcting Existing DWV System Structural, Hydraulic and Functional Defects, and Surcharged Sewers.....	14
2.2 Relocating Fixtures.....	16
2.3 Adding New Fixtures to Existing DWV Systems, Extending DWV Systems, and/or Installing New DWV Systems in Existing Buildings.....	18
2.4 Through-the-Wall Venting.....	19
Appendix A: Performance Criteria.....	20
Appendix B: Examples of Acceptable DWV Practices for Building Rehabilitation.....	26



## Acknowledgments

The material herein was prepared by the National Institute of Building Sciences on the basis of research conducted by the Davidson Laboratory, Stevens Institute of Technology. Technical reviewers for the Institute included Albert Tremari, Robert Wyly, William Tangye, George Schoonover, Wylie Mitchell, Larry Gallowin, and George Jerus.

Overall management and production of the *Rehabilitation Guidelines* was directed by William Brenner of the Institute, with David Hattis of Building Technology, Inc. the principal technical consultant. Guideline cover graphics and layouts were designed by the Design Communication Collaborative.

FIGURE 11

Addition of Second or Third Floor Bathroom Group to Existing 3-Story Stack

For possible use of single stack solutions see 1.3(4) and discussion under 2.3.

Note that for addition of new water closet, tub, and lavatory to either second or third floor, second floor may be wet vented and third floor stack vented.

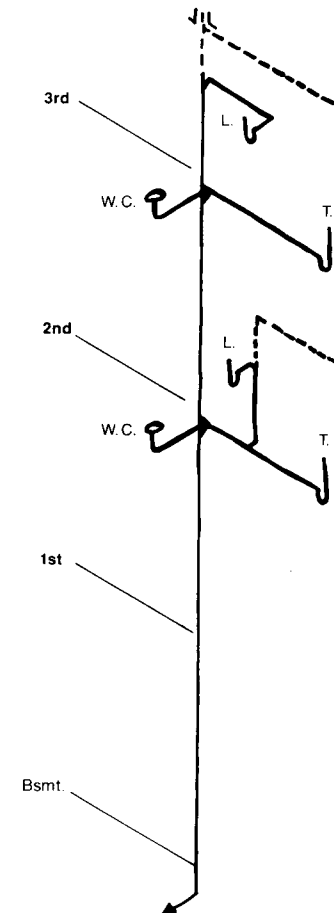

**FIGURE 10**

Addition of First Floor Powder Room to Existing 3-Story Stack

Illustration of use of wet venting in solving a problem of the type discussed under 2.3.

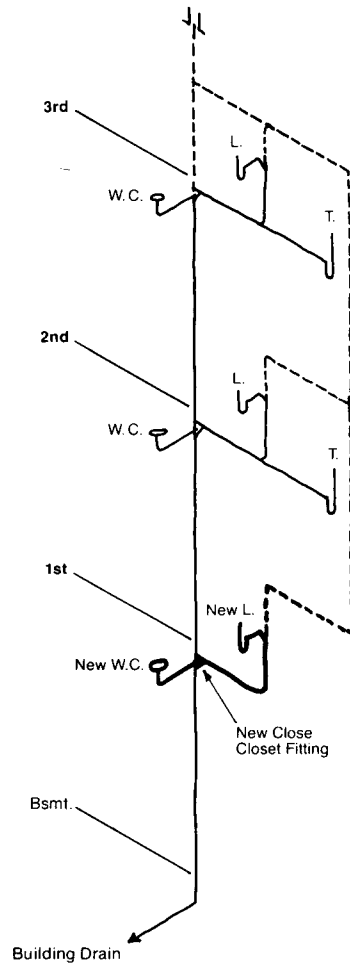

## Introduction

This guideline is applicable to all types of residential occupancies. The guideline is not a code, but like a plumbing code, it is intended for use by persons knowledgeable about building plumbing design and installation. Its use should facilitate rehabilitation in circumstances where, for some reason, code requirements for new construction are being applied to a project undergoing rehabilitation. In general, there are two such circumstances:

- Repair and improvement of existing residential buildings, when compliance with the code requirements for new construction is triggered by a 25-50% Rule or similar rule which is in effect in the jurisdiction.
- Change of use or occupancy into a residential occupancy (e.g., from one- and two-family dwelling to apartment building, office building to apartment building), when compliance with the code requirements for new construction is triggered by the provisions of the building code in effect or some other provision.

For rehabilitation involving a change of use or occupancy, this guideline should be used when it is feasible to reuse existing drainage, waste and vent (hereinafter DWV) piping in the building, or when existing structural or architectural elements in the building pose physical constraints to the installation of new DWV piping.

New construction building and plumbing code DWV requirements can be a major rehabilitation problem because extensive additional structural and finish work may be entailed when either new or existing DWV systems are made to comply fully with current code provisions. There are several aspects to this problem:

- Existing vent systems may not comply with current code provisions for pipe sizing, connections, use of wet venting, and vent location, although they may provide adequate health and safety as installed and used;
- The installation of new vents and drainage lines, even for new fixtures, may be constrained by limited available space and/or the installed configuration of the existing piping system;

- The cost-effective use of existing DWV systems in rehabilitation projects requires judgment and flexibility by building and plumbing officials to a greater extent and in a different manner than is required for new construction.

Code requirements for DWV systems are not always consistent from one state or local jurisdiction to the next. What is permitted by one code may not necessarily be permitted by another. However, the hydraulic principles underlying the functioning of plumbing systems and the potential health and sanitation hazards involved in DWV are universal.

Alternative solutions to various DWV installation problems typically encountered in residential rehabilitation are presented herein. The application of these guidelines is intended to provide a level of health and sanitation which is generally equivalent to the level intended by current DWV requirements, while facilitating the maximal re-use of existing DWV elements.

This guidelines is based upon accepted plumbing and hydraulic engineering principles in general practice and the experiences of recognized testing facilities. The synthesis of engineering principle with practical experience provides a sound basis for the judgment and flexibility necessary for successful building rehabilitation.

## Basic Drainage and Hydraulic Concepts

Because the guideline recommends greater flexibility in meeting the health and safety intent of current codes, an understanding of basic drainage and hydraulic concepts is essential to its use.

### Function of the Drainage System

The function of the DWV system is to collect spent water from the various building fixtures and drains and to convey this waste water to the public sewer or other acceptable point of discharge in a safe and efficient manner.

A "safe manner" means collection and transmission without the emission of sewer gases, foul odors, or suds into the inhabitable area of a building. Traps at the entrances to the DWV system provide water seals which prevent the escape of sewer gases.

**FIGURE 9**

Addition of Kitchen Sink and Bathroom Group to Existing 3-Story Stack

Illustration of use of stack venting in solving a problem of the type discussed under 2.3.

Kitchen sinks or bathroom groups may be added to an existing wet vented stack (4" stack required) of not more than three floors in height.

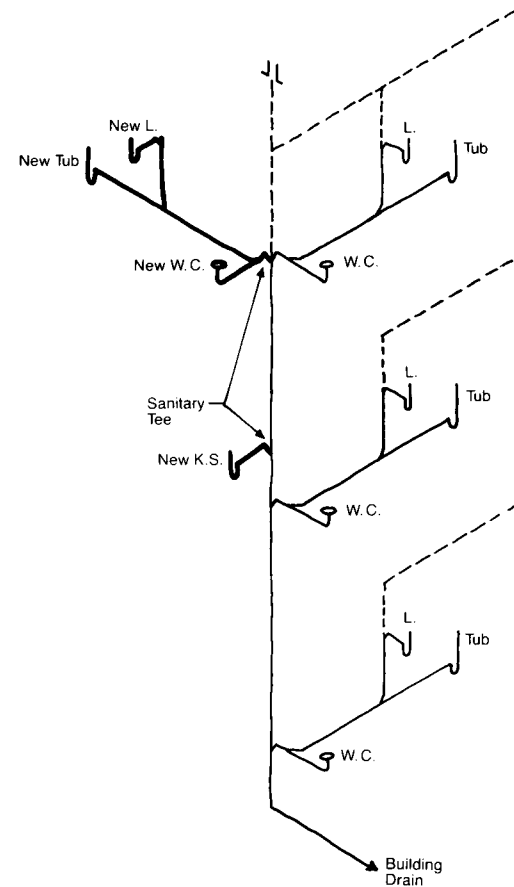

## FIGURE 8

### Addition of Second Floor Fixture to Existing Stack

A second kitchen sink, with or without disposer, may be added to an existing 2 inch waste stack. A 1½ inch fixture drain may run 7 feet maximum.

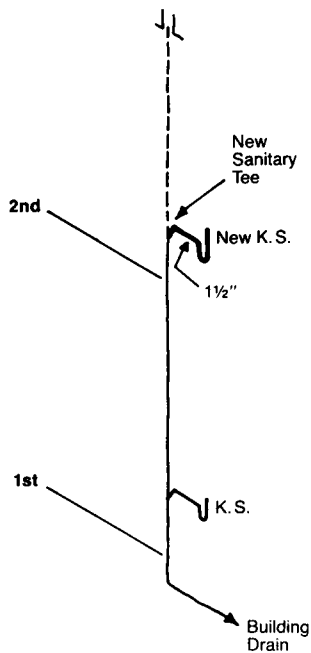

Most codes limit the pressure fluctuation within drainage systems to  $\pm 1$  inch of water pressure under design load conditions. A more practical limitation, and the one used in this guideline, is to limit the trap seal reduction to 1 inch of water under normal conditions of loading. This concept permits the planning and carrying out of simple field tests on existing systems to determine their condition and provides a basis for approving modified systems in rehabilitated buildings.

An "efficient manner" means the conveyance of waste water and suspended solids without blockage. Efficient transport is a function of both velocity and depth of flow. The generally accepted criteria to ensure efficient performance is to size the horizontal drainage lines such that the velocity of flow is approximately 2 feet per second.

If the depth is not sufficient for a given velocity, solids will settle out. The depth of flow and water velocity are both influenced by the slope or pitch of the drain line. Increasing the slope from 1/8 inch per foot to 1/4 inch per foot increases the velocity of the water while it decreases the depth of flow. Knowledge and understanding of these characteristics of flow provides the basis for adjusting the slope of existing building drains, which often determines the capacity of the plumbing drainage system.

### Hydraulic Principles

The rate and volume of spent water discharged from plumbing fixtures and drains, as well as the frequency of fixture use, are important variables to understanding the functioning of a DWV system. Frequency of fixture use is high in public buildings (e.g., stadiums and theaters) and low in residential buildings. Rarely will all fixtures be operated simultaneously, so fixture use in residential buildings can be estimated as the maximum number and combination of fixtures that may discharge simultaneously. In larger buildings, the fixture unit concept is employed. Existing DWV systems are not normally loaded to capacity; therefore, they will usually accept a limited number of additional fixtures without adversely affecting the system's performance.

The rate at which water exits from plumbing fixtures changes continuously. For water closets, the discharge typically begins a

few seconds after the flush is started and gradually rises to a peak rate of approximately 30 gallons per minute, remains constant for a few seconds, and then gradually falls to zero. The use of water saving closets does not increase drainage problems since their peak discharge rate is similar to conventional fixtures. The discharge time for a typical lavatory is approximately 12 seconds and the peak flow rate is about 10 gallons per minute. This low flow rate and short duration suggest that lavatories have only a small influence on the functioning of the DWV system. Bathtub discharge is influenced significantly by the geometry of the outlet piping, and may significantly affect the DWV system due to the long duration of the discharge flow. In most outlet arrangements, the rate of discharge rises to approximately 12 gallons per minute almost instantly and thereafter decreases continuously as the tub drains. Water conserving shower heads reduce flow rates, thereby improving the effects of bathtub discharge characteristics on the DWV system.

### Flow in Drains and Stacks

The flow of spent water in horizontal drainage systems may be described as separated flow since the horizontal drain is generally only partially filled. Water moves through the lower part of the pipe, while air flows through the upper part.

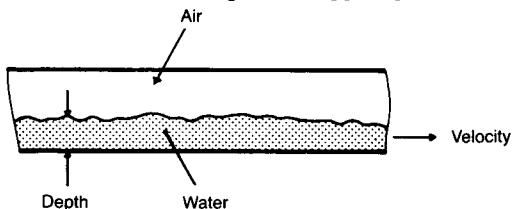

The velocity and depth of the water flow in horizontal drains changes continually. As the volume of water increases, the depth of flow also increases, displacing the air above it. When most of the air space is filled with water, turbulence increases significantly, and even small water pulsations disturb trap seals in the system's plumbing fixtures. Therefore, horizontal drains are designed to flow no more than half full.

The flow in vertical drains or stacks is entirely different. As water enters the stack it attaches itself to the walls of the pipe, forming an annulus. This cylinder of water falls down the pipe, dragging air along with it.

**FIGURE 7**

### Addition of Second Floor Fixture to Existing Stack

A lavatory and bathtub may be added to the second floor of a stack vented bathroom group. Two inch diameter tub drain may run 10 feet maximum.

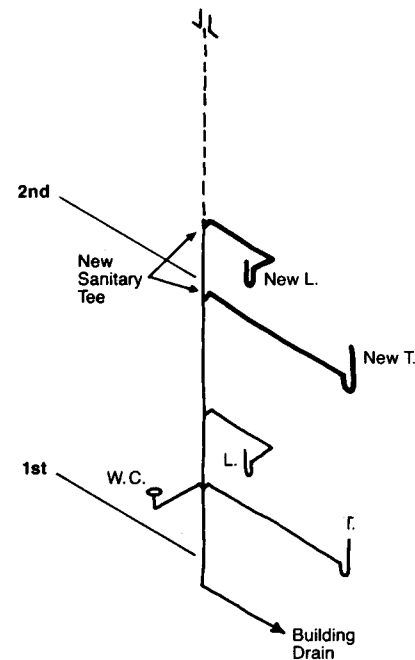

**FIGURE 6**

Addition of First Floor Powder Room of Single Dwelling Unit, with Basement  
 Illustration of use of wet venting in solving a problem of the type discussed under 2.3. For possible use of single stack solutions, see 1.3(4) and discussion under 2.3.

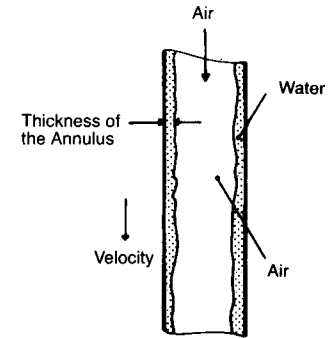
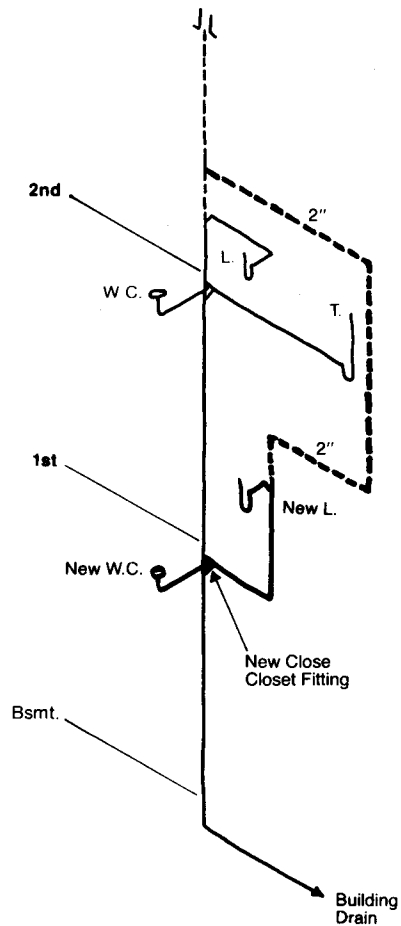

Annular flow is established rapidly within several feet of the point where the water enters the pipe. Increasing the volume of water increases the annulus thickness. When the volume of water occupies approximately 1/3 of the cross-sectional area of the pipe, the annular flow breaks down, causing extreme turbulence and pulsations which may result in the loss of trap seals. Small diameter vertical pipes close to fixture outlets are susceptible to breakdown of the annular flow which may result in self-siphonage of the fixture. It is for this reason that S traps have been prohibited by codes.

The most critical area in a drainage system is at the base of the stack. In this region the flow must change from the annular flow of the stack to the separated flow of the horizontal drain.

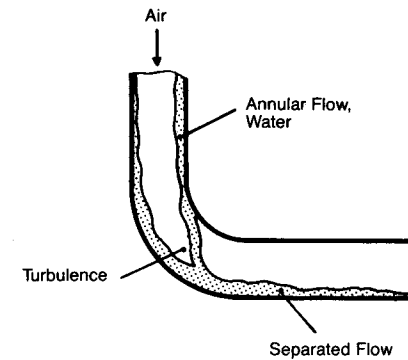

The disturbance at the base of the stack may be large, and significant positive pressures may be generated which, if not relieved, can cause blowback--the reversed passage of water through the trap. If the transition is smooth, much of the air is carried away through the horizontal drain.

Horizontal drains are not able to transport spent water at the same velocity as stacks. This results in a phenomenon called hydraulic jump. The change in velocity from approximately 15 feet per second in the stack to 2 feet per second in the horizontal drain forces an increase in the depth of flow. Recent laboratory tests find that this rise in the water level occurs much further downstream than the generally accepted 10-pipe diameters. What has been observed in the immediate vicinity of the base of the stack is a washing of the sides of the drain which may cause temporary blockage of fixture drains or vents that enter nearby. Fittings rolled up to 45 degrees are effective in avoiding problems in this area.

### Modes of Trap Failure

The traps of a drainage system may fail by one or more of the following means:

- self-siphonage, or reduction of the trap seal as a result of siphonic action by the discharge of the fixture to which the trap is connected;
- induced siphonage, or reduction of the trap seal as a result of siphonic action by discharge of fixtures other than the one to which the trap is connected;
- blowback, or the emission of water, air, sewer gas, or suds into the fixture or the inhabited area of a building through the fixture trap; or
- cross-flow, or the movement of waste water from the trap, trap area, or branch drain of an operating fixture to the trap, trap area, or branch drain of an idle fixture.

The first of these modes of failure, self-siphonage, is a function of fixture and branch piping characteristics. Plumbing fixtures

**FIGURE 5**

Addition of First Floor Powder Room of Single Dwelling Unit, Slab on Grade  
Illustration of use of wet venting in solving a problem of the type discussed under 2.3. For possible use of single stack solutions, see 1.3(4) and discussion under 2.3.

Note that new branch drain line may enter building drain on stack.

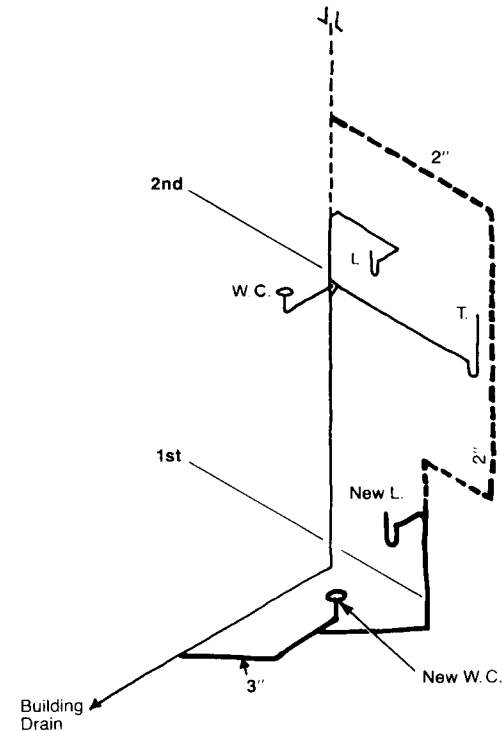

**FIGURE 4**

Island Sink with Disposer, Dishwashers, and Clothes Washer at Wall

Example of solution to problem 2.2.

Note that required location of dishwasher air gap may vary by local code.

- all pipe 2" diameter
- 1½" trap

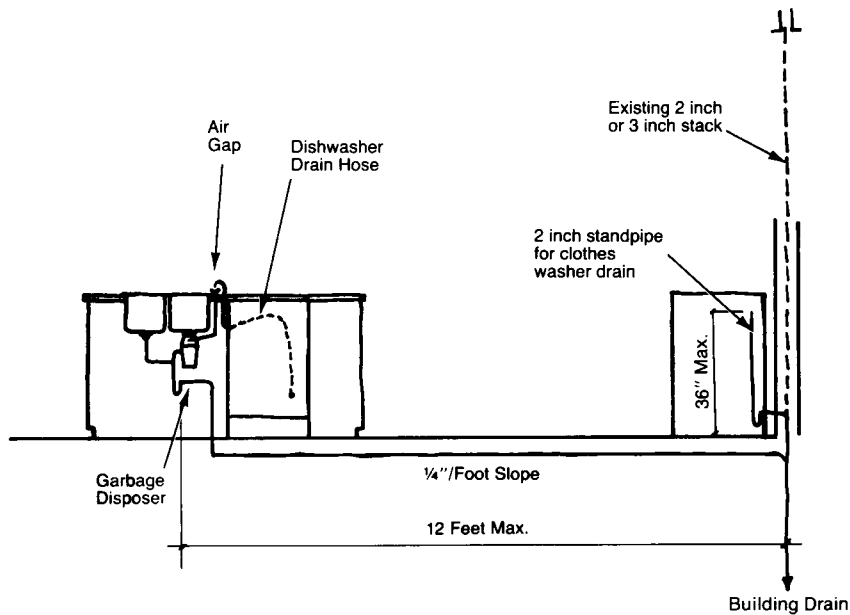

which exhibit a sharp fall off in flow (e.g., round bottom lavatories) are more sensitive to self-siphonage than those with more gradual changes in flow. Traps serving bathtubs are rarely subject to self-siphonage. Self-venting trap arms and branch drains can be designed to prevent self-siphonage through knowledge of the fixture discharge characteristics and correct pipe sizing and configuration.

Induced siphonage, blowback, and cross-flow are prevented through correct venting design and installation. Every drainage system has a basic hydraulic capacity which may be increased by the addition of vents. The function of venting is to maintain close to atmospheric pressure in the drainage system so that trap seals will not be disturbed. A sure way to protect the DWV system is to provide individual fixture vents, an obviously expensive approach. Among the more economical alternatives that have been developed, tested, and commonly approved for residential buildings are stack venting and wet venting.

In stack venting, fixture traps are protected by venting provided through the upper portion of the soil or waste stack. Successful installations require that fixtures be connected to the stack independently, in the order of their rate of discharge (those with the highest rate of discharge placed at the lowest point in the module), and at those parts of the stack where pressure fluctuations are small. Most codes allow stack venting of fixture traps on the top floor of a building.

Wet venting is a technique that uses the drain pipe itself for venting of selected fixture traps. In practice, wet vents receive only the spent water from fixtures that have a low rate of discharge. These fixtures need not enter the stack independently, and in many installations, groups of fixtures connect to a single horizontal branch. A variety of wet vented modules have been developed and accepted by various codes over the years.

Progressive plumbing designs incorporate wet vented and stack vented modules as major DWV components, supplemented by individually vented fixtures where required by design restraints.



# 1 Determination of Existing Condition of the DWV System

The condition and capacity of the existing DWV system must be determined before any informed decision can be made as to the need for and extent of rehabilitation. This determination may also be necessary to provide the authority having jurisdiction with the information necessary to evaluate a proposed DWV rehabilitation project (see the *Guideline for Approval of Building Rehabilitation*). This part of the guideline discusses inspection procedures, documentation, testing, and methods for estimating system capacity, all of which may be required to determine existing conditions.

## 1.1 Inspection, System Schematics, and Preliminary Evaluation

A field inspection of the existing DWV system should be carried out to obtain the following general information:

- Overall physical condition;
- Evidence of impaired structural serviceability and hydraulic integrity;
- System configuration and sizing;
- Existence of surcharged sewers; and
- Effects of existing structural and architectural elements, as well as the DWV system, on achieving rehabilitation design objectives (e.g., locating a vent for an island sink).

Based upon this inspection, and in conjunction with data from any available plumbing construction drawings and specifications, a schematic diagram of the DWV system should be prepared. This diagram will provide information necessary to establish the following:

- Scope of the system and related building elements;
- Nature of specific deviation from code requirements;

FIGURE 3

Island Sink with Disposer and Dishwasher at Wall

Example of solution to problem 2.2.

Note that required location of dishwasher air gap may vary by local code.

- all pipe 2" diameter
- 1½" trap

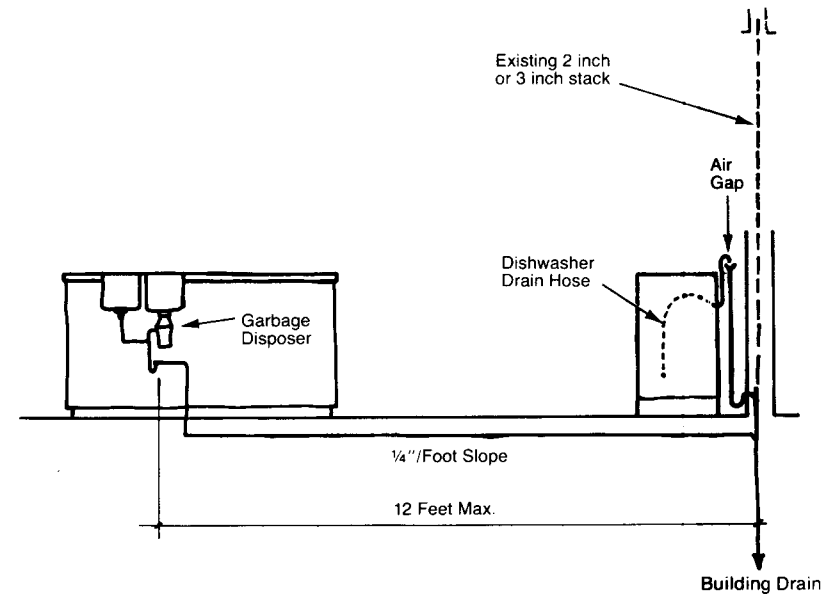

## FIGURE 2

### Island Sink

Example of solution to problem 2.2.

- all pipe 2" diameter
- 1½" trap

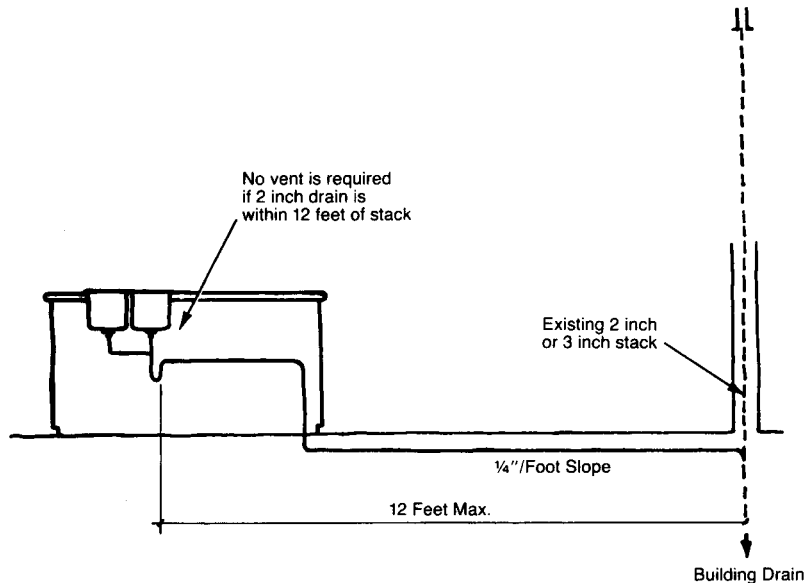

- Need for modification or amplification of the functional performance test discussed in Part 1.2 below, and the number of tests to be performed; and
- Calculation of the installed capacity and the code-permitted capacity of the installed DWV system, discussed in Part 1.3 below.

## 1.2 Testing the Existing System

### STRUCTURAL SERVICEABILITY

In most cases, physical testing to determine structural serviceability of the DWV system is unnecessary. Adequate evidence of structural serviceability may be obtained by the following:

- Careful attention to those areas where the DWV system is exposed to view;
- Evidence of exposure to freezing temperatures;
- Evidence of fire damage; and
- Careful attention to the DWV system's attachments to and penetrations of the building structure.

### HYDRAULIC INTEGRITY (WATERTIGHTNESS)

In addition to a visual inspection for hydraulic integrity, one or more of the following three tests, described briefly below, should be performed to determine the watertightness of the DWV system and to locate leaks, if any. Each of these tests will provide evidence on the watertightness of the DWV system. However, if the DWV system has been in recent and continuous use and has not developed any leaks, and if the proposed rehabilitation is not extensive, testing for hydraulic integrity may not be required.

If the DWV system and connected fixtures are intact, perform a Finished Plumbing Test. This test method utilizes a thick pun-

gent smoke so it may be impractical or difficult to perform in a partially occupied building. If a Finished Plumbing Test cannot be performed on an intact system, then perform a Flow Test. If the DWV system is not intact, perform a Rough Plumbing Test.

When available, standard test procedures included in the local plumbing code should be followed for each of the tests briefly specified as follows:

Finished Plumbing Test: The test of the intact DWV system should be performed by filling all traps with water and then introducing a thick pungent smoke into the system near the base of the stack. When the smoke appears at the vent openings, they shall be closed and a pressure equivalent to a 2 inch water column attained. This pressure shall be held for 15 minutes before inspection starts.

Flow Test: The flow test should be performed on all parts of the intact DWV system by filling each fixture within a group to its normal capacity and then discharging the spent water. Where several fixtures are connected to the same branch, the fixtures shall be discharged together.

Rough Plumbing Test: The water or air test conducted on the roughed-in plumbing shall be completed by blocking the lower portion of the system and filling the drain and vent piping with water. In tall buildings the system should be tested at intervals such that the manufacturer's working pressure for the joints is not exceeded, but no section should be tested with less than 10 feet of water except the uppermost 10 feet of the system. The water shall be kept in the system for at least 15 minutes before the inspection starts. The system shall be tight at all points. When using air as a test media, all inlets and outlets must be sealed except where the air pressure apparatus is connected to the system. Air shall be introduced until a uniform gauge pressure of 5 psi is attained. This pressure shall be held for 15 minutes without the introduction of additional air.

**FIGURE 1**

Correction of "S" Trap Subject to Self-Siphonage in Flat Bottomed Sinks

Illustration of solution to problem 2.1(5).

- A = not more than 10 pipe diameters
- B = not more than 24 pipe diameters
- C = not more than 72 pipe diameters

- all pipe 2" diameter
- 1½" trap

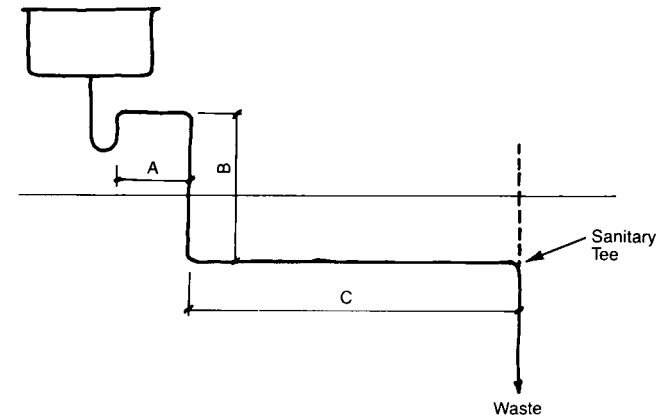



---

## Appendix B

### Examples of Acceptable DWV Practices for Building Rehabilitation

The following illustrated DWV practices have been determined to be adequate in solving problems of the type discussed in this guideline, based on engineering principles and the experience of recognized testing facilities. They do not represent all possible problems, nor do they reflect the most extreme solutions in terms of deviation from the specific requirements of plumbing codes.

#### Symbols

WC	Water Closet
T	Bathtub
L	Lavatory
KS	Kitchen Sink
	New Sanitary Piping
	Existing Sanitary Piping
	Vents

---

#### FUNCTIONAL PERFORMANCE

DWV systems with proven hydraulic integrity (i.e., as described above or repaired in accordance with Part 2.1 below) should be subjected to one or more functional performance tests unless they are in compliance with current codes (see Parts 1.1 above and 1.3 below). Functional performance tests should be carried out to determine the resistance of the DWV system to each of the following modes of failure:

- Self-siphonage;
- Induced siphonage;
- Blowback; and
- Cross-flow.

Tests for self-siphonage, and tests for induced siphonage, blowback, and cross-flow which may occur on the same floor (i.e., branch pipe testing), should be planned on the basis of analysis of the system schematics discussed in Part 1.1 above. Tests for resistance to induced siphonage and blowback on different floors (i.e., stack testing) should be carried out for each stack.

Performance tests like the one specified below, carried out in the laboratory on full-scale drainage systems, have shown that trap seal reduction by induced siphonage is greatest in those fixtures located 2 and 3 floors below the active fixtures. Blowback, the most common mode of failure, usually is observed in the ground or first floor water closets. Systems near capacity will show a trap seal reduction of 3/4 to 1 inch and/or display considerable movement of the water surface in the water closets.

Despite extensive laboratory test experience and the inclusion of performance test guidelines in the Standard Plumbing Code (Ch. XVI), standard test instrumentation and procedures have not been developed for performance testing of plumbing systems. If and when such standard methods are developed, all testing, including the performance testing recommended below, should be carried out in accordance with such methods.

---

The following clear water test is appropriate for back to back bathroom stacks up to ten stories in height.\*

Functional Performance Test for Bathroom Stacks:

Select the required test load from the table below.

The test loads are based upon a frequency of use ratio of 0.01. This frequency of use is consistent with data developed at the Davidson Laboratory and the National Bureau of Standards (see Table A5, NBSIR 73-161, *Field Test of Hydraulic Performance of a Single-Stack Drainage System at the OPERATION BREAKTHROUGH Prototype Site in Kings County, Washington*), but is significantly lower than the test loading requirements of Ch. XVI of the Standard Plumbing Code, published by the Southern Building Code Congress International, and British test loading data. For different frequency ratios and related loading requirements, see Table A5 referenced above.

<u>Building Type</u>	<u>Test Load</u>
Single family dwelling	One water closet and one bathtub
Multi-family up to four stories	Two water closets
Multi-family four to ten stories	Two water closets and one bathtub

Select fixtures for discharge that are most remote with respect to the building drain in single family homes, and vertically adjacent at the uppermost levels in multi-family dwellings.

Then, fill all fixture traps. Discharge the selected fixtures simultaneously. Observe and record the trap seal reduction in the idle fixture traps. Reduction of more than 1 inch of water is critical and should be recorded. Observe the lower floor water closets for blowback.

---

\* Increased test loads, introduction of solids and/or suds, and other points of observation should be considered for other types of stacks, based on analysis of the system schematic.

---

TEST

Determine compliance with the criteria above by the following test methods, respectively:

- (1) Functional Performance Tests (see Part 1.3 above).
- (2) Conformance with Standard Plumbing Code, Chapter XVI.
- (3) Conformance with local code or SBCCI or BOCA research reports.
- (4) Conformance with NBS Building Science Series, No. 60.
- (5) Conformance with code requirements.

DISCUSSION

Compliance with this requirement can always be achieved by the addition of supplemental venting in DWV systems failing this test.

---

## 6. Functional Performance

### REQUIREMENT

The DWV system shall accept and transport spent water and liquid in a safe and efficient manner.

### CRITERIA

(1) The DWV system shall not, under conditions of normal use, display any of the following failures:

- Self-siphonage at any fixture trap;
- Trap seal reduction greater than 1 inch, indicating induced siphonage;
- Evidence of blowback at any fixture;
- Ejection of suds at any fixture; or
- Evidence of cross-flow in any branches of back to back fixtures.

(2) Single stack DWV systems shall be deemed to conform to this performance guideline if designed in accordance with the Standard Plumbing Code, Chapter XVI, Section 1602.

(3) Automatic anti-siphon trap vent devices may be used in the DWV system as permitted by the local plumbing code or as detailed in a SBCCI or BOCA research report.

(4) Reduced sized venting may be used in the DWV system of buildings under three stories in height, provided that the entire system shall be designed by a professional engineer familiar with plumbing design in accordance with criteria and guidelines contained in the NBS publication, Building Science Series, No. 60, *Hydraulic Performance of Full Scale Townhouse System with Reduced-Size Vents*, August 1975.

(5) Code-accepted, proprietary, engineered single stack DWV systems shall be designed and installed in accordance with the conditions of their acceptance.

---

## 1.3

### Estimating the Capacity of the Existing DWV System

The installed capacity of the existing DWV system should be estimated for two reasons. First, by comparing it to the code-permitted capacity, potential code-related problems will become evident. Second, the estimated capacity is an indication of the system's potential for accepting additional fixtures to be installed as part of the proposed rehabilitation.

The following procedure should be followed:

Identify and count all fixtures connected to each DWV stack. Translate the fixture count into fixture unit values, based on the following table:

Fixture	Fixture Units
Automatic clothes washer	3
Bathtub (w/ or w/o overhead shower)	2
Bathroom group (incl. tank type w.c.)	6
Bathroom group (incl. flushometer valve w.c.)	8
Dishwasher	2
Floor drain	2
Kitchen sink (w/ or w/o food-waste grinder)	2
Lavatory	1
Laundry tray	2
Shower stall	2
Sink, service type with floor outlet	3
Sink, service type with P-trap	2
Water closet (tank type)	4
Water closet with flushometer valve	8

Based on the system schematic (Part 1.1 above), identify the existing size of the stack and size and slope of the drain, as well as code required sizes.

Based on the system schematic, determine the type of venting. For the purpose of simplification, the type of venting falls into three categories: single stack with no secondary vents, vents of "unknown" condition, and code-compliant vents.

Vents of "unknown" condition are vents which may be partially blocked, or are otherwise of lesser venting than code-compliant vents.

Based upon the information from the steps above, estimate the fixture unit capacity of the DWV system from the following table (Note: this table applies to back to back vertical stack arrangements only):

Stack size	Building Drain Size @ 1/4" slope* per foot	Allowable number of fixture units		
		Single stack**	Vents of "unknown" condition†	Code-compliant vents
3"	4"	15††	30††	72††
4"	4"	96	150	216
4"	5"			480
5"	5"			480
5"	6"			840

\* If slope exceeds 1/4" per foot, capacity will increase.

\*\* Capacity of single stack as found in an existing building. This capacity may be exceeded with engineered single stack systems subjected to final performance tests. Single stack systems are not recommended in locations where building drains are subject to flooding under normal conditions.

† The listed capacities may be exceeded if the system does not fail when subjected to final performance tests.

†† Not more than 3 stories, nor more than 6 water closets.

## 2 Problems and Solutions (Proposed Modifications)

### 2.1 Correcting Existing DWV System Structural, Hydraulic, and Functional Defects, and Surcharged Sewers

#### 2.1.1

Problem: The inspection of the existing DWV system (Part 1.1 above) reveals that the mechanical strength of existing pipes,

specifications, inspection of built elements, and conformance to good engineering and trade practices.

### 4. Structural Serviceability

#### REQUIREMENT

The DWV system shall be capable of withstanding the physical forces that may reasonably be expected in the building during the rehabilitation process and in subsequent use.

#### CRITERIA

- (1) The mechanical strength of new pipe, fittings, and supports shall be similar to that of new construction.
- (2) The DWV system elements shall be securely attached to the building.
- (3) DWV piping shall not be subject to dead or live loads above normal service loads.

#### TEST

Determine compliance by evaluation of the installation.

### 5. Hydraulic Integrity

#### REQUIREMENT

The DWV system shall be air and water tight under conditions of *normal use*.

#### CRITERIA

- (1) The major elements of the DWV system (building drains, stacks, and horizontal branches) shall be leak tight when subjected to a pressure of 5 psi.
- (2) The completed DWV system shall be leak tight when subjected to a pressure equivalent to a 2 inch water column.

#### TEST

Determine compliance with Criteria (1) by the Rough Plumbing Test and with Criteria (2) by the Finished Plumbing Test (see Part 1.2 above).

---

(3) The installer should observe the manufacturer's good practice recommendations regarding handling, storage, installation, and adjustment of materials and equipment so that the performance of such products will not be impaired by defects or damage.

#### TEST

Determine conformance by inspection of installation and materials and conformance to good trade practices.

### 3. Maintainability

#### REQUIREMENT

The design and installation of the DWV system shall provide for cleaning and servicing of the various elements and shall minimize conditions that contribute to soiling, deposition, fouling, clogging, or other maintenance problems.

#### CRITERIA

(1) Horizontal drains shall be installed in uniform alignment at a slope in the direction of flow of at least 1/4 inch per foot for diameters of 4 inches and greater to obtain self-scouring velocities. Where such slopes are not attainable, lesser slopes may be used if a mean velocity of at least 2 feet per second can be computed for open channel steady flow at an assumed depth equal to 1/2 of the diameter.

(2) Access to permit convenient removal of obstructions and fouling matter in horizontal drain lines shall be provided as follows:

- Not more than 100 feet apart for larger pipes;
- At each change of direction of the building drain in excess of 45°;
- At or near the foot of each vertical soil or waste stack; and
- Near the junction of the building drain and building sewer.

#### TEST

Determine conformance by evaluation of calculations, plans and

---

fittings, and supports is appreciably lower than that required for new construction and/or the DWV system is inadequately attached to the building. These conditions may be evidenced by:

- Extensive corrosion, scale, and other deterioration of wall thicknesses;
- Pipe movement, misalignment, and nonuniform slope;
- Joint separation;
- Other indications of failure;
- Evidence of exposure to freezing temperatures;
- Evidence of excessive thermal expansion and contraction; or
- Evidence of fire damage.

Solution: Removal or repair of the damaged parts.

Discussion: Age alone is not indicative of the condition of a plumbing drainage system. Many systems have been found to be in excellent physical condition after decades of service.

#### 2.1.2

Problem: Reduced clearances in sleeves and supports, pipe deflection, or other like evidence indicates that the DWV system has been subjected to excessive live or dead loads, above normal service loads.

Solution: Remove such live or dead loads and repair or replace damaged parts.

#### 2.1.3

Problem: The test(s) for hydraulic integrity (see Part 1.2 above) reveals that all or part of the DWV system is not watertight.

Solution: Repair or remove parts of the DWV system as needed to bring it to a condition of watertightness under the subject tests.



---

#### 2.1.4

**Problem:** The functional performance tests (see Part 1.2 above) result in a trap seal reduction of more than 1 inch of water (induced siphonage), and/or blowback, self-siphonage, or cross-flow are observed in the DWV system, indicating a functional deficiency.

**Solution:** Modify the DWV system, in accordance with Part 2.3 of this guideline, to a condition where it meets all the functional performance tests (see also the discussion of Basic Drainage and Hydraulic Concepts above).

#### 2.1.5

**Problem:** Self-siphonage is observed in an S trap that is subjected to a functional performance test.

**Solution:** Modify the fixture so that the distance between the trap outlet and the vertical drop is at least two pipe diameters, but only if the size of the vertical pipe is one diameter larger than the trap inlet (see also Appendix B, Figure 1 for additional information on acceptable practices).

**Discussion:** The concern for self-siphonage of S traps has led to their prohibition by codes. Self-siphonage in S traps can be eliminated by the modification described above, which is consistent with National Standard Plumbing Code §12.8.2, published by the National Association of Plumbing-Heating-Cooling Contractors.

#### 2.1.6

**Problem:** The drainage system of the building is subject to backflow from the public sewer system.

**Solution:** Approved suitable means such as sewage ejectors, isolation of basement drainage, and backwater valves should be employed to prevent backflow from entering the building.

### 2.2

#### Relocating Fixtures

**Problem:** The proposed rehabilitation, when the existing DWV system is without structural, hydraulic, or functional defects and has adequate capacity for its installed fixtures (see Part 1.3 above), involves the relocation of fixtures without any additional

---

(7) Fittings, devices, connections, and methods of installation shall not obstruct or retard the normal flow of fluids in soil, waste, or vent lines.

(8) Waste water or waterborne solids from an active drain pipe shall not pass through an idle trap to a fixture.

(9) Suitable means shall be provided for handling drainage below sewer level. Where discharge from part(s) of the drainage system cannot drain by gravity into the sewer, it shall be disposed of through a separate drainage and sewage ejector system and discharged into the building gravity drainage system.

#### TEST

Determine conformance by evaluation of calculations, plans, and specifications, inspection of built elements, and conformance to good engineering and trade practices.

#### DISCUSSION

These criteria have been derived from experience and research on plumbing hydraulics at the Davidson Laboratory, Stevens Institute of Technology, or from standard design practice in general acceptance.

### 2. Durability

#### REQUIREMENT

The DWV system and its parts shall have a reasonable life expectancy as determined by the local jurisdiction.

#### CRITERIA

(1) New DWV equipment and systems shall be made of materials approved for new construction, free from defects, and designed and installed so as to be durable, without need for frequent repairs or major replacements.

(2) Before proceeding with an installation, the installer should consult with the local building department to determine the durability of materials and joints used under local conditions.

---

## Appendix A Performance Criteria

The following Performance Criteria are referenced in Part 2.3 above.

### 1. Transport of Wastes

#### REQUIREMENT

Waste water and sewage shall be removed from the building and transported to an acceptable point of disposal without overflowing, accumulating, or backing up into fixtures.

#### CRITERIA

- (1) Drainage stacks shall carry design loads when flowing less than 1/3 full at terminal velocity.
- (2) Horizontal branch drains and building sewers (except horizontal fixture drains) shall flow no more than approximately 1/2 full under design loads. Horizontal fixture drains shall be sized to give an optimum balance between scouring velocity, diameter, and carrying capacity.
- (3) Maximum lengths of unvented fixture drains having a slope of 1/4 inch per foot shall be in accordance with the table in Part 2.2 above.
- (4) Waste lines likely to carry grease (especially kitchen lines of 2 inch diameter or less) shall not pass through spaces where they may be subjected to temperatures below the ambient temperature of the occupied space, and all waste lines shall not be subjected to freezing temperatures, unless they are adequately protected.
- (5) Vents shall not connect to horizontal drains unless the bases of such vent connections are washed by the discharge from one or more small fixtures.
- (6) A uniform, continuous grade of the invert of horizontal drain lines shall be provided.

---

load being imposed on the system. However, the length of unvented horizontal fixture drain between the proposed fixture and existing vertical drain exceeds that allowed by the local plumbing code.

Solution: For bathroom groups, allow fixture drain lengths having a slope of 1/4 inch per foot up to the maximum indicated in the following table, provided the connection to the stack is with a sanitary tee or a long turn TY:

Maximum Developed Length of Unvented Fixture Drains

Diameter of Drain	Length
1-1/4"	5'
1-1/2"	7'
2"	10'
3"	12'
4"	20'

For kitchen (flat bottomed) sinks with or without dishwasher and garbage disposer, allow drain lengths having a slope of 1/4 inch per foot up to 12 feet with 2" drain (see Appendix B, Figures 2, 3, and 4).

Discussion: The concern for self-siphonage in fixtures has led to limitations on lengths of unvented fixture drains. Existing distances as specified in codes may impose a severe restriction on rehabilitation. The smaller diameter fixture outlets of modern installations have reduced flow rates and suggest the acceptability of longer permissible fixture drains.

The data in the table above is based on the following reports: *Test on Branch Layouts--Investigation of Minimal Tube Diameter*, by O. H. C. Messner, Zurich, Switzerland, April, 1970; and *An Investigation of the Safety and Durability of the Plumbing Systems in Mobile Homes*, Report SIT-DL-79-9-2079, Stevens Institute of Technology, Hoboken, N. J. (to be published).

The recommended kitchen unit drain lengths are based on *Plumbing Manual*, BMS-66, U. S. Government Printing Office, 1940.

---

### 2.3 Adding New Fixtures to Existing DWV Systems, Extending DWV Systems, and/or Installing New DWV Systems in Existing Buildings

**Problem:** The proposed rehabilitation, when the existing DWV system is without structural, hydraulic, or functional defects, involves any combination of the following activities:

- Adding new fixtures to the existing DWV system when its capacity exceeds its installed fixtures (see Part 1.3 above);
- Extending the existing DWV system when its capacity exceeds its installed fixtures (see Part 1.3 above); or
- Installing new DWV systems in an existing building (whether or not the existing system will continue in use).

However, full compliance with current plumbing codes requires extensive structural or architectural changes causing unwarranted additional costs and delays to the rehabilitation project.

**Solution:** All additions and alterations to existing plumbing DWV systems should be designed and installed in accordance with Performance Criteria (see Appendix A) covering the following six attributes of the system:

- Transport of Wastes
- Durability
- Maintainability
- Structural Serviceability
- Hydraulic Integrity
- Functional Performance

Alternative acceptable solutions may be found in the following documents:

- Standard Plumbing Code, Chapter XVI, Section 1602--Single Stack Discharge Ventilating Pipe Systems;
- Southern Building Code Congress International (SBCCI) and Building Officials and Code Administrators International (BOCA) research reports for automatic anti-siphon trap vent devices; and

- 
- NBS Building Science Series, No. 60, *Hydraulic Performance of a Full Scale Townhouse System with Reduced-Size Vents*, August 1975, for reduced sized venting design.

Appendix B illustrates typical solutions which will comply with the Performance Criteria under most conditions of operation and use, based upon engineering analysis and interpretation of test results.

**Discussion:** Single stack DWV systems, even when fully complying with the Performance Criteria, are not recommended in locations where building drains are subject to flooding under normal conditions.

### 2.4 Through-the-Wall Venting

**Problem:** An existing DWV system, an addition to an existing DWV system, or a new DWV system in an existing building may include through-the-wall rather than roof venting. This condition, which may be determined by inspecting the building or examining existing and/or proposed plans, is likely to be prohibited by the local code.

**Solution:** Through-the-wall venting should be accepted in the following instances:

- In an historic building where through-roof venting would interfere with the character of the building.
- In rehabilitation projects where conventional venting is impractical. In this case, the vents should be at least 10 feet horizontally from the lot line and should be turned downward. They should be effectively screened with 1/4 inch mesh to avoid trapping and freezing of any condensation. Through-the-wall vent openings should not be located directly below any door, window, or other building opening, nor should any such vent terminal be within ten feet horizontally of such an opening unless it is 2 feet above the top of such opening.